



Quality by Witzemann

THE GROUP

With 24 companies in 19 countries
Witzemann is number 1 in the industry worldwide.

World leader

Witzemann is a global group of companies that specialises in flexible metallic elements. Our company is renowned as an innovative development partner and reliable manufacturer within the industry thanks to our vision of "managing flexibility". Today Witzemann offers the widest range of products for the most diverse areas of application. This enables us to offer the correct solutions time and time again.



Witzemann-Speck GmbH

Werner-Siemens-Str. 2
75249 Kieselbronn, Germany
Telefon +49 7231 9517-0
Fax +49 7231 9517-72
wsp@witzemann.com
www.witzemann-speck.de



WITZENMANN
managing flexibility

FLEXIBLE ELEMENTS FOR FIRE PROTECTION



CONTENT



HYDRA® Sprinkler Mounting Systems 4

Cost and Installation Advantages	6
The Standard Programme	7
The Programme for Special Mountings	8
Technical Data Overview	10
HYDRA® Sprinkler Mounting System Type 1	12
Installation Situation Type 1	13
HYDRA® Sprinkler Mounting System Type 2	14
Installation Situation Type 2	15
HYDRA® Sprinkler Mounting System Type 4	16
HYDRA® Sprinkler Mounting System Type 5	17
Installation Situation Type 5	18
HYDRA® Sprinkler Mounting System Type 6	19
HYDRA® Sprinkler Mounting System Type 7	20
HYDRA® Sprinkler Bracket L Type 11	21
HYDRA® Sprinkler Bracket L Type 12	22
HYDRA® Sprinkler Bracket L Type 13	23
HYDRA® Sprinkler Bracket L Type 10/15	24
HYDRA® Sprinkler Brackets	25
Design And Planning	26

HYDRA® Stainless Steel Hoses 30

HYDRA® Stainless Steel Hoses	32
Connection Fittings	36

HYDRA® Axial Expansion Joints 37

HYDRA® Axial Expansion Joints	38
HYDRA® Lateral Expansion Joints	41

HYDRA® SPRINKLER MOUNTING SYSTEMS

HYDRA® Sprinkler systems stand for quality made by Witzemann. This implies dependability and long life cycles as well as fast and simple mounting.

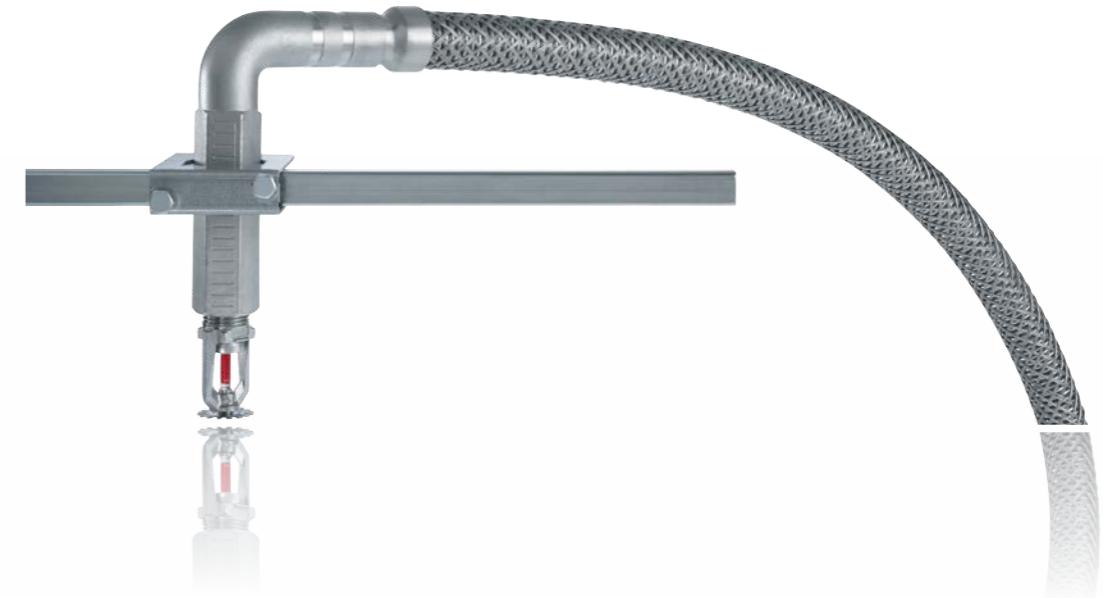

The exact mounting of sprinklers in suspended ceiling systems using conventional mounting methods is a very laborious job. The traditional "lining up" using rigid piping according to the predefined ceiling plan is very time consuming and costly.

Using a specially pre-assembled stainless steel hose significantly minimises the efforts required for installation purposes, because the hose's flexibility enables you to freely choose the installation position of the sprinkler within a circular area defined by the hose length. This makes it possible to precisely position sprinklers in suspended ceiling systems of various designs with ease.

Compared to the conventional installation technology used to date, this saves significant time and costs. The supplied mounting brackets allow for a reliable and secure attachment of the sprinkler hose to the respective ceiling system substructure.

Benefits

- Delivery service: 48h ex warehouse/24h express (within Germany)
- The system with the most flexible metal hoses (quick and easy installation)
- Vast experience of Germany's market leader
- Sound technical advice
- Engineering and development competence

COST AND INSTALLATION ADVANTAGES



Flexible sprinkler mounting systems

- Fast and easy installation thanks to flexible metal hoses and all-in-one system incl. bracket and installation technology
- Scaling allows quick sprinkler positioning
- Easily bypass other building components and assemblies
- Does not require completely new installation of sprinkler system during renovations or conversions
- Variable positioning in all directions possible
- Very quick installation (only 7-8 minutes for each sprinkler system), making it considerably faster and more cost-effective
- Lower labour requirements
- Leaks can already be detected during installation
 - when the building is still just a shell construction.
 - Prevents expensive water damage.

Costs

Witzenmann's flexible sprinkler mounting system enables you to work considerably faster than with rigid piping, allowing you to do more in the same time.

Sample project

Office building with an average number of floors
 Installation of 300 sprinklers
 System: Standard lay-in ceilings
 Number of installers: 4

Reduction in overall costs: 25 – 30 % less
Reduction in installation time: 70 – 80 % less

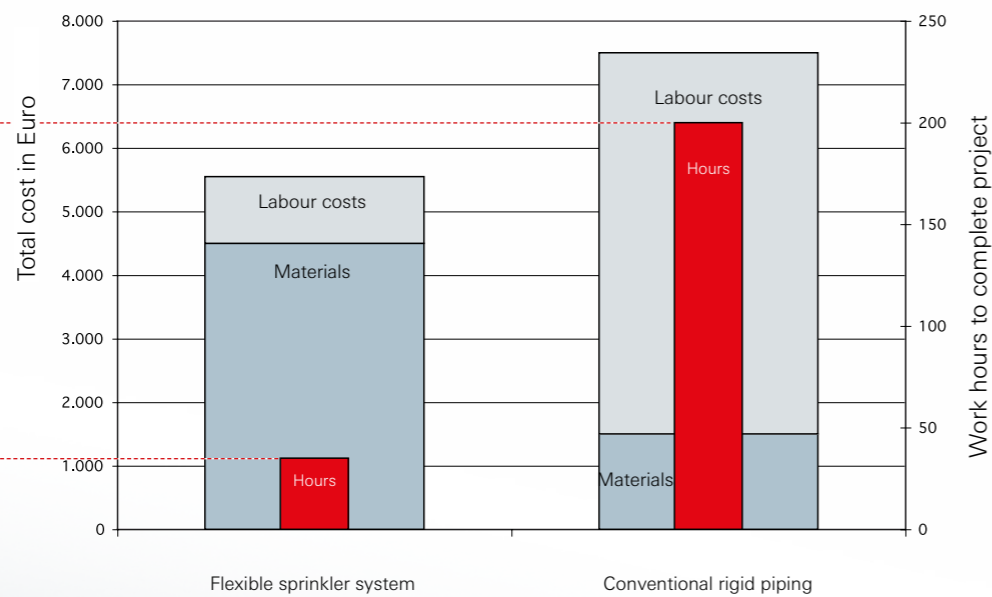

Reduction in Installation time 70 - 80%

THE STANDARD PROGRAMME

Sprinkler mounting system



The square pipe serves as the supporting base

Standard HYDRA sprinkler brackets are based on using a square pipe 15 x 15 mm as a transverse beam, which is available in different lengths (standard length 700 mm). The HYDRA sprinkler hose is fastened to the square pipe using a sprinkler clamp, which can be moved over the entire length of the square pipe. Various types are available – the installation technology is adapted to the construction of the suspended ceiling.

Delivery scope for the standard mounting system

- 1 Sprinkler hose, type RS 339L92, DN 20 / DN 25,
- 1 Square pipe 700, 1400, 2000 mm (other lengths available on request)
- 1 Movable sprinkler clamp, closed
- 2 Mounting clips of the respective type

Holder kit



Approvals

Sprinkler mounting systems are recognised by the VdS (Association of Damage Insurers of Germany) and approved for use in sprinkler wet systems with sprinklers R 1/2" (K 80) and R 3/4" (K 115) in the pressure level PN 16 bar. The approval is only valid in connection with the ceiling systems specified in our technical product descriptions.

FM-approved sprinkler mounting systems are available in the pressure level PN 12 bar (175 psi) for sprinklers R 1/2" (K 80) and R 3/4" (K 115). The sprinkler mounting systems also have CNPP (France) and ANPI (Belgium) approvals.

Mounting view



Areas of application

- Grid ceilings with T-bars
- Ceiling systems: plasterboard, sheet metal panel, clamping profil
- Clean room filter ceiling systems
- Modular grid ceiling constructions
- Aluminium meshed metal baffle ceilings

Approved solutions are available for ceiling systems by the following manufacturers

Our Approvals



- | | | |
|--------------------------|--------------------------|--------------------|
| ■ AMF | ■ Gema-Armstrong | ■ Odenwald |
| ■ Armstrong | ■ Hilti | ■ Richter-System |
| ■ Daldrop & Dr. Huber | ■ Knauf | ■ Rigips |
| ■ Dampa Chicago Metallic | ■ Lafarge | ■ Rockfon Pagos |
| ■ Dipling | ■ Lindner | ■ Schmid GmbH |
| ■ Durlum | ■ M & W Zander | ■ Suckow & Fischer |
| ■ Geipel | ■ Nagelstutz und Eichler | ■ USG Donn |

THE PROGRAMME FOR SPECIAL MOUNTINGS

Hose with opened sprinkler clamp



Mounting on square pipe



HYDRA sprinkler mounts are available with closed or open and fold-away sprinkler clamps. The fold-away sprinkler always allows you to easily fasten sprinkler hoses on the square pipe – even with pre-mounted spring washers and/or sealed sprinklers with large baffles.

Our Approvals



Subsequently detachable, closed clamp

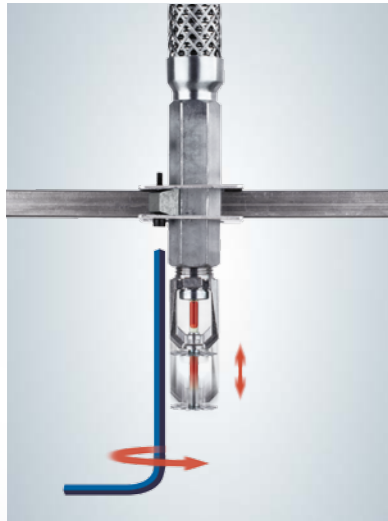

In individual cases, the sprinkler heads must be adjusted again after completely installing the sprinkler system and closing the ceiling. The subsequently detachable, closed sprinkler clamp – material number 1213536 – enables this final adjustment, without having to open the ceiling once again.

The system consists of the closed clamp and a wedge, which is prestressed in the clamp with a screw (wedge compression) in the delivered state.

The sprinkler hose is installed in usual manner of the HYDRA Standard mounting system. **Make sure that the screw head of the wedge compression is pointing downwards!**

Afterwards, the ceiling is closed. For subsequent adjustment use a long Allen key (size 3 for Allen screws M4) to loosen the wedge compression far enough so that the hexagon socket can be moved with the sprinkler head. After reaching the desired position, tighten the wedge compression once again until a tight fit is reached. When doing so, do not exceed the maximum torque of 3 to 3.5 Nm.

Information

The screw of the wedge compression should only be loosened a little bit so that it remains in the thread of the sprinkler clamp. If it should fall out there, mounting is no longer possible.

Our Approvals



THE PROGRAMME FOR SPECIAL MOUNTINGS

Square pipe in an offset version



We offer a suitable bracket solution for virtually every application. Special constructions and engineering solutions are available on request.

A selection of additional HYDRA sprinkler brackets

- For department store, meshed metal baffle or clean room ceilings
- For mounting directly onto profile rails
- For clean room filter ceiling systems
- For modular grid ceiling systems
- For metal panel ceiling systems

Additional sprinkler hose solutions

In addition to the standard programme, we also offer hoses with other connection types. They can be combined with all HYDRA sprinkler brackets.

- ① Sprinkler hose, straight design with **swivel** threaded connection
- ② Sprinkler hose with 90° bend with **swivel** threaded connection

Additional accessories

Square pipe in offset version 700 mm

Our Approvals

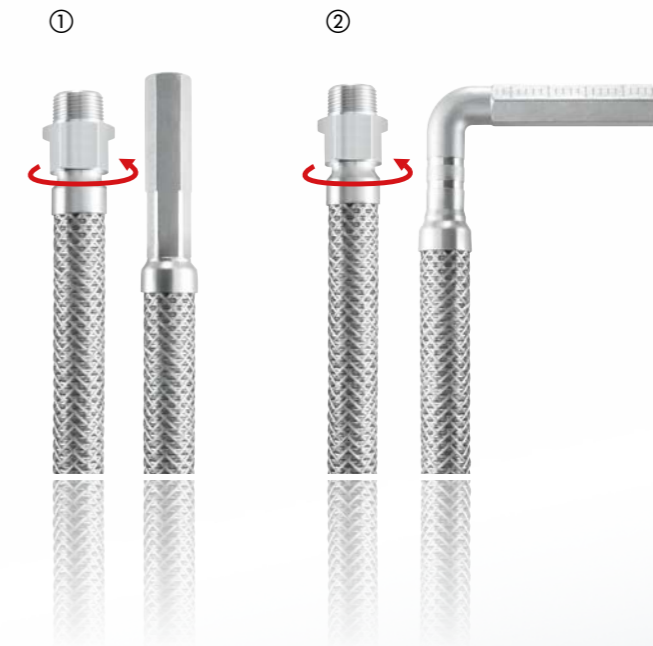

TECHNICAL DATA OVERVIEW

The standard programme

Straight design

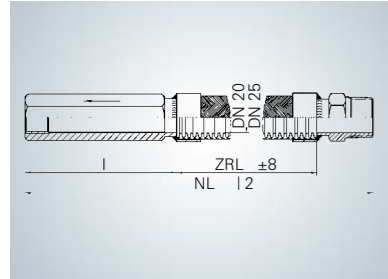

Sprinkler hose

Type RS 339L92, DN 20/DN 25, flexible design with braiding, completely made of stainless steel, welded fittings

Sprinkler connection, straight design

Stainless steel hexagon-socket = 125 mm with pipe thread as per DIN EN 10226-1 (ISO 7/1), Rp 1/2" or Rp 3/4".
Scaling for simple vertical sprinkler alignment.

90°-bend design

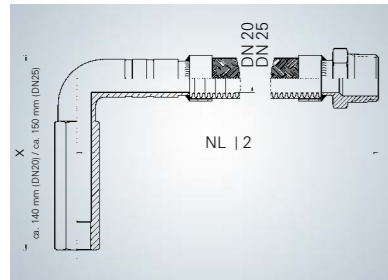

Sprinkler connection, 90° bend design

90° stainless steel bend with pipe thread as per DIN EN 10226-1 (ISO 7/1), Rp 1/2".
Scaling for simple vertical sprinkler alignment. Used for confined installations.
Installation height (x) only 140 mm (DN 20) or 150 mm (DN 25) above lower edge of suspended ceiling.

Connection to water supply line

Hexagonal nipple with pipe thread as per DIN EN 10226-1 (ISO 7/1), R 3/4" or R 1", rigid or rotating connection available.

Nominal length

NL 800 / 1000 / 1200 / 1500 / 2000 (other lengths on request)
Max. length for FM approval: NL 1800

Operating pressure

PN 16 bar, 100% tightness testing at plant with 24 bar nitrogen under water

Pressure losses

Equivalent pipe lengths are based on the specific requirements stipulated by the pertinent approval offices. You can find detailed information on page 28/29.

Our Approvals



TECHNICAL DATA OVERVIEW

The standard programme

DN	Nominal length	Sprinkler outlet	Sprinkler connection	Pipe connection	Minimum bending radius for single bending	Approx. weight when filled with water including mounting bracket
			DIN EN 10226-1			
20	800 mm	straight	Rp 1/2"	R 3/4" / R 1"	70 mm	approx. 1,8 kg
20	1000 mm	straight	Rp 1/2"	R 3/4" / R 1"	70 mm	approx. 2,0 kg
20	1200 mm	straight	Rp 1/2"	R 3/4" / R 1"	70 mm	approx. 2,2 kg
20	1500 mm	straight	Rp 1/2"	R 3/4" / R 1"	70 mm	approx. 2,4 kg
20	1800 mm	straight	Rp 1/2"	R 3/4" / R 1"	70 mm	approx. 2,6 kg
20	2000 mm	straight	Rp 1/2"	R 3/4" / R 1"	70 mm	approx. 2,8 kg
20	800 mm	90°-bend	Rp 1/2"	R 3/4" / R 1"	70 mm	approx. 2,0 kg
20	1000 mm	90°-bend	Rp 1/2"	R 3/4" / R 1"	70 mm	approx. 2,2 kg
20	1200 mm	90°-bend	Rp 1/2"	R 3/4" / R 1"	70 mm	approx. 2,3 kg
20	1500 mm	90°-bend	Rp 1/2"	R 3/4" / R 1"	70 mm	approx. 2,6 kg
20	1800 mm	90°-bend	Rp 1/2"	R 3/4" / R 1"	70 mm	approx. 2,8 kg
20	2000 mm	90°-bend	Rp 1/2"	R 3/4" / R 1"	70 mm	approx. 3,0 kg
25	800 mm	straight	Rp 1/2" / Rp 3/4"	R 1"	85 mm	approx. 2,1 kg
25	1000 mm	straight	Rp 1/2" / Rp 3/4"	R 1"	85 mm	approx. 2,3 kg
25	1200 mm	straight	Rp 1/2" / Rp 3/4"	R 1"	85 mm	approx. 2,5 kg
25	1500 mm	straight	Rp 1/2" / Rp 3/4"	R 1"	85 mm	approx. 2,8 kg
25	1800 mm	straight	Rp 1/2" / Rp 3/4"	R 1"	85 mm	approx. 3,1 kg
25	2000 mm	straight	Rp 1/2" / Rp 3/4"	R 1"	85 mm	approx. 3,3 kg
25	800 mm	90°-bend	Rp 1/2"	R 1"	85 mm	approx. 2,3 kg
25	1000 mm	90°-bend	Rp 1/2"	R 1"	85 mm	approx. 2,5 kg
25	1200 mm	90°-bend	Rp 1/2"	R 1"	85 mm	approx. 2,7 kg
25	1500 mm	90°-bend	Rp 1/2"	R 1"	85 mm	approx. 3,1 kg
25	1800 mm	90°-bend	Rp 1/2"	R 1"	85 mm	approx. 3,4 kg
25	2000 mm	90°-bend	Rp 1/2"	R 1"	85 mm	approx. 3,6 kg

HYDRA® SPRINKLER MOUNTING SYSTEM TYPE 1

HYDRA bracket type 1 with closed sprinkler clamp

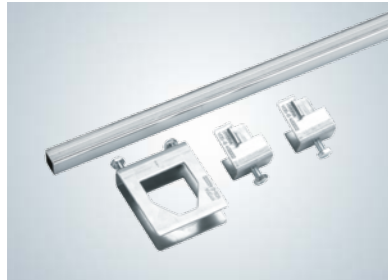

HYDRA bracket type 1 with fold-away sprinkler clamp

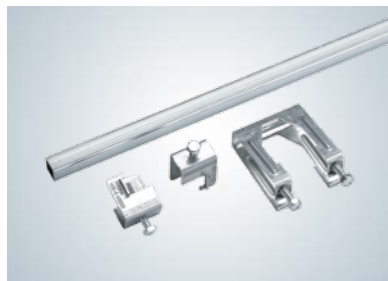

HYDRA mounting system type 1

The mounting clips for the sprinkler bracket type 1 are designed in such a way that the square pipe rests directly on the substructure of the suspended ceiling. This ensures a space-saving installation with a low installation height. The mounting clips can be moved as required and are suitable for round or square contours of ceiling bracket profiles (profile width > 5 mm).

Area of application

- Metal and mineral fibre grid ceiling systems with T-profile rails (main and ancillary supporting beam)
- Metal ceilings with clamping profiles
- Suspension-mounted standard sprinklers
- Mounted directly on the ceiling substructure using suitable mounting clips
- Recommended for confined installations with only small clearance between concrete ceiling and suspended ceiling



INSTALLATION SITUATION TYPE 1

Installation situation 1 Grid ceiling system with T-bars (main supporting beam)

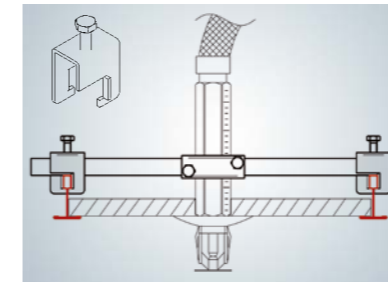

Main supporting profile

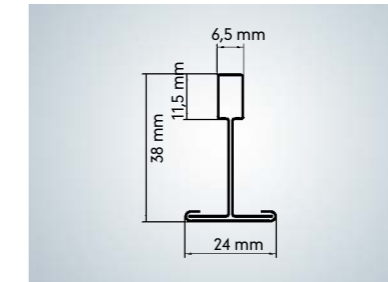

Installation situation 2 Grid ceiling system with T-bars (ancillary supporting beam)

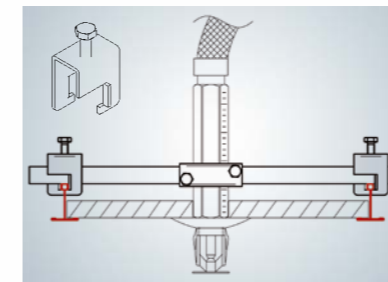

Ancillary supporting profile

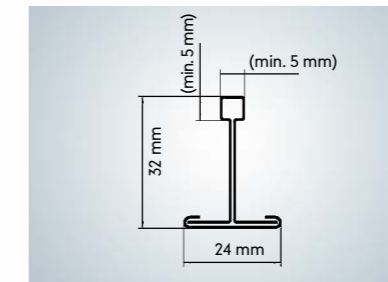

Installation situation 3 Metal ceiling systems with clamping profiles

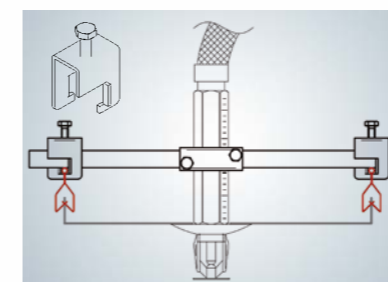

Clamping profile rail

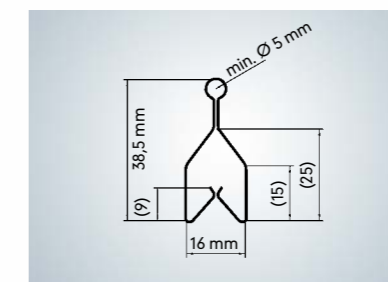

Ceiling systems

Metal and mineral fibre grid ceiling systems with T-profile rails (main and ancillary supporting beam).

- AMF A, C, F and I
- Armstrong
- Dampa Chicago Metallic
- Durlum System II
- Gema-Armstrong lay-in ceilings
- Geipel system EK, EKA and EKP
- Lindner LMD type 4
- Odenwald OWAcoustic S 3, S 14 and S 15
- Odenwald OWAtecta S 33 and S 45
- Richter system 11.1 – 11.4
- Rockfon Pagos
- Suckow & Fischer DP 75, 76, 77, 78, 85, 86, 87, 93
- USG Donn

Metal ceiling systems with clamping profiles

- Dipling KP
- Durlum clip-fitting and clamping profile ceilings
- Gema-Armstrong clamping profile ceilings
- Geipel KK
- Lindner LMD-B and LMD-K
- Suckow & Fischer system rails DP 01, 02, 07, 10, 11, 12

HYDRA® SPRINKLER MOUNTING SYSTEM TYPE 2

HYDRA bracket type 2 with closed sprinkler clamp

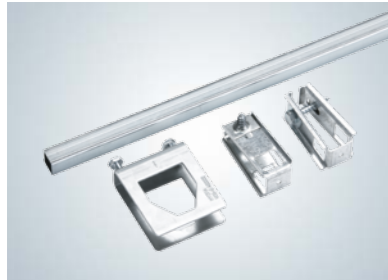

HYDRA bracket type 2 with fold-away sprinkler clamp



HYDRA mounting system type 2

The mounting clips used for the sprinkler bracket type 2 are designed in such a way that the square pipe is mounted approximately 25 mm above the supporting beam of the ceiling substructure and therefore provide sufficient installation height for mounting hidden or recessed sprinklers. This system is also suitable and approved for mounting suspended standard sprinklers.

Area of application

- Metal and mineral fibre grid ceiling systems with T-profile rails (main and ancillary supporting beam)
- Metal ceilings with clamping profiles
- Plasterboard ceiling systems with U-shaped profile rails 60/27
- Suspension-mounted standard sprinklers
- Hidden or recessed sprinklers



INSTALLATION SITUATION TYPE 2

Installation situation 1 Grid ceiling system with T-bars (main supporting beam)

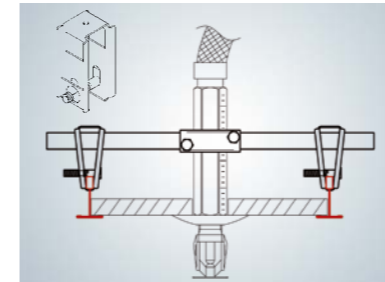

Metal ceilings with clamping profiles

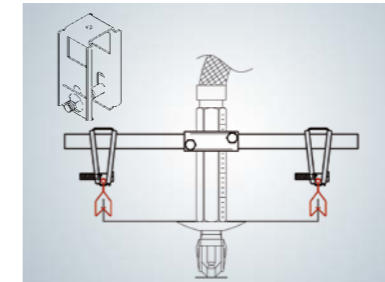

Installation situation 2 Grid ceiling system with T-bars (ancillary supporting beam)

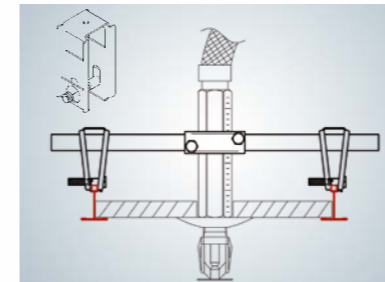

Plasterboard ceiling with U-shaped profile rails

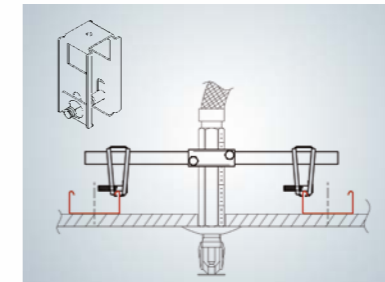

Ceiling systems

Metal and mineral fibre raster ceiling systems with T-profile rails (main and ancillary supporting beam).

- AMF A, C, F and I
- Armstrong
- Dampa Chicago Metallic
- Durlum System II
- Gema-Armstrong lay-in ceilings
- Geipel system EK, EKA and EKP
- Lindner LMD type 4
- Odenwald OWAcoustic S 3, S 14 and S 15
- Odenwald OWAtecta S 33 and S 45
- Richter system 11.1 – 11.4
- Rockfon Pagos
- Suckow & Fischer DP 75, 76, 77, 78, 85, 86, 87, 93
- USG Donn

Metal ceiling systems with clamping profiles

- Dipling KP
- Durlum clip-fitting and lay-in ceilings
- Gema-Armstrong clamping profile ceilings
- Geipel KK
- Lindner LMD-B and LMD-K
- Suckow & Fischer system rails DP 01, 02, 07, 10, 11, 12
- Fural long-panel and metal ceilings

Plasterboard ceiling systems

- Knauf system D112/D113 with profile CD 60/27
- Plasterboard ceiling system using profile CD 60/27
- Richter system 9.2/112 und 9.1/113 plasterboard ceilings
- Lafarge plasterboard ceilings type L51, L53, L55

HYDRA® SPRINKLER MOUNTING SYSTEM TYPE 4

HYDRA bracket type 4 with closed sprinkler clamp



HYDRA mounting system type 4

The sprinkler bracket type 4 is especially suited for floor-ceiling systems. The square pipe (length 2000 mm) is attached directly to the C, Z or U-shaped profile rail running near the wall using type 4 mounting clips.

Area of application

- Floor-ceiling ceiling systems for mounting near walls using C, Z, or U-shaped profile rails
- Modular grid and panel ceiling systems with C, Z or U-shaped profile rails
- Suspension-mounted standard sprinklers
- Also suitable for installing hidden or recessed sprinklers. (The available installation height must be checked.)
- Can be used with acoustic panels without risk of damage

HYDRA bracket type 4 with fold-away sprinkler clamp



Ceiling systems

Ceiling systems for installations near walls using C, Z, or U-shaped profile rails (floor-ceiling systems)

- Lindner LMD
- Knauf D 131
- Suckow & Fischer system 105, 106, 107, 109

Modular grid and panel ceiling systems with C, Z or U-shaped profile rails

- Odenwald OWAacoustic S 1, S 7, S 14
- Odenwald F 30 tectral
- USG Donn

Installation situation

Plasterboard ceiling with square pipe mounted near wall

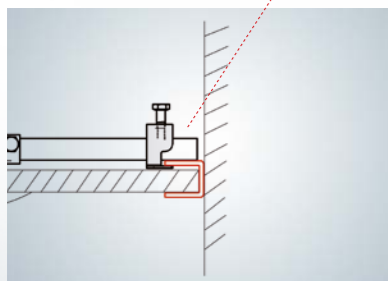
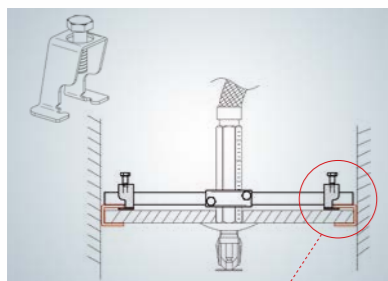

HYDRA® SPRINKLER MOUNTING SYSTEM TYPE 5

HYDRA bracket type 5 with closed sprinkler clamp



HYDRA mounting system type 5

The universal bracket for all ceiling systems with U, C or Z-shaped profile rails.

Area of application

- Plasterboard ceiling systems with U-shaped profile rails 60/27
- Suspension-mounted standard sprinklers
- Steel or stainless steel mounting rails/wide-span mounting profiles
- Modular grid and panel ceiling systems with C, Z or U-shaped profile rails
- Also suitable for installing hidden or recessed sprinklers. (The available installation height must be checked.)
- Mounted directly on the U-shaped ceiling substructure rails. Recommended for confined installations with only a small clearance between concrete ceiling and suspended ceiling.

HYDRA bracket type 5 with fold-away sprinkler clamp

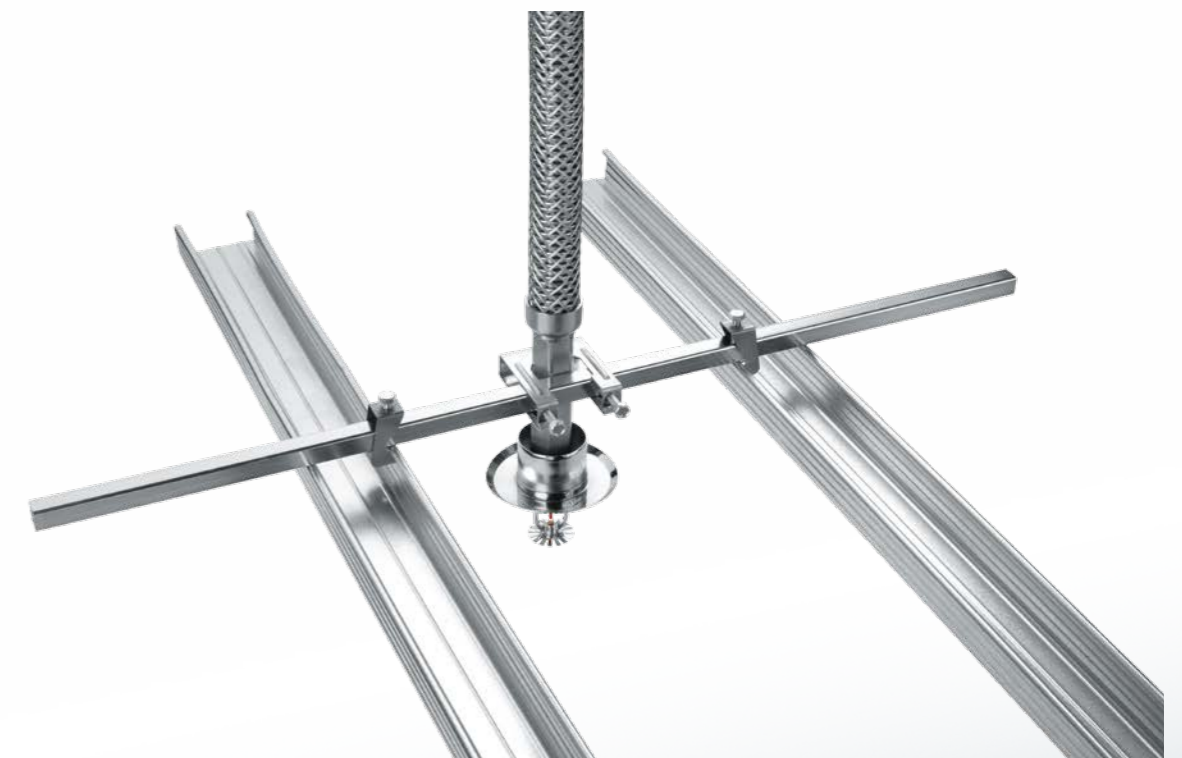

INSTALLATION SITUATION TYPE 5

Modular grid ceiling – installation in C-shaped profile rails

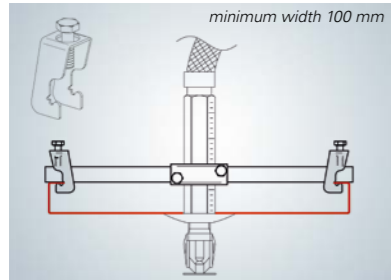

Bandrastrer ceiling – installation between two C-shaped profile rails

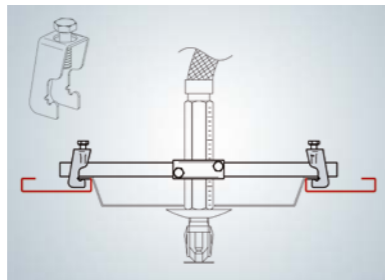

Modular grid ceiling – installation in U-shaped profile rails

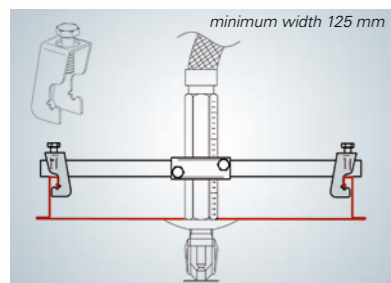

Modular grid ceiling – installation between two U-shaped profile rails

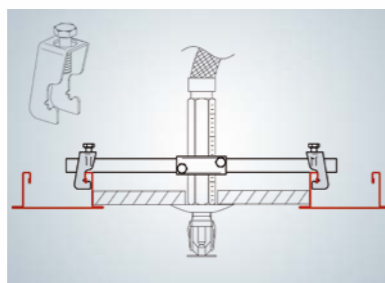

Plasterboard ceiling with U-shaped profile rails (horizontal)

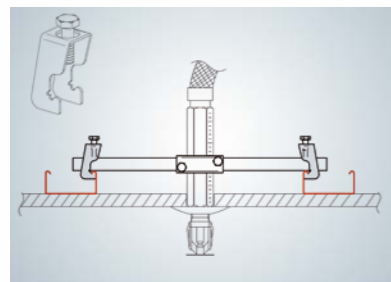

Plasterboard ceiling with mounting clips

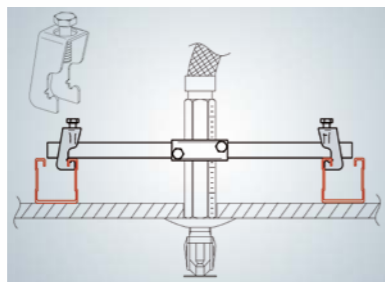

Plasterboard ceiling with U-shaped profile rails (vertical)

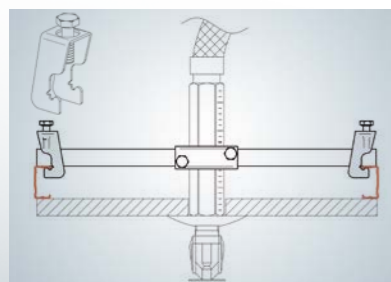

Grid ceiling system with Z-shaped profile rails

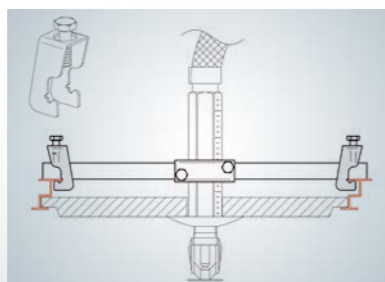

Ceiling systems

Plasterboard ceiling systems

- Knauf system D112/D113 with profile CD 60/27
- Knauf ceiling system D 131
- Plasterboard ceiling system using profile CD 60/27
- Richter system 9.2/112 und 9.1/113 plasterboard ceilings
- Lafarge plasterboard ceilings type L51, L53, L55

Mounting rails/wide-span mounting profiles

- Hilti MQ 41
- Suckow & Fischer system rails DP 96, 98, 99
- Richter system STYRAG-WSP wide-span mounting profile

Modular grid and panel ceiling systems with C, Z or U-shaped profile rails (recommended minimum width for mounting on C or U-shaped profile rails 100 mm)

- Durlum S5 / S6, C/100
- Knauf D 131
- Lindner LMD
- Odenwald OWAacoustic S 9, S 18
- Odenwald OWAteca S 39, S 55
- Richter system 6.1, 6.2, 12.1, 12.2
- Rockfon modular grid system
- Suckow & Fischer system rails, production series DP, PB, UPB, WBP, K450/100
- USG Donn

HYDRA® SPRINKLER MOUNTING SYSTEM TYPE 6

HYDRA bracket type 6 with closed sprinkler clamp



HYDRA mounting system type 6

The sprinkler mount type 6 is suitable for mounting on level surfaces, e. g. with aluminium hollow clamping profiles. It can be mounted in any position using conventional sheet metal screws. The mounting clips are delivered with the units open and can be easily pressed together by hand during assembly. The square pipe tightens with the mounting clips and is axially fixed.

Area of application

- For attaching using sheet metal screws on level surfaces

HYDRA bracket type 6 with fold-away sprinkler clamp



Installation situation Aluminium hollow clamping profile

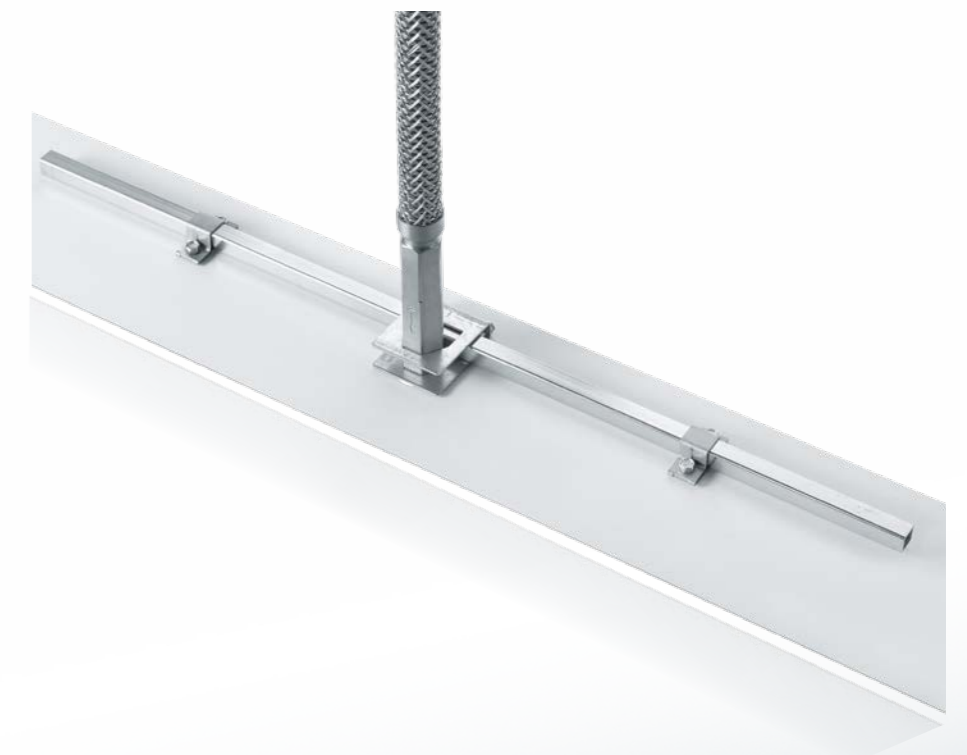
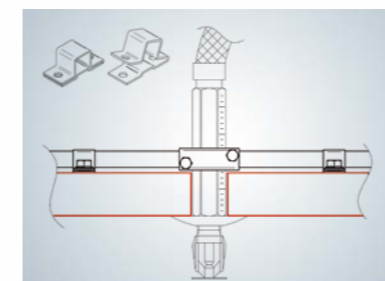

HYDRA® SPRINKLER MOUNTING SYSTEM TYPE 7

Mounting system type 7

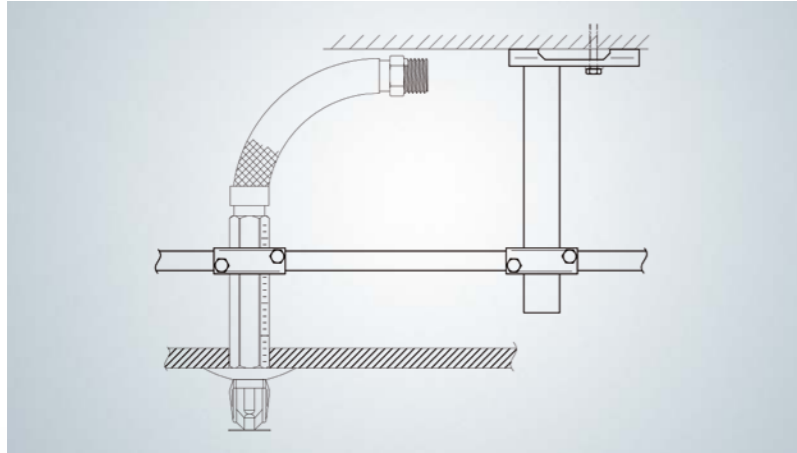

The sprinkler hose is attached using this bracket, regardless of the construction and geometry of the suspended intermediate ceiling. The base supporting beam is anchored directly on the concrete ceiling. The sprinkler can be positioned as required in a radius of 600 mm around the mounting position of the base supporting beam. The side lateral offset can be implemented using a square pipe, which is securely screwed onto the pipe of the base supporting beam using a sprinkler clamp.

Area of application

- For mounting directly on concrete ceilings
- Base supporting beam available in lengths of 250, 500, 750, 1000 mm
- Square pipe permitted only for 700 mm



HYDRA® SPRINKLER BRACKET L TYPE 11

Installation situation Aluminium meshed metal baffle ceiling system

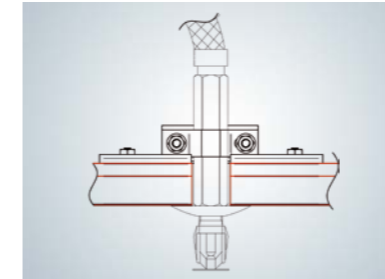

Department store ceiling system

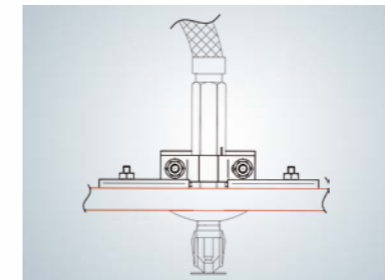

HYDRA sprinkler bracket L type 11

Area of application

- For mounting using t-bolts/nuts in the profile rails of department store ceilings and aluminium profile rails of meshed metal baffle ceilings or clean room ceilings
- Not for assembly in cross-profiles in clean room filter ceilings

Ceiling systems

- Suckow & Fischer 1700/DP88 (department store ceilings)
- M & W Zander
- Daldrop & Dr. Huber
- Aluminium meshed metal baffle ceiling Schmid GmbH manufacturer
- Lindner aluminium meshed metal baffle ceilings

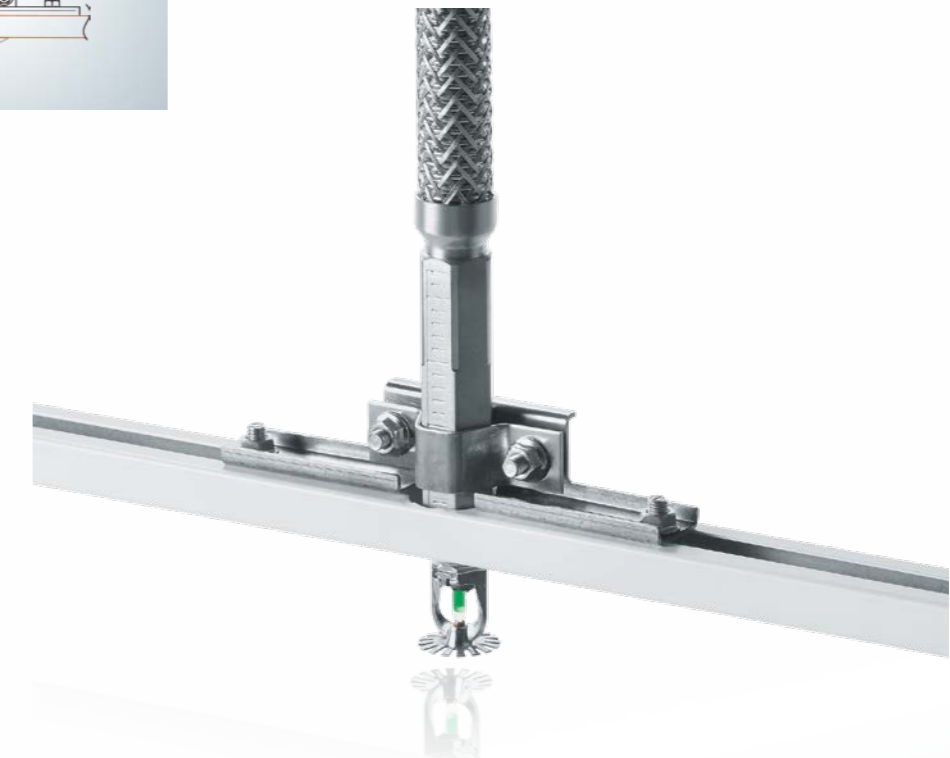

HYDRA® SPRINKLER BRACKET L TYPE 12

Modular grid ceiling system U-shaped



Installation situation Modular grid ceiling system U-shaped

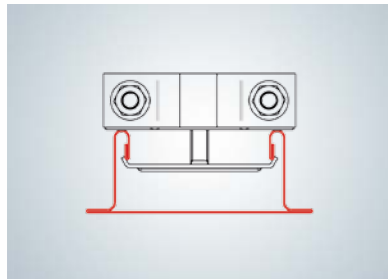

HYDRA sprinkler bracket L type 12

Area of application

- For force-fit mounting inside the narrow U-shaped profile rails of modular grid and panel ceiling systems

Ceiling systems

- Durlum S5/S6, C/100, dur F30
- Lindner LMD
- Odenwald OWAtecta S 39, S 55
- Richter systems 6.1, 6.2, 12.1, 12.2
- Suckow & Fischer system rails, production series PB, K450/100
- Donn DP modular grid



HYDRA® SPRINKLER BRACKET L TYPE 13

Modular grid ceiling system (C-shaped profile rail)



Installation situation modular grid ceiling system (C-shaped profile rail)

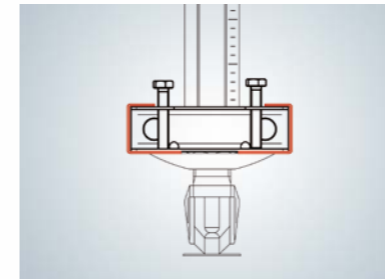

Installation situation Modular grid ceiling system (U-shaped profile rail)

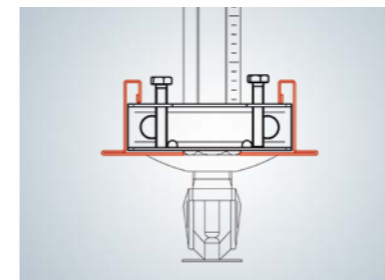

HYDRA sprinkler bracket L type 13

Area of application

- For form- and force-fit mounting inside the C or U-shaped profile rails of modular grid and panel ceiling systems (minimum width 100 mm)
- Available for C and U-shaped profiles 100/125/150
- Not for use with two-piece rosettes

Ceiling systems

- Durlum S5 / S6, C/100
- Lindner LMD
- Odenwald OWAacoustic S 18
- Odenwald OWAtecta S 39, S 55
- Richter system 6.1, 6.2, 12.1, 12.2
- Suckow & Fischer system rails, production series DP, PB, UPB, WBP, K450/100
- USG Donn

Profile widths

C-shaped profile e.g. PB	U-shaped profiles e.g. UPB
mm	mm
100	125
125	150
150	-



HYDRA® SPRINKLER BRACKET L TYPE 10/15

Installation situation Modular grid ceiling system (C-shaped profile rail)

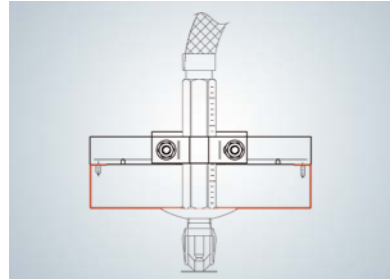

HYDRA sprinkler bracket L type 10/15

Area of application

- For mounting directly on top of C-shaped profile rails of bandrastrer and panel ceiling systems using sheet metal screws
- Available for C-shaped profiles 75, 100, 125, 150, 200 mm
- For mounting on all suitable surfaces using sheet metal screws

Ceiling systems

- Durlum S5 / S6, C/100
- Lindner LMD
- Odenwald OWAtecta S 39, S 55
- Richter system 6.1, 6.2, 12.1, 12.2
- Suckow & Fischer system rails, production series PB, K450/100



HYDRA® SPRINKLER BRACKETS

for clean room filter ceiling systems

Hoses for clean room filter ceiling systems



Clean room filter ceiling systems

Metal hose

Type RS 331L12, stainless steel 1.4404 or 1.4541, DN 25, braiding and end bushing made of stainless steel 1.4301, welded version

Nominal length

NL 1000 / 1200 / 1500 / 2000, other nominal lengths on request

Sprinkler connection

- 200 mm stainless steel sprinkler sleeve 1.4301 (AISI 304) with internal thread Rp 1/2" or NPT 1/2"
- Ceiling feedthrough with fixed mounting plate
- Installation in profile rails of filter ceilings
- Variable distance measure to sprinkler outlet
- For assembly in cross-profiles in clean room filter ceilings

Connection to water supply line

- Stainless steel thread connection for mounting to water supply line
- Designed as conical seal connection or fixed hexagonal nipple with connection thread R/RP 1"
- All components stamped with VDS approval number and FM logo

Ceiling systems

- M+W Zander
- Daldrop & Dr. Huber

Installation

Mounting is carried out via faceplate and t-bolts (not included in delivery scope) to aluminium profiles of suspended filter ceilings.

Installation situation

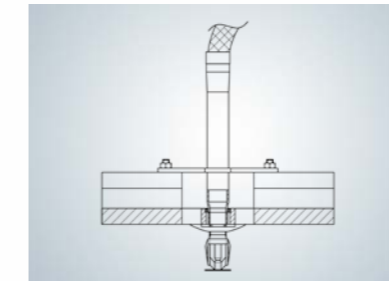

Our Approvals



HYDRA® SPRINKLER BRACKETS

For modular grid ceiling and sheet metal panel systems



Sheet metal panel systems

Area of application

The provided sheet metal adapters are simply hooked into the profile of the ceiling panel and firmly screwed to the mounting bracket using wing nuts.

Ceiling systems

Nagelstutz & Eichler NE 1216 & 1241

DESIGN AND PLANNING

Bending radii/minimum distances

Lateral view

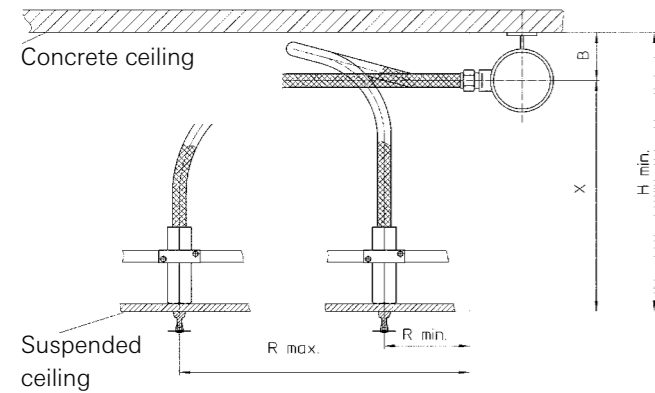

Top view

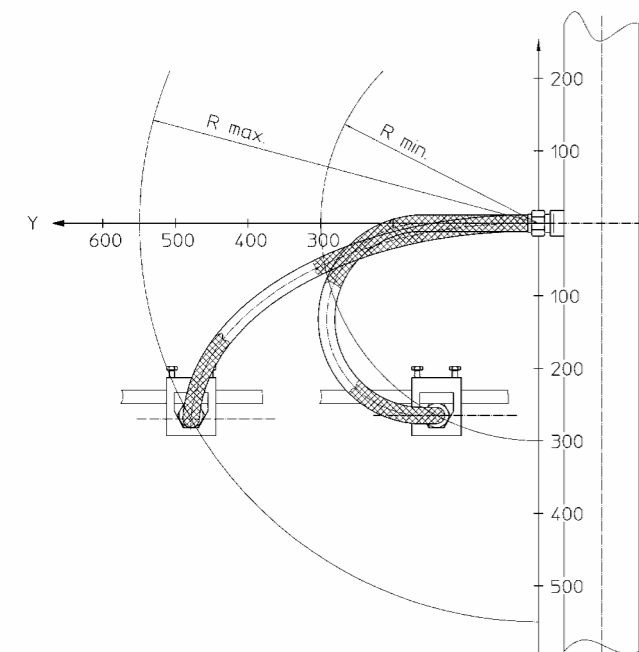

When designing and planning, it must be ensured that the minimum permissible bending radii of the sprinkler hoses, e.g. when bypassing other technical assemblies, are not too small. A minimum clearance H (min.) must be maintained between the concrete ceiling and the suspended ceiling. This measurement depends on the nominal width of the hoses used (see installation sketch). In confined installations, a special version with a 90° bend is available. The minimum distance (H) is then only 140 mm (DN 20) or 150 mm (DN 25).

The sprinkler hose outlets should be located on the side of the supply line, parallel to the concrete ceiling (see installation sketch). A distance (B) of more than 80 mm is recommended between the concrete ceiling and axis of the vertical sprinkler hose outlet. In confined installations, the hose should be installed in the form of a loop (see installation sketch). However, the distance between concrete ceiling and axis of vertical sprinkler hose outlet should not be less than a value B (min.) of 50 mm.

When planning the installation points for the sprinklers, take into account the installation dimensions shown in the table p. 27. For the hydraulic calculation of the pipe system please take equivalent pipe lengths acc. to table p. 28-29.

No-nominal width	Minimum bending radius with single bending	Minimum bending radius for frequent movements
DN 20	70 mm	170 mm
DN 25	85 mm	190 mm*

* Relevant minimum bending radius as per FM guidelines

No-nominal width	Minimum distance (H)	
	Straight design	90° bend
DN 20	240 mm	140 mm
DN 25	270 mm	150 mm

DESIGN AND PLANNING

Installation dimension DN 20/DN25

NL	x		DN 20				DN 25			
	mm	inch	R min.		R max.		R min.		R max.	
	mm	inch	mm	inch	mm	inch	mm	inch	mm	inch
800 31.5"	< 200	< 7.9"	not recommended				not recommended			
	300	11.8"	300	11.8"	500	19.7"	300	11.8"	500	19.7"
	400	15.7"	200	7.9"	450	17.7"	200	7.9"	450	17.7"
	500	19.7"	100	3.9"	400	15.7"	100	3.9"	400	15.7"
1000 39.4"	< 200	< 7.9"	not recommended				not recommended			
	300	11.8"	300	11.8"	700	27.6"	300	11.8"	700	27.6"
	400	15.7"	200	7.9"	650	25.6"	300	11.8"	700	27.6"
	500	19.7"	100	3.9"	600	23.6"	200	7.9"	650	25.6"
	600	23.6"	0	0	550	21.7"	100	3.9"	600	23.6"
1200 47.2"	< 300	11.8"	0	0	1000	39.4"	0	0	1000	39.4"
	400	15.7"	0	0	900	35.4"	0	0	900	35.4"
	500	19.7"	0	0	850	33.5"	0	0	850	33.5"
	600	23.6"	0	0	800	31.5"	0	0	800	31.5"
	700	27.6"	0	0	700	27.6"	0	0	700	27.6"
	800	31.5"	0	0	650	25.6"	0	0	600	23.6"
	900	35.4"	0	0	600	23.6"	0	0	500	19.7"
1500 59.0"	< 300	11.8"	0	0	1200	47.2"	0	0	1200	47.2"
	400	15.7"	0	0	1150	45.3"	0	0	1150	45.3"
	500	19.7"	0	0	1150	45.3"	0	0	1150	45.3"
	600	23.6"	0	0	1100	43.3"	0	0	1100	43.3"
	700	27.6"	0	0	1000	39.4"	0	0	1000	39.4"
	800	31.5"	0	0	1000	39.4"	0	0	1000	39.4"
	900	35.4"	0	0	900	35.4"	0	0	900	35.4"
	1000	39.4"	0	0	900	35.4"	0	0	900	35.4"
1800 70.9"	< 300	< 11.8"	0	0	1500	59.1"	0	0	1500	59.1"
	400	15.7"	0	0	1400	55.1"	0	0	1400	55.1"
	500	19.7"	0	0	1400	55.1"	0	0	1400	55.1"
	600	23.6"	0	0	1350	53.1"	0	0	1350	53.1"
	700	27.6"	0	0	1350	53.1"	0	0	1350	53.1"
	800	31.5"	0	0	1300	51.2"	0	0	1300	51.2"
	900	35.4"	0	0	1250	49.2"	0	0	1250	49.2"
	1000	39.4"	0	0	1200	47.2"	0	0	1200	47.2"
2000	< 300	11.8"	0	0	1750	68.9"	0	0	1750	68.9"
	400	15.7"	0	0	1700	66.9"	0	0	1700	66.9"
	500	19.7"	0	0	1700	66.9"	0	0	1700	66.9"
	600	23.6"	0	0	1650	65"	0	0	1650	65"
	700	27.6"	0	0	1650	65"	0	0	1650	65"
	800	31.5"	0	0	1600	63"	0	0	1600	63"
	900	35.4"	0	0	1550	61"	0	0	1550	61"
	1000	39.4"	0	0	1500	59.1"	0	0	1500	59.1"

DESIGN AND PLANNING

Equivalent pipe lengths



DN 20/25 – Equivalent pipe lengths according to VdS specifications

Nominal length	DN 20		Nominal length	DN 25	
	Δ p	L (äq.)		Δ p	L (äq.)
500 mm	0,8 bar	5 m	500 mm	0,5 bar	4 m
1000 mm	0,9 bar	8 m	1000 mm	0,5 bar	8 m
1200 mm	1,0 bar	12 m	1200 mm	0,6 bar	11 m
1500 mm	1,3 bar	12 m	1500 mm	0,8 bar	11 m
2000 mm	1,7 bar	14 m	2000 mm	1,0 bar	12 m

The VdS values are based on measurements taken with a flow velocity of 5 m/sec.



DN 25 – Equivalent pipe lengths according to FM 1637

Nominal length of sprinkler hose	Pipe thread x sprinkler outlet	Sprinkler hose design	Equivalent pipe lengths (FM measured value)
800 mm	R1" x Rp 1/2"	straight	6,8 m
1000 mm	R1" x Rp 1/2"	straight	9,3 m
1200 mm	R1" x Rp 1/2"	straight	10,0 m
1500 mm	R1" x Rp 1/2"	straight	12,2 m
1800 mm	R1" x Rp 1/2"	straight	13,8 m
800 mm	R1" x Rp 3/4"	straight	4,6 m
1000 mm	R1" x Rp 3/4"	straight	6,8 m
1200 mm	R1" x Rp 3/4"	straight	8,1 m
1500 mm	R1" x Rp 3/4"	straight	10,1 m
1800 mm	R1" x Rp 3/4"	straight	11,7 m
800 mm	R1" x Rp 1/2"	90°-bend	12,5 m
1000 mm	R1" x Rp 1/2"	90°-bend	13,6 m
1200 mm	R1" x Rp 1/2"	90°-bend	17,2 m
1500 mm	R1" x Rp 1/2"	90°-bend	17,9 m
1800 mm	R1" x Rp 1/2"	90°-bend	21,4 m

DESIGN AND PLANNING

Equivalent pipe lengths



DN 20 – Equivalent pipe lengths according to FM 1637

Nominal length of sprinkler hose	Pipe thread x sprinkler outlet	Sprinkler hose design	Equivalent pipe lengths (FM measured value)
600 mm	R 3/4" x Rp 1/2"	straight	11,6 m
700 mm	R 3/4" x Rp 1/2"	straight	14,6 m
800 mm	R 3/4" x Rp 1/2"	straight	16,1 m
1000 mm	R 3/4" x Rp 1/2"	straight	21,9 m
1200 mm	R 3/4" x Rp 1/2"	straight	25,7 m
1500 mm	R 3/4" x Rp 1/2"	straight	31,9 m
1800 mm	R 3/4" x Rp 1/2"	straight	38,3 m
600 mm	R1" x Rp 1/2"	straight	9,9 m
700 mm	R1" x Rp 1/2"	straight	13,0 m
800 mm	R1" x Rp 1/2"	straight	14,6 m
1000 mm	R1" x Rp 1/2"	straight	20,3 m
1200 mm	R1" x Rp 1/2"	straight	24,1 m
1500 mm	R1" x Rp 1/2"	straight	30,3 m
1800 mm	R1" x Rp 1/2"	straight	36,7 m
600 mm	R 3/4" x Rp 1/2"	90°-bend	21,6 m
700 mm	R 3/4" x Rp 1/2"	90°-bend	22,6 m
800 mm	R 3/4" x Rp 1/2"	90°-bend	27,0 m
1000 mm	R 3/4" x Rp 1/2"	90°-bend	28,3 m
1200 mm	R 3/4" x Rp 1/2"	90°-bend	32,1 m
1500 mm	R 3/4" x Rp 1/2"	90°-bend	34,9 m
1800 mm	R 3/4" x Rp 1/2"	90°-bend	40,7 m
600 mm	R1" x Rp 1/2"	90°-bend	20,0 m
700 mm	R1" x Rp 1/2"	90°-bend	21,0 m
800 mm	R1" x Rp 1/2"	90°-bend	25,5 m
1000 mm	R1" x Rp 1/2"	90°-bend	26,7 m
1200 mm	R1" x Rp 1/2"	90°-bend	30,5 m
1500 mm	R1" x Rp 1/2"	90°-bend	33,3 m
1800 mm	R1" x Rp 1/2"	90°-bend	39,7 m

HYDRA® STAINLESS STEEL HOSES

Assembled to suit the application, with certification
HYDRA® hoses: increased safety for fire protection.



Hundreds of thousands of sprinkler hoses have been used over many years, and are often used as "problem solvers" in sprinkler systems with movable equipment parts. The VdS-approved production series type RS 331L12 and type RS 341L12 range from DN 20 to DN 100 and can be supplied according to customer requirements with a variety of different fittings.

In addition to obtaining VdS approval, they have also been certified by the British Loss Prevention Certification Board (LPCB). The LPCB-approved production series type RS 331/330L12 and type RS 321L12 range from DN 16 to DN 100. They can also be mounted with different fittings according to customer requirements.

In the area of passenger shipping, all reputable shipping classification organisations have provided their approval. Specialised solutions for suspended sheet metal panel ceilings are also available for this segment.

Specially designed sprinkler hoses can also be used in high pressure atomised spray fire water extinguishing facilities up to an operating pressure of 300 bar depending on the nominal width and the design. They are used in a host of "mobile systems, e.g. fire protection system in railway vehicles or passenger ships.

HYDRA® STAINLESS STEEL HOSES

Stock list for sprinkler systems – threaded connection

Type LA 230

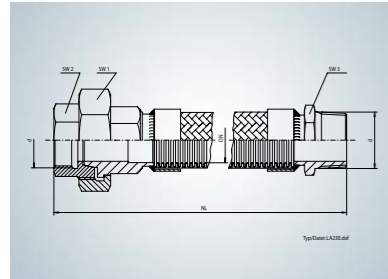

Stainless steel hoses with threaded connections

Hose line

Type RS 331L12 with single braiding. Conical seal screw coupling with internal thread at one end, hexagonal nipple with outer thread at other end, stamped with VdS approval number for use in stationary water extinguishing systems.

Dimensions

- DN 20 – DN 50
- NL 500/800/1000/1500, further nominal lengths on request

Material

- Hose: stainless steel, 1.4404 (AISI 316 L) or 1.4541 (AISI 321)
- Braiding: stainless steel, 1.4301 (AISI 304)
- End sleeve: stainless steel, 1.4301 (AISI 304)
- Threaded connections: malleable cast iron/steel/stainless steel, welded

Delivery

From stock (prior sale reserved).

Other nominal lengths available on request.

Our Approvals



HYDRA® STAINLESS STEEL HOSES

Stock list for sprinkler systems – flanges

Type LA 201

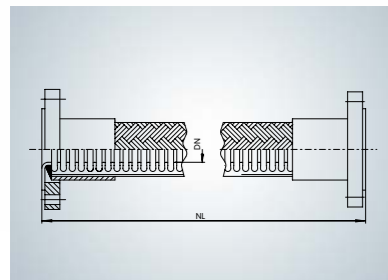

Stainless steel hoses with loose flanges

Hose line

Type RS 331L12 (DN 20 - DN 65), Type RS 341L12 (DN 80 - DN 100) with single braiding. Loose flange connections CA 82E at both ends, stamped with VdS approval number for use in stationary water extinguishing systems.

Dimensions

- DN 20 – DN 100
- NL 500/1000/1500, further nominal lengths on request

Material

- Hose: stainless steel, 1.4404 (AISI 316L) or 1.4541 (AISI 321)
- Braiding: stainless steel, 1.4301 (AISI 304)
- End sleeve: stainless steel, 1.4301 (AISI 304)
- Welding rim: stainless steel, welded
- Loose flanges: S235JR (1.0038), galvanized

Delivery

From stock (prior sale reserved).

Other nominal lengths available on request.

Our Approvals



HYDRA® STAINLESS STEEL HOSES

Manufacturing programme

Type RS 3... with braiding

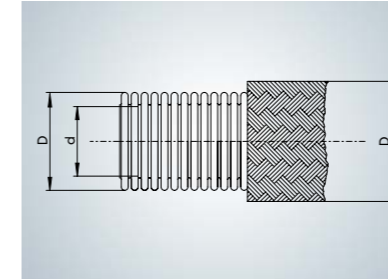

Stainless steel hoses, medium Version

Hose line

Type RS 331/341L12 with single braiding
Type RS 339L92 with light braiding (DN 20, DN 25)

Material

- Hose: stainless steel, 1.4571 (AISI 316 Ti), 1.4541 (AISI 321) or 1.4404 (AISI 316 L);
- Braiding: stainless steel, 1.4301 (AISI 304)
- End sleeve: stainless steel, 1.4301 (AISI 304)

Special applications

For applications with movable equipment parts, e.g. high racking system with movable storage racks, we recommend customised technical designs with our technology, adapted to the loading conditions that can be expected in operating conditions.

Our Approvals



Nominal diameter	Type	Inside diameter	Outside diameter	Minimum bending radius One-time movement	Nominal bending radius frequent movement	Operating pressure (acc. to VdS instructions)	Weight Approx.	Produced length max.
DN	-	d	D	r _{min}	r _n	PN	-	-
-	-	mm	mm	mm	mm	-	kg/m	m
Medium version, standard corrugation								
20	RS 331L12	20,2	28,3	70	170	12	0,49	100
25	RS 331L12	25,5	34,2	85	190	12	0,79	100
32	RS 331L12	34,2	43,0	105	260	12	0,96	100
40	RS 331L12	40,1	52,0	130	300	12	1,46	30
50	RS 331L12	50,4	62,6	160	320	12	1,67	30
65	RS 331L12	65,3	81,2	200	460	12	2,88	20
80	RS 341L12	80,2	98,0	240	660	12	4,08	20
100	RS 341L12	100,0	119,4	290	750	12	4,54	20
Medium version, standard corrugation, light braiding								
20	RS 339L92	20,2	28,3	70	170	16	0,34	*
25	RS 339L92	25,5	33,4	85	190	16	0,41	*

* VDS approval limits max. length to NL 2500 mm.

When ordering, please specify: type, nominal diameter (DN), nominal length (NL)

HYDRA® STAINLESS STEEL HOSES

For high-pressure applications

Type RS 531

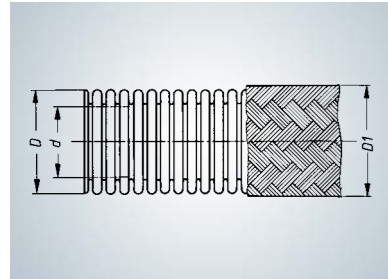

Stainless steel hoses for higher operating pressures

- Type RS 531 S12 with single braiding
- Type RS 531 S22 with double braiding
- Corrugated hose, standard corrugation, increased wall thickness

Material

- Hose: stainless steel, 1.4571 (AISI 316 Ti), 1.4541 (AISI 321) or 1.4404 (AISI 316L)
- Braiding: stainless steel, 1.4301 (AISI 304)
- End sleeve: stainless steel, 1.4301 (AISI 304)
- Other materials are available on request

Approval

Inspection costs will be invoiced as incurred per order

Connection fittings

(see page 36)

Our Approvals



Nominal diameter	Type	Inside diameter	Outside diameter	Minimum bending radius One-time movement	Permissible static operating pressure at 20 °C SF 4	Example: maximum permissible operating pressure with DNV-GL certification	Weight approx.
DN	-	d	D	r _{min}	P _{zul}	-	-
-	-	mm	mm	mm	bar	bar	kg/m
6	RS531S12	6,2	11,6	25	200	260	0,23
	RS531S22		13,0	40	250	300	0,33
8	RS531S12	8,0	14,5	32	200	190	0,35
	RS531S22		16,1	50	250	300	0,49
10	RS531S12	10,0	17,5	38	150	170	0,48
	RS531S22		19,1	60	225	250	0,66
12	RS531S12	12,1	20,3	45	100	125	0,62
	RS531S22		21,9	70	200	250	0,82
16	RS531S12	16,1	25,8	58	150	145	0,92
	RS531S22		27,8	90	200	225	1,29



HYDRA® STAINLESS STEEL HOSES

For high-pressure applications

Type RS 430

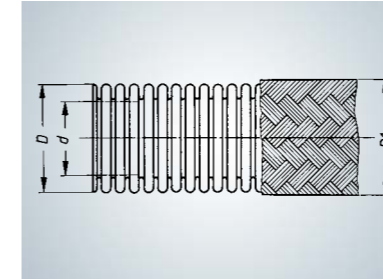

Stainless steel hoses for higher operating pressures

- RS 430 S12 with single braiding
- RS 430 S22 with double braiding
- RS 430 S42 with single braiding, knurled
- RS 430 S52 mit double braiding, knurled
- RS 430 S92 with double special braiding
- Corrugated hose, standard corrugation, increased wall thickness

Material

- Hose: stainless steel, 1.4571 (AISI 316 Ti), 1.4541 (AISI 321) or 1.4404 (AISI 316L)
- Braiding: stainless steel, 1.4301 (AISI 304)
- End sleeve: stainless steel, 1.4301 (AISI 304)

Approval

Inspection costs will be invoiced as incurred per order

Connection fittings

(see page 36)

Our Approvals



Nominal diameter	Type	Inside diameter	Outside diameter	Minimum bending radius One-time movement	Permissible static operating pressure at 20 °C SF 4	Example: maximum permissible operating pressure with DNV-GL certification	Weight approx.
DN	-	d	D	r _{min}	P _{zul}	-	-
-	-	mm	mm	mm	bar	bar	kg/m
20	RS430S12	20,2	31,2	70	90	100	0,93
	RS430S22		33,2		125	125	1,31
25	RS430S12	25,2	36,2	85	65	63	1,07
	RS430S22		38,2		100	100	1,49
32	RS430S12	33,7	45,0	105	65	32	1,41
	RS430S22		47,2		80	80	2,05
40	RS430S12	40,0	57,3	130	40	40	2,09
	RS430S22		59,5		65	63	2,81
50	RS430S12	50,0	68,2	160	50	50	2,91
	RS430S22		71,3		80	63	4,15
65	RS430S12	65,0	84,2	200	35	32	3,46
	RS430S22		87,3		50	50	4,89
80	RS430S12	79,8	101,5	240	25	32	4,65
	RS430S22		104,6		50	50	6,46
100	RS430S12	99,8	121,0	290	30	25	5,97
	RS430S22		124,1		40	40	8,25
125	RS430S12	125,6	149,2	350	16	20	7,80
	RS430S22		152,4		30	32	10,30
150	RS430S92	151,9	184,6	400	16	16	11,37
200	RS430S92	202,2	239,7	520	16	16	16,82
250	RS430S52	248,4	295,2	620	12	10	22,96
300	RS430S52	298,6	346,8	1000	6	6	28,83

CONNECTION FITTINGS

Manufacturing program

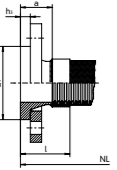
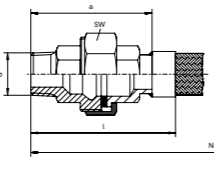
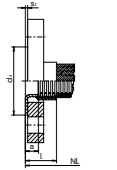
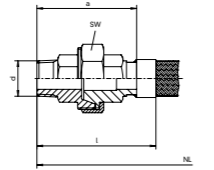
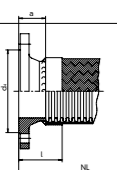
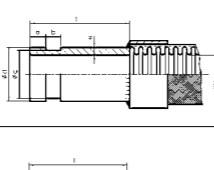
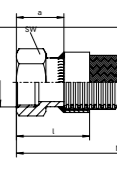
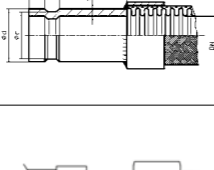
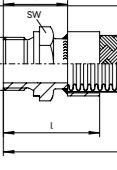
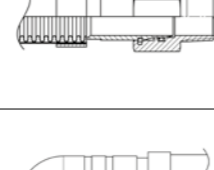
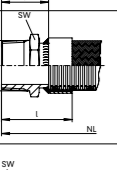
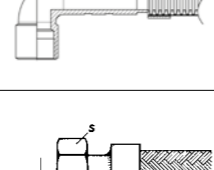
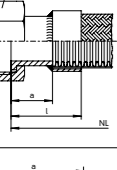
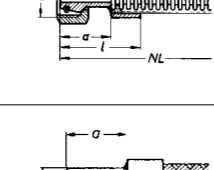
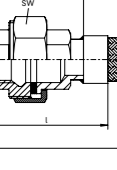
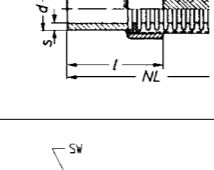
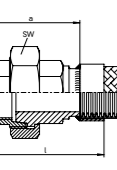
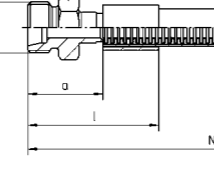
Connection	Description	Type	Connection	Description	Type
	Swivel flange connection Welding neck with loose flange	Type AB DN 20 - DN 100		Flat seal screw coupling External thread to DIN EN 10226-1 (ISO 7/1)	Type RE DN 20 - DN 50
	Swivel flange connection Welding rim with loose flange	Type CA DN 20 - DN 100		Conical seal screw coupling External thread to DIN EN 10226-1 (ISO 7/1)	Type RF DN 20 - DN 50
	Fixed flange connection Welding neck flange	Type GB DN 20 - DN 100		Victaulic system, Grooved pipe ends	DN 20 - DN 100
	Hexagonal threaded socket fixed Pipe thread to DIN EN 10226-1 (ISO 7/1)	Type LA DN 20 - DN 50		Grinell system, Grooved pipe ends	DN 20 - DN 100
	Hexagonal threaded nipple fixed External thread to ISO 228/1	Type MA DN 20 - DN 100		Swivel connection External thread to DIN 10226-1	DN 20 - DN 25 External thread
	Hexagonal threaded nipple fixed Pipe thread to DIN EN 10226-1 (ISO 7/1)	Type MH DN 20 - DN 80		External thread connection with 90° short elbow Internal thread to DIN 10226-1 3/4 or 1"	DN 20 - DN 25 Internal thread
	Threaded connection, swivel, collar pipe flat sealing with union nut, thread ISO 228/1	Type NA DN 20 - DN 50		Threaded connection, swivel 24° conical nipple with O-ring*, union nut DIN ISO 12151-2	Type NN12R, Type NN22R DN 6 - DN 40 Internal thread
	Flat seal screw coupling Internal thread to DIN EN 10226-1 (ISO 7/1)	Type QA DN 20 - DN 50		Pipe connection Precision nipple for cutting ring screw connection DIN 3861 (L series)	Typ UD12Q, Typ UD22Q
	Conical seal screw coupling Internal thread to DIN EN 10226-1 (ISO 7/1)	Type QB DN 20 - DN 50		24° threaded pin for screwed pipe fittings with metric external thread to DIN ISO 12151-2 or Whitworth pipe thread to DIN 3852-2	DN 6 - DN 40 External thread

HYDRA[®] AXIAL EXPANSION JOINTS

With VdS acceptance

DVGW approval to DIN 30681

Our Approvals



HYDRA® AXIAL EXPANSION JOINTS

With VdS acceptance
DVGW approval to DIN 30681

Type AFF DN 25 – DN 100

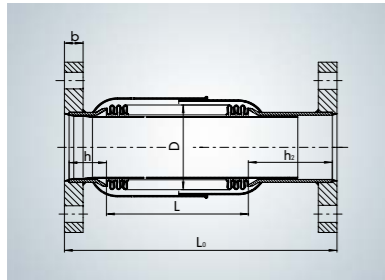

Type AFF, Type ABZ

Pipes can stretch or shorten when subjected to changes in temperature. These changes in lengths can result in significant stress on fixed installed piping systems and attachment and connection points. HYDRA expansion joints for building services are available in a wide range of designs. Axial expansion joints are available in VdS-approved designs with guidance and protective piping for use in stationary water extinguishing systems. Expansion joints of the production series AFZ and ABZ are designed for operating temperatures up to 300 °C and a nominal pressure of 16 bar.

Production series AFF

DN 25 – DN 100

- With inner sleeve and external external protective pipe
- Fixed flange
- Pre-stressed

Material/connections

- Multi-ply bellow made of stainless steel 1.4571
- Inner sleeve of stainless steel 1.4571
- External protective pipe of stainless steel 1.4541/1.4571
- Flange of steel S235JR (1.0038)

Production series ABZ

DN 125 – DN 300

- With external protective pipe
- Rotating loose flange

Material/connections

- Multi-ply bellow made of stainless steel 1.4541
- Protective guide tubes made of stainless steel 1.4541
- Flange steel steel S235JR (1.0038) dipped varnish

Operating temperature

up to 300 °C

Nominal pressure

16 bar

Text for tenders

HYDRA axial expansion joints made of stainless steel 1.4571
Flange steel S235JR (1.0038)
in VdS-approved design
for use in stationary water extinguishing systems
Type AFF/ABZ _____ PN 16
DN _____
Overall length _____
Axial movement absorption _____
DN _____ NL _____

Type ABZ DN 125 – DN 300

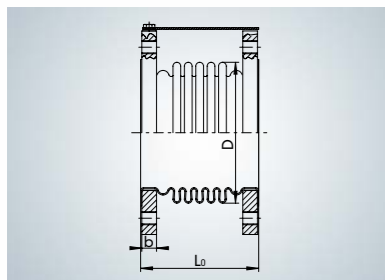

Our Approvals

DIN EN ISO 9001 / EN 29001



HYDRA® AXIAL EXPANSION JOINTS

With VdS acceptance
DVGW approval to DIN 30681

Type AFF, Type ABZ

Nominal diameter	Pressure level	Movement absorption		Type AFF/ABZ	Overall length when loose	Weight Approx.	Flange			Bellows			Axial adjusting force rate	Ident. Nr.
		axial nominal	lateral				Hole pattern as per DIN EN 1092-1	Flange diameter	Flange thickness	Outside diameter	Corrugated length	Effective cross-section		
DN	PN	-	-	-	L ₀	G	-	d	b	D	L	A	C _d	-
-	-	-	-	-	mm	kg	PN	mm	mm	mm	mm	cm ²	N/mm	-
25	16	±20 = 40 ±32 = 64	0	16.0025.040.2 16.0025.064.2	230 312	3,0 3,2	10/16 10/16		16	43 43	110 160	10,6 10,6	40 27	331463 331464
32	16	±20 = 40 ±32 = 64	0	16.0032.040.2 16.0032.064.2	252 338	4,4 4,9	10/16 10/16		16	56 56	122 176	18,2 18,2	39 27	331465 331466
40	16	±18 = 36 ±32 = 64	0	16.0040.036.2 16.0040.064.2	248 418	5,1 6,1	10/16 10/16		16	60 60	118 238	21,3 21,3	55 42	331467 331468
50	16	±20 = 40 ±32 = 64	0	16.0050.040.2 16.0050.064.2	230 312	5,8 6,7	10/16 10/16		16	77 77	100 150	35,5 35,5	50 33	331469 331470
65	16	±20 = 40 ±40 = 80	0	16.0065.040.2 16.0065.080.2	260 362	8 9,4	10/16 10/16		16	92 92	130 200	52 52	133 85	331471 331472
80	16	±18 = 36 ±32 = 64	0	16.0080.036.2 16.0080.064.2	224 334	8,6 10,3	10/16 10/16		18	106 106	94 172	72,8 72,8	82 43	331473 331474
100	16	±22 = 44 ±40 = 80	0	16.0100.044.2 16.0100.080.2	240 394	10,1 12,8	10/16 10/16		18	130 132	110 214	115 115	109 102	331475 331476
125	16	±25 = 50 ±40 = 80	2	16.0125.050.3 16.0125.080.3	177 239	16 18	10/16	188	22	172 174	84 144	182 182	245 272	451578 452216
150	16	±28 = 56 ±40 = 80	2	16.0150.056.3 16.0150.080.3	187 226	20 23	10/16	212	24	203 204	90 128	260 261	240 220	452477 452478
200	16	±16 = 32 ±32 = 64	2	16.0200.032.3 16.0200.064.3	152 205	26 29	10	268	24	260 260	54 108	432 432	746 373	452453 452479
250	16	±20 = 40 ±35 = 70	2	16.0250.040.3 16.0250.070.3	187 244	38 41	10	320	26	318 318	76 133	665 665	567 324	452480 452481
300	16	±17 = 34 ±45 = 90	2	16.0300.034.3 16.0300.090.3	175 280	51 61	10	370	26	374 374	63 168	924 924	886 332	452482 452483

When ordering, please specify:

Type, nominal diameter (DN), axial movement absorption and overall length

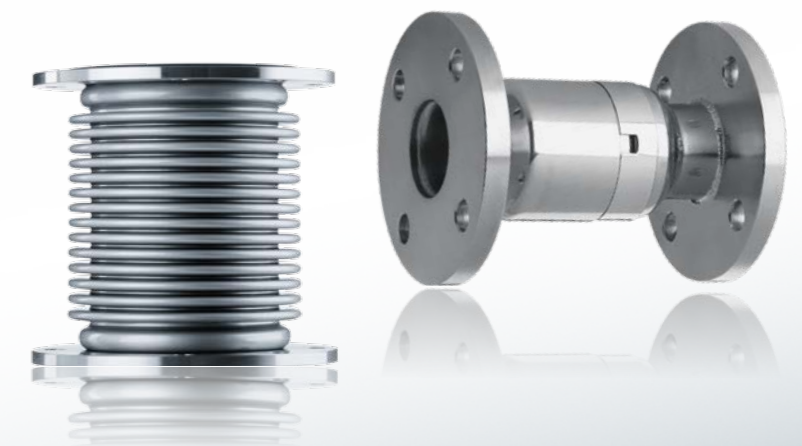

HYDRA® AXIAL EXPANSION JOINTS

Further axial expansion joint designs on request

Type ALN without inner sleeve

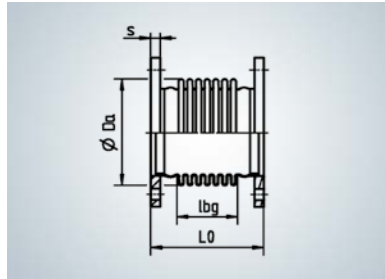

Type ABN without inner sleeve

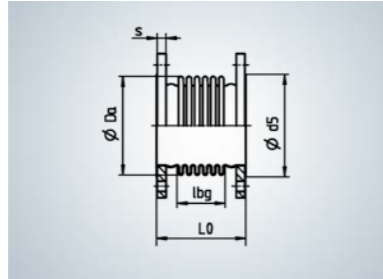

Type ALN + ABN – PN 16:
Axial expansion joint with swivel flanges

Design / Types

- Type ALN
- Type ABN

Dimensions

- Type ALN: DN 20 – DN 100
- Type ABN: DN 125 – DN 500

Material

- Multi-ply bellow made of stainless steel 1.4541
- Flanges: 1.0038

Our Approvals



Type ARN without inner sleeve

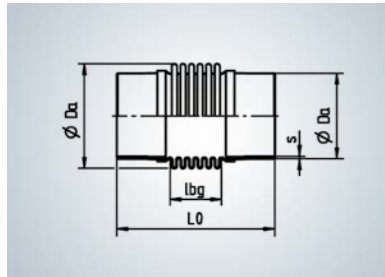

Type ARN with inner sleeve

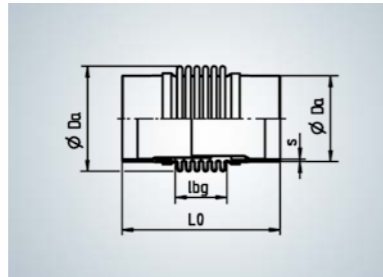

Type ARN – PN 16:
Axial expansion joint with weld ends

Design / Types

- Type ARN

Dimensions

- Type ARN: DN 20 – DN 100

Material

- Multi-ply bellow made of stainless steel 1.4571 or 1.4541
- Weld ends: 1.0305 (St 35.8)

Our Approvals



HYDRA® LATERAL EXPANSION JOINTS

Further lateral expansion joint designs on request

Type LBR

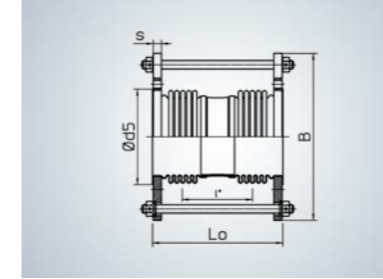

Type LBR – PN 16:
Lateral expansion joint with tie rod and non-swivel flanges

Design / Types

- Type LBR, for movement in all planes

Dimensions

- Type LBR: DN 50 – DN 500

Material

- Multi-ply bellow made of stainless steel: 1.4541
- Flanges: 1.0425

Our Approvals



Type LBS

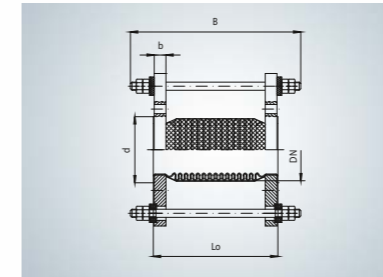

Type LBS – PN 16:
Lateral expansion joint with tie rod and non-swivel flanges

Design / Types

- Type LBS, for movement in all planes, noise-isolated

Dimensions

- Type LBS: DN 50 – DN 500

Material

- Multi-ply bellow made of stainless steel 1.4541
- Flanges: 1.0425

Our Approvals

