



# GE LAMPS CATALOG

LED & TRADITIONAL

2024

Current 

# Table of Contents

---

<b>INTRO: WE ARE .....</b>	<b>4</b>
<b>SELECTABLE LED LAMPS.....</b>	<b>6</b>
<b>LED LAMPS .....</b>	<b>8</b>
LED Lamps - Tubes .....	9
Type A (Ballast Compatible) .....	12
Type A+B (Dual Mode).....	17
Type B (Ballast Bypass) .....	18
Type C (Remote Driver).....	26
LED Lamps - HID .....	30
LED HID for Hazardous Locations .....	42
LED Lamps - Plug-in.....	46
Type A (Ballast Compatible) .....	48
Type B (Ballast Bypass) .....	50
LED Lamps - Directional .....	56
PARs .....	58
MR16s .....	60
RS Cans .....	62
Reflectors .....	64
LED Lamps - General Purpose .....	66
A-line .....	67
Decorative .....	70



# TRADITIONAL LAMPS & BALLASTS..... 74

Traditional Lamps.....	75
Linear Fluorescent Lamps .....	76
High Intensity Discharge Lamps .....	82
Compact Fluorescent Lamps.....	94
Halogen Lamps .....	98
Incandescent Lamps .....	101
Ballasts.....	105
Linear Fluorescent Ballasts .....	106
Compact Fluorescent Ballasts .....	132
Electromagnetic HID Ballasts .....	140

# APPENDIX.....154

# GLOSSARY OF TERMS .....155

GE Lamps provide unmatched  
**peace of mind.**



# We are:

## COMPLETE

Current's comprehensive offering of GE Lamps includes high performance LED lighting solutions in addition to popular Traditional products. GE Lamps cover a wide range of Linear Fluorescent, High Intensity Discharge, Compact Fluorescent, Halogen, Incandescent and Ballast applications.



## INNOVATIVE

Current's exceptional engineering professionals use deep knowledge of Traditional lamp applications to create industry-leading LED lamps that provide the right amount of light while saving energy and lasting longer. Use them to transform the look and efficiency of your facilities.

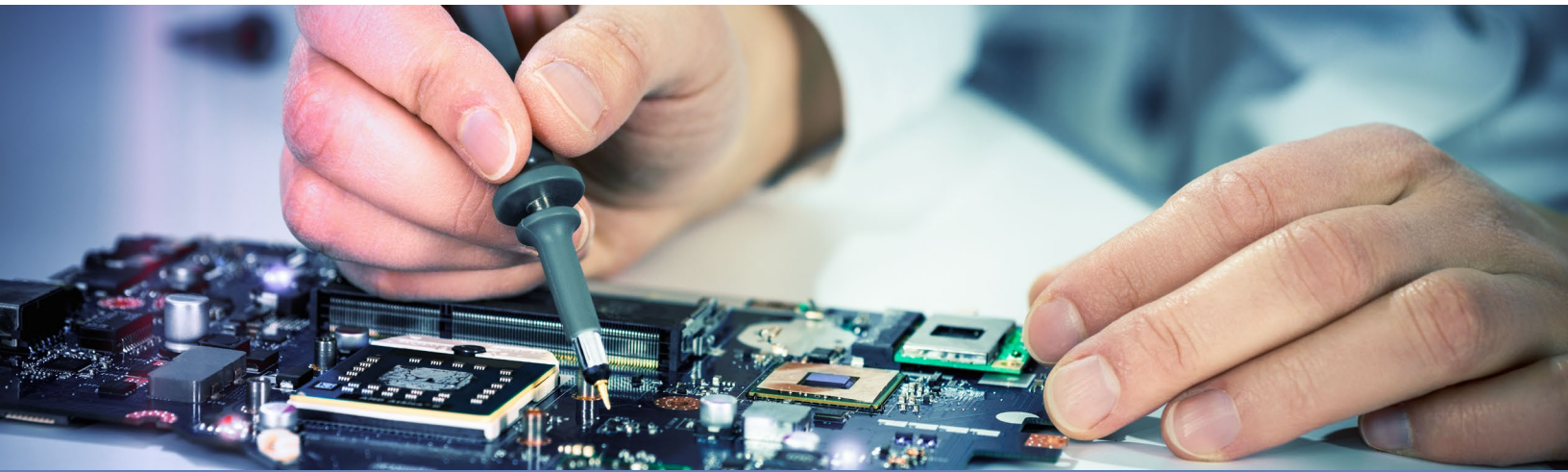



# DEPENDABLE

GE Lamps have provided the exceptional light quality that you know and love for years. Current's engineers continue to develop reliable GE LED Lamps that fit Traditional applications and meet industry standards for equivalency claims.



# TRUSTED

A reputation for quality and reliability is our legacy. Current continues the proud tradition today, creating GE LED Lamps that last up to 70,000 hours and delivering superior solutions for even the most challenging replacement lamp applications.



# Selectable LED Lamps



## LumenChoice®

Optimize light levels and power consumption instantly, maximizing energy savings immediately

Make lumen/wattage selections easily at any time with integrated switch, no tools required

## LumenChoice® + SpectraChoice™



## SpectraChoice™

Match the color of lighting across a facility or choose to change the aesthetic of a space

Make color temperature selections easily at any time with integrated switch, no tools required



pg. **20**  
LED Tubes



### Reduce Inventory

Reduce SKU count and inventory dollars



### Simplify Projects

Simplify BOMs, project management, MRO  
Maintain utility rebates



### Optimize Solutions

Create flexibility for  
installers to react on-site

Take **control** of your lighting & inventory with our full line of Selectable **LED Lamps**



pg. **34**

LED HID



pg. **46**

LED Plug-In



pg. **61**

LED RS Cans



pg. **65**

LED A-Line



# LED Lamps



# LED Lamps - Tubes



## Lamp Drawings (not drawn to scale)

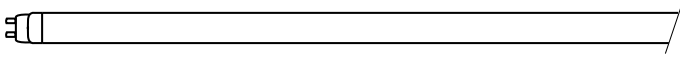

T5 (5/8" diameter) Miniature Bi-Pin Base (G5)

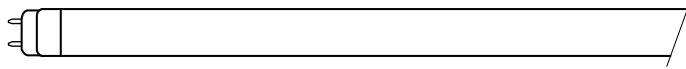

T8 (1" diameter) Medium Bi-Pin Base (G13)

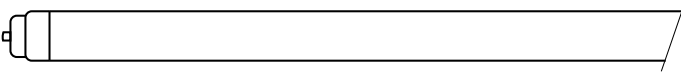

T8 (1" diameter) Single Pin Base (Fa8)

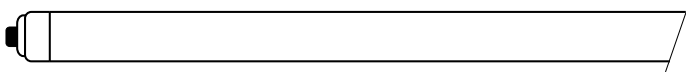

T8 (1" diameter) Recessed Double Contact Base (R17d)

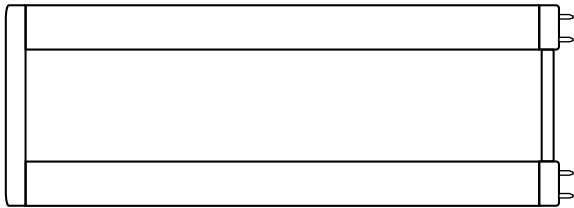

T8 (1" diameter) U6 Medium Bi-Pin Base (2G13)



T8 (1" diameter) U1-5/8 Medium Bi-Pin Base (2G13)

## Base Identification (not drawn to scale)



Min BiPin  
G5

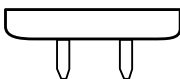

Med BiPin  
G13

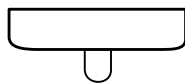

Single Pin  
Fa8

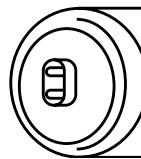

Recessed Double  
Contact  
R17D



# LED Lamps - Tubes

**LED Tubes**, sometimes referred to as "TLEDs," are meant to use linear fluorescent sockets and fixtures. LED Tubes have the same length and pins as the linear fluorescent lamps they are intended to replace. The details of how the fixture is wired and the auxiliary equipment used may vary, depending on the LED Tube solution.

The lighting industry refers to three basic Types of LED Tubes:

- **Type A LED Tubes** are intended to be used as direct replacements for linear fluorescent lamps, with no modification to the fixture. Type A LED Tubes operate from fluorescent ballasts.
- **Type B LED Tubes** operate from mains voltage. The ballast is bypassed and the fixture is re-wired according to the installation instructions that come with the lamp. Wiring may vary across Type B LED Tubes from different manufacturers. A retrofit fixture label indicating the LED Tube used and that the fixture has been re-wired is provided to be applied to the fixture.
- **Type C LED Tubes** operate from dedicated remote (external) LED drivers. Instead of a ballast, a remote driver is used to provide the proper voltage and current for the Type C LED Tubes. A retrofit fixture label indicating the LED Tube and Driver used is provided to be applied to the fixture. Type C LED Tube and Driver solutions vary across the industry – they are not yet standardized like linear fluorescent lamps and ballasts.

There are also "hybrid" lamps that can cover multiple Types of LED Tubes, depending on how they are implemented.

Current offers a wide range of GE LED Tubes to replace linear fluorescent lamps, including all of the Types above. Each Type of LED Tube offers different advantages, so the right solution may vary by application.

## Which LED Tube is right for you?

A basic comparison of the Types of LED Tubes is provided below. For more detailed information, please contact your Current sales representative.

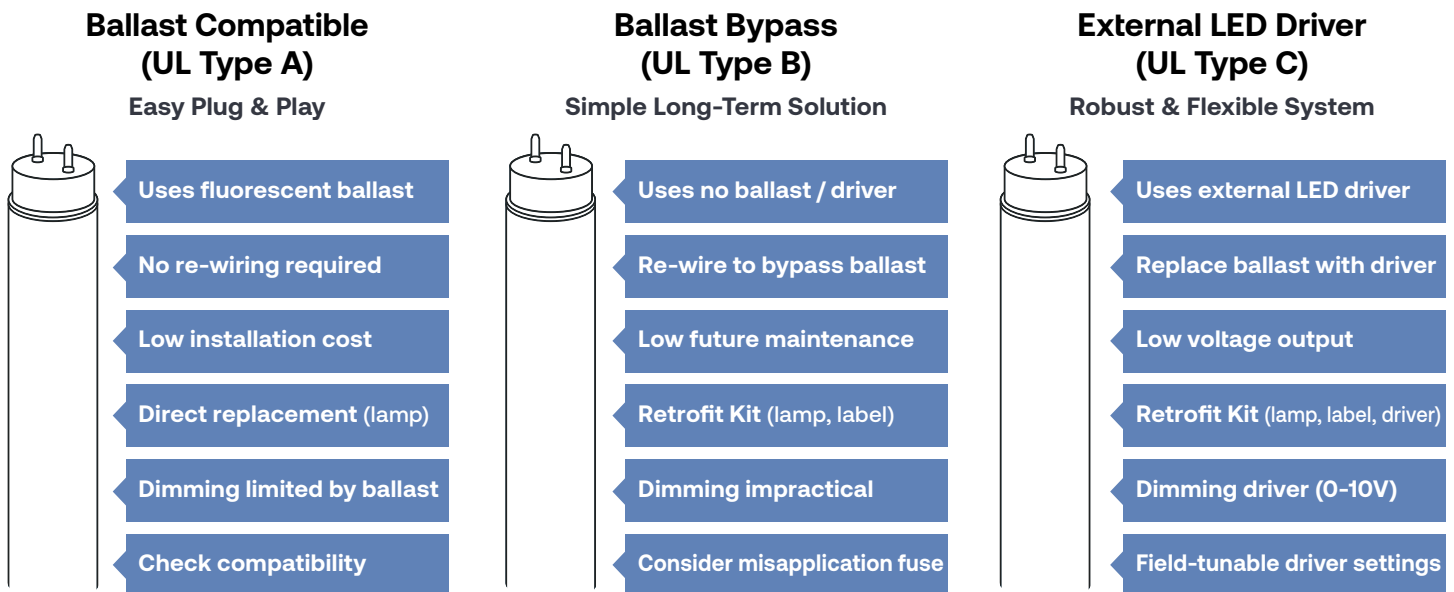

## LED Tube Wiring Basics:

The wiring diagrams below are provided as general guidance for GE LED Tubes. Other manufacturers' may vary. Refer to installation guides provided with GE LED Tubes for more detailed directions. If sockets are in good condition, no socket replacement should be necessary for GE LED Tubes. Add a jumper to non-shunted sockets, or tie both wires from a non-shunted socket to the incoming power as shown.

### Ballast Compatible (UL Type A)

Follow Ballast Wiring Diagram  
High Voltage Ballast Output to Sockets

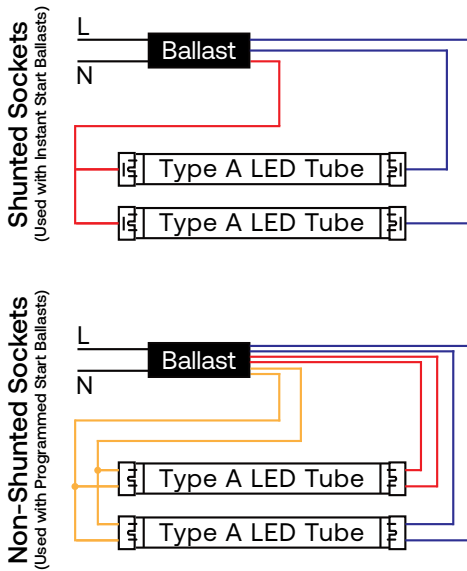

### Ballast Bypass (UL Type B)

Follow Lamp Wiring Diagram  
Mains Voltage AC to Sockets

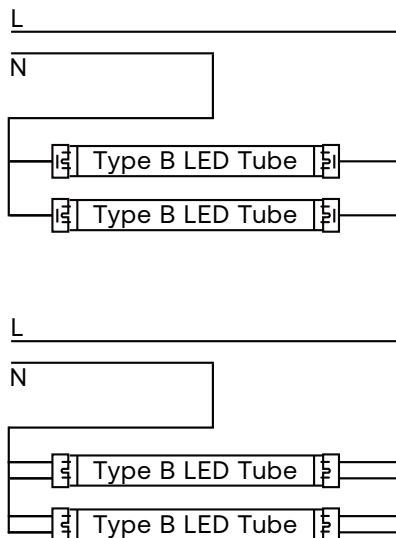

### External LED Driver (UL Type C)

Follow Driver Wiring Diagram  
Low Voltage DC Driver Output to Sockets

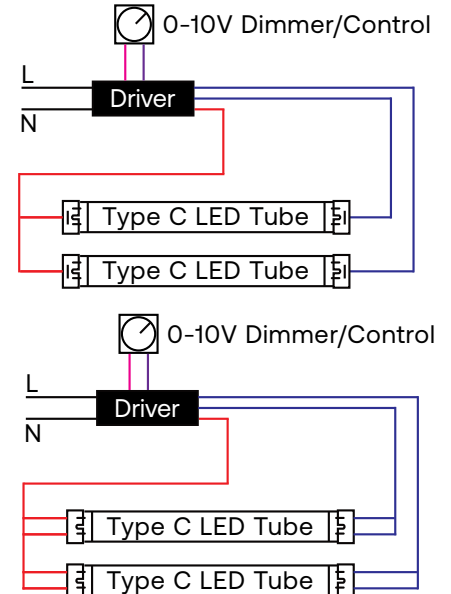

## LED Tube Construction, Coating, & covRguard®:

GE LED Tubes are primarily constructed of glass tubes with an internal coating for diffusion. This is similar to linear fluorescent construction that has been used for decades. Glass is a stable material and works well for most applications. The coating inside the glass provides good diffusion, spreading out the light and eliminating hot spots and pixilation from the individual LEDs.

GE LED Tubes are also offered with PET coating. This white coating is heat-shrunk onto a clear glass tube. Diffusion is supplied by the PET coating, which also provides some shatter resistance. These lamps are NSF Splash Zone rated.

GE LED Tubes are also available with covRguard®. Similar to covRguard® on linear fluorescent lamps, a polycarbonate sleeve is applied over the glass tube and affixed to the lamp end caps. This construction provides excellent shatter protection. These lamps are NSF Food Zone (Non-contact) rated.



# LED Lamps - Tubes - Type A



## LED Tubes - Type A

GE Type A LED Tubes offer a fast and easy upgrade to LED. No modification to the fixture is necessary. Simply replace the linear fluorescent lamp with the Type A LED Tube. The ballast remains in the circuit, powering the lamps. Confirm ballast compatibility at [www.LED.com/LEDTUBES-ballast-compatibility](http://www.LED.com/LEDTUBES-ballast-compatibility).

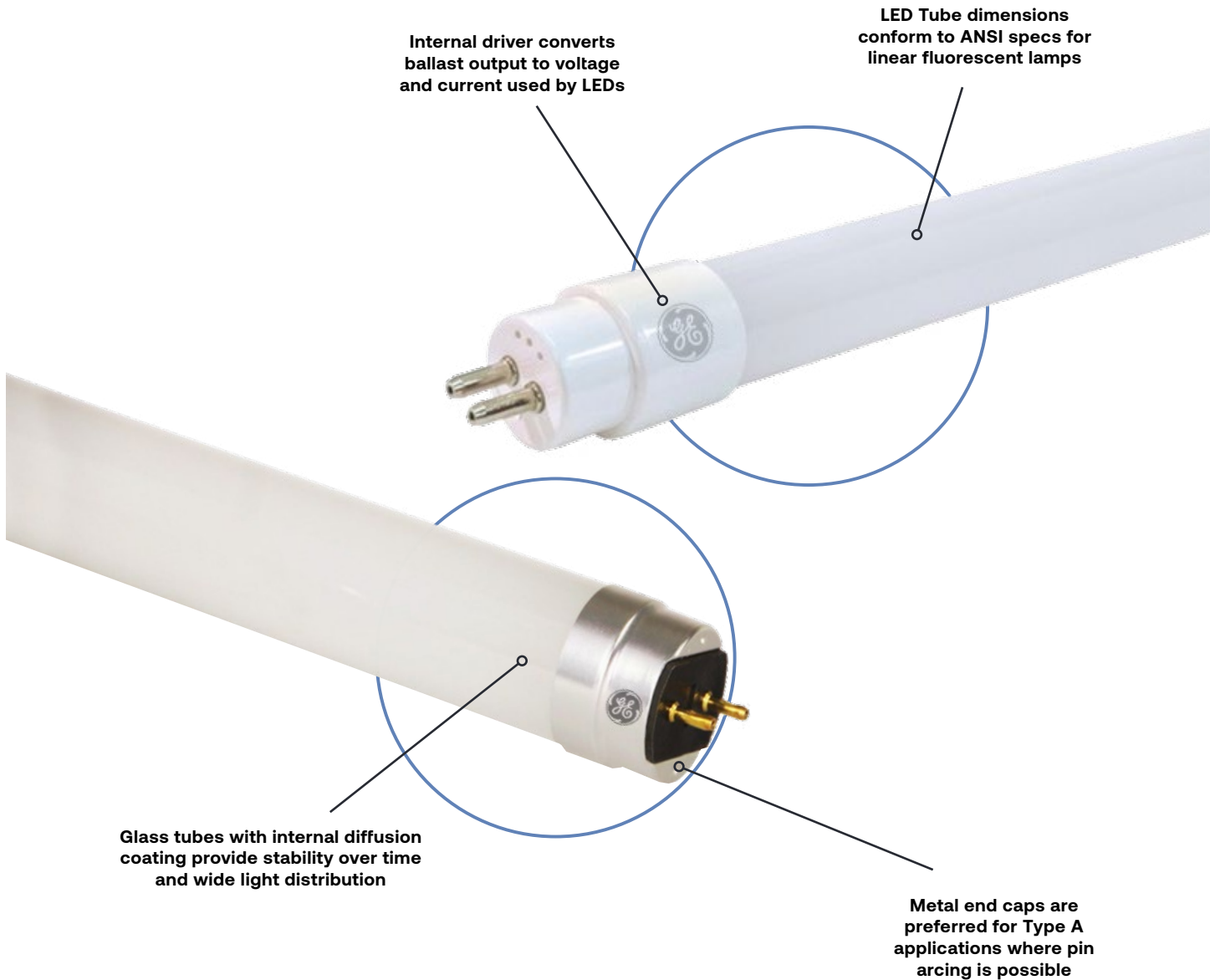

# LED Lamps - Tubes - Type A



## Catalog Logic:

### Bulb Shape:

Bulb shape followed by its size (the maximum diameter of the bulb expressed in eighths of an inch).

### Lamp Watts:

Typical Lamp Watts on Normal Ballast Factor (does not include ballast consumption)

### Order Code:

Use the order code when ordering to ensure that you receive the exact product you require

### Description:

Lamp Model Description

### Carton Quantity:

Number of lamps packed in a carton

### MOL (in):

Maximum Overall Length in inches

### System Watts:

Total input watts, including ballast and lamp consumption typical of each Ballast Factor

### Lumens (initial):

Typical lamp lumens when operating on each Ballast Factor

### Rated Life L70:

Hours of operation the lamp will provide before reaching 70% of its original lumen output

### Color Rendering Index (CRI or R):

An indication of the ability of the lamp to render object colors in a normal natural way. The higher the number (0-100), the better the color appearance.

### Color Temperature (K):

A measure of the visual "warmth" or "coolness" of the light from the lamp. The higher the value, the whiter or "cooler" the light appears.

### DLC:

Indicates whether product is listed on the DesignLights Consortium® Qualified Products List

### Location Rating:

Location Rating as defined for LED Lamps by UL 1993

### Additional Information:

Typical application and/or other important information.

Bulb Shape	Base Type	Lamp Watts <sup>5</sup>	Order Code	Description	Carton Qty <sup>2</sup>	MOL (in)	Low Ballast Factor		Normal Ballast Factor		High Ballast Factor		Color Temp (Initial)	CRI	Rated Life L70 (Hrs) <sup>1</sup>	DLC <sup>4</sup>	Location Rating <sup>3</sup>	Additional Information
							System Watts	Lumens (Initial)	System Watts	Lumens (Initial)	System Watts	Lumens (Initial)						
Integrated 4ft Glass Tubes (operates on Instant Start or Program Start Ballast)																		
T8	G13	18	35767	LED18ET8/G/4/830	20	48	17	2100	20	2500	26	3250	3000K	80	70,000	Yes	Damp	Instant or PRS Ballast

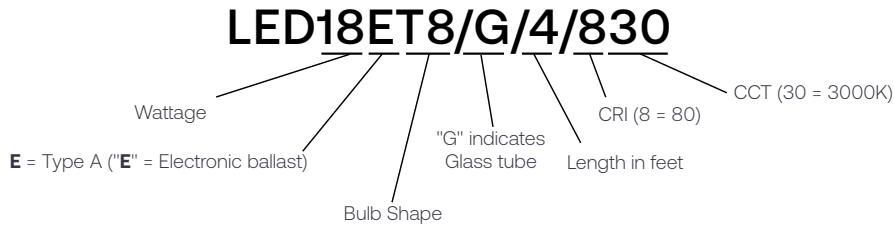

# LED Lamps - Tubes - Type A



## Integrated Glass Tubes - Type A

Bulb Shape	Base Type	Lamp Watts <sup>5</sup>	Order Code	Description	Carton Qty <sup>2</sup>	MOL (in)	Low Ballast Factor		Normal Ballast Factor		High Ballast Factor		Color Temp (Initial)	CRI	Rated Life L70 (Hrs) <sup>1</sup>	DLC <sup>4</sup> ID <sup>4</sup>	Location Rating <sup>3</sup>	Additional Information
							System Watts	Lumens (Initial)	System Watts	Lumens (Initial)	System Watts	Lumens (Initial)						
<b>Integrated 4ft Glass Tubes (operates on Instant Start or Program Start Ballast)</b>																		
T8	G13	18	35767	LED18ET8/G/4/830	20	48	17	2100	20	2500	26	3250	3000K	80	70,000	PXTA9H72	Damp	
	G13	18	35768	LED18ET8/G/4/835	20	48	17	2100	20	2500	26	3250	3500K	80	70,000	P3FTDF97	Damp	
	G13	18	35769	LED18ET8/G/4/840	20	48	17	2150	20	2600	26	3400	4000K	80	70,000	P9HNH1U8	Damp	
	G13	18	35772	LED18ET8/G/4/850	20	48	17	2150	20	2600	26	3400	5000K	80	70,000	PMHB5Y1H	Damp	
	G13	18	35773	LED10ET8/G/4/865	20	48	17	2150	20	2600	26	3400	6500K	80	70,000	-	Damp	
	G13	15	35790	LED15ET8/G/4/830	20	48	15	1850	17	2150	23	2900	3000K	80	70,000	PNH7QX7P	Damp	
	G13	15	35791	LED15ET8/G/4/835	20	48	15	1850	17	2200	23	2950	3500K	80	70,000	PC3FZA9X	Damp	
	G13	15	35793	LED15ET8/G/4/840	20	48	15	1950	17	2300	23	3100	4000K	80	70,000	PXTTMVUC	Damp	
	G13	15	35797	LED15ET8/G/4/850	20	48	15	1950	17	2300	23	3100	5000K	80	70,000	PDHK69J3	Damp	
	G13	15	35798	LED15ET8/G/4/865	20	48	15	1950	17	2300	23	3100	6500K	80	70,000	-	Damp	
	G13	10	34277	LED10ET8/G/4/830	20	48	11.5	1350	13	1600	17.5	2100	3000K	80	70,000	-	Damp	
	G13	10	34279	LED10ET8/G/4/835	20	48	11.5	1400	13	1600	17.5	2150	3500K	80	70,000	PRHQNZN1	Damp	
	G13	10	34280	LED10ET8/G/4/840	20	48	11.5	1450	13	1700	17.5	2300	4000K	80	70,000	P7YZOA29	Damp	
	G13	10	34282	LED10ET8/G/4/850	20	48	11.5	1450	13	1700	17.5	2300	5000K	80	70,000	PSVXE1E0	Damp	
<b>Integrated 4ft Value Glass Tubes (operates on Instant Start or Program Start Ballast)</b>																		
T8	G13	14	34283	LED14ET8/G/4/830	20	48	15	1700	17	2050	23	2700	3000K	80	50,000	P8P45K7K	Damp	
	G13	14	34289	LED14ET8/G/4/835	20	48	15	1700	17	2050	23	2700	3500K	80	50,000	PKO4WU91	Damp	
	G13	14	34291	LED14ET8/G/4/840	20	48	15	1750	17	2100	23	2750	4000K	80	50,000	PLVH468G	Damp	
	G13	14	34300	LED14ET8/G/4/850	20	48	15	1750	17	2100	23	2750	5000K	80	50,000	P1XY7L6	Damp	
	G13	11	93107390	LED11ET8/G/4/830	20	48	12.5	1450	14	1700	19	2300	3000K	80	50,000	-	Damp	
	G13	11	93107391	LED11ET8/G/4/835	20	48	12.5	1450	14	1700	19	2300	3500K	80	50,000	PTB81YWO	Damp	
	G13	11	93107392	LED11ET8/G/4/840	20	48	12.5	1450	14	1700	19	2300	4000K	80	50,000	PTIWPW1J	Damp	
	G13	11	93107393	LED11ET8/G/4/850	20	48	12.5	1450	14	1700	19	2300	5000K	80	50,000	PZ9A65MO	Damp	
<b>Integrated 3ft Glass Tubes (operates on Instant Start or Program Start Ballast)</b>																		
T8	G13	10.5	35783	LED11ET8/G/3/830	20	36	11.5	1350	13	1600	18	2150	3000K	80	70,000	PCEIN3O5	Damp	
	G13	10.5	35784	LED11ET8/G/3/835	20	36	11.5	1350	13	1600	18	2150	3500K	80	70,000	PL2XF8BQ	Damp	
	G13	10.5	35788	LED11ET8/G/3/840	20	36	11.5	1350	13	1600	18	2150	4000K	80	70,000	PFERF8MX	Damp	
	G13	10.5	35789	LED11ET8/G/3/850	20	36	11.5	1400	13	1650	18	2250	5000K	80	70,000	PQKLC9K	Damp	
<b>Integrated 2ft Glass Tubes (operates on Instant Start or Program Start Ballast)</b>																		
T8	G13	8.5	35775	LED8ET8/G/2/830	20	24	9.5	1200	11	1350	15	1850	3000K	80	70,000	-	Damp	
	G13	8.5	35776	LED8ET8/G/2/835	20	24	9.5	1200	11	1350	15	1850	3500K	80	70,000	PJDHZYEY	Damp	
	G13	8.5	35778	LED8ET8/G/2/840	20	24	9.5	1200	11	1350	15	1850	4000K	80	70,000	P557S4DE	Damp	
	G13	8.5	35779	LED8ET8/G/2/850	20	24	9.5	1200	11	1400	15	1950	5000K	80	70,000	P5UYRCN	Damp	

## Metric Integrated Glass Tubes - Type A

Bulb Shape	Base Type	Lamp Watts <sup>5</sup>	Order Code	Description	Carton Qty <sup>2</sup>	MOL (in)	Low Ballast Factor		Normal Ballast Factor		High Ballast Factor		Color Temp (Initial)	CRI	Rated Life L70 (Hrs) <sup>1</sup>	DLC <sup>4</sup> ID <sup>4</sup>	Location Rating <sup>3</sup>	Additional Information
							System Watts	Lumens (Initial)	System Watts	Lumens (Initial)	System Watts	Lumens (Initial)						
<b>Metric Integrated Glass Tubes (operates on Instant Start or Program Start Ballast)</b>																		
T8	G13	14	93312131	LED14ET8/G/835/METRIC	20	45.67	15	1700	17	2050	23	2700	3500K	80	50,000	-	Damp	
	G13	14	93312133	LED14ET8/G/840/METRIC	20	45.67	15	1750	17	2100	23	2750	4000K	80	50,000	-	Damp	

## Integrated Plastic Tubes - Type A

Bulb Shape	Base Type	Lamp Watts <sup>5</sup>	Order Code	Description	Carton Qty <sup>2</sup>	MOL (in)	Low Ballast Factor		Normal Ballast Factor		High Ballast Factor		Color Temp (Initial)	CRI	Rated Life L70 (Hrs) <sup>1</sup>	DLC <sup>4</sup> ID <sup>4</sup>	Location Rating <sup>3</sup>	Additional Information
							System Watts	Lumens (Initial)	System Watts	Lumens (Initial)	System Watts	Lumens (Initial)						
<b>Integrated U6 Plastic Tubes (operates on Instant Start or Program Start Ballast)</b>																		
T8-U6	2G13	13	43120	LED13ET8/U6/830	12	22.5	13	1500	15	1800	20.5	2400	3000K	80	50,000	P4CDITRI	Damp	
	2G13	13	43125	LED13ET8/U6/835	12	22.5	13	1550	15	1850	20.5	2450	3500K	80	50,000	PFX71YXR	Damp	
	2G13	13	43129	LED13ET8/U6/840	12	22.5	13	1600	15	1900	20.5	2500	4000K	80	50,000	PTEXOPXE	Damp	
	2G13	13	43130	LED13ET8/U6/850	12	22.5	13	1600	15	1900	20.5	2500	5000K	80	50,000	PSF41B80	Damp	

<sup>1</sup> The life rating is based on the hours of operation the lamp will provide before reaching 70% of its original lumen output (L70)

<sup>2</sup> Minimum order quantity = Carton Qty

<sup>3</sup> UL 1993 Environmental Requirements for LED LAMPS

Damp Location - Exterior or interior location that is normally or periodically subject to condensation of moisture in, on, or adjacent to electrical equipment, including partially protected locations

<sup>4</sup> Not all product variations on this page are DLC qualified. Visit [qpl.designlights.org/solid-state-lighting](http://qpl.designlights.org/solid-state-lighting) to confirm qualification.

<sup>5</sup> Bare lamp wattage operated on Normal Ballast Factor. Measured performance on Low (0.78), Normal (0.88) and High (1.18) Ballast Factors is provided for reference. Performance may vary depending on ballast model and age. Check ballast compatibility at [www.LED.com/LEDTUBES-ballast-compatibility](http://www.LED.com/LEDTUBES-ballast-compatibility).

# LED Lamps - Tubes - Type A



## Integrated covRguard® Plastic Sleeved Glass Tubes - Type A

Bulb Shape	Base Type	Lamp Watts <sup>5</sup>	Order Code	Description	Carton Qty <sup>2</sup>	MOL (in)	Low Ballast Factor		Normal Ballast Factor		High Ballast Factor		Color Temp (Initial)	CRI	Rated Life L70 (Hrs) <sup>1</sup>	DLC <sup>4</sup> ID <sup>4</sup>	Location Rating <sup>3</sup>	Additional Information
							System Watts	Lumens (Initial)	System Watts	Lumens (Initial)	System Watts	Lumens (Initial)						
<b>Integrated 4ft covRguard® Plastic Sleeved Glass Tubes (operates on Instant Start or Program Start Ballast)</b>																		
T8	G13	18	93135924	LED18ET8/G/4/830CVG	20	48	17	2050	20	2450	26	3200	3000K	80	70,000	PWZVF5V0	Damp	NSF Food Zone
	G13	18	93135946	LED18ET8/G/4/835CVG	20	48	17	2100	20	2500	26	3250	3500K	80	70,000	PF5EUKL2	Damp	NSF Food Zone
	G13	18	93135947	LED18ET8/G/4/840CVG	20	48	17	2100	20	2500	26	3250	4000K	80	70,000	PSKVG35W	Damp	NSF Food Zone
	G13	18	93135948	LED18ET8/G/4/850CVG	20	48	17	2150	20	2600	26	3400	5000K	80	70,000	P65JRO04	Damp	NSF Food Zone
	G13	15	93135823	LED15ET8/G/4/835CVG	20	48	15	1850	17	2200	23	2950	3500K	80	70,000	PYIS7JSD	Damp	NSF Food Zone
	G13	15	93135824	LED15ET8/G/4/840CVG	20	48	15	1850	17	2200	23	2950	4000K	80	70,000	PPXC7238	Damp	NSF Food Zone
	G13	15	93135846	LED15ET8/G/4/850CVG	20	48	15	1900	17	2250	23	3000	5000K	80	70,000	PU8LNXAM	Damp	NSF Food Zone
	G13	10	93135714	LED10ET8/G/4/835CVG	20	48	11.5	1400	13	1600	17.5	2150	3500K	80	70,000	PUCLMBOV	Damp	NSF Food Zone
	G13	10	93135715	LED10ET8/G/4/840CVG	20	48	11.5	1400	13	1600	17.5	2150	4000K	80	70,000	PUW18WQG	Damp	NSF Food Zone
	G13	10	93135716	LED10ET8/G/4/850CVG	20	48	11.5	1400	13	1650	17.5	2250	5000K	80	70,000	PI7FRGBP	Damp	NSF Food Zone
<b>Integrated 3ft covRguard® Plastic Sleeved Glass Tubes (operates on Instant Start or Program Start Ballast)</b>																		
T8	G13	10.5	93135659	LED11ET8/G/3/835CVG	20	36	11.5	1350	13	1600	18	2150	3500K	80	70,000	PSBVQAZE	Damp	NSF Food Zone
	G13	10.5	93135660	LED11ET8/G/3/840CVG	20	36	11.5	1350	13	1600	18	2150	4000K	80	70,000	P5QTVCPX	Damp	NSF Food Zone
	G13	10.5	93135661	LED11ET8/G/3/850CVG	20	36	11.5	1400	13	1650	18	2250	5000K	80	70,000	PJ78M875	Damp	NSF Food Zone
<b>Integrated 2ft covRguard® Plastic Sleeved Glass Tubes (operates on Instant Start or Program Start Ballast)</b>																		
T8	G13	8.5	93135655	LED8ET8/G/2/835CVG	20	24	9.5	1200	11	1350	15	1850	3500K	80	70,000	PVDR8UFU	Damp	NSF Food Zone
	G13	8.5	93135656	LED8ET8/G/2/840CVG	20	24	9.5	1200	11	1350	15	1850	4000K	80	70,000	PDP040JM	Damp	NSF Food Zone
	G13	8.5	93135657	LED8ET8/G/2/850CVG	20	24	9.5	1200	11	1350	15	1850	5000K	80	70,000	POY2CIVW	Damp	NSF Food Zone

## Integrated PET Plastic Coated Glass Tubes - Type A

Bulb Shape	Base Type	Lamp Watts <sup>5</sup>	Order Code	Description	Carton Qty <sup>2</sup>	MOL (in)	Low Ballast Factor		Normal Ballast Factor		High Ballast Factor		Color Temp (Initial)	CRI	Rated Life L70 (Hrs) <sup>1</sup>	DLC <sup>4</sup> ID <sup>4</sup>	Location Rating <sup>3</sup>	Additional Information
							System Watts	Lumens (Initial)	System Watts	Lumens (Initial)	System Watts	Lumens (Initial)						
<b>Integrated 4ft PET Plastic Coated Glass Tubes (operates on Instant Start or Program Start Ballast)</b>																		
T8	G13	14	93107394	LED14ET8/G4/830CT	20	48	15	1700	17	2050	23	2700	3000K	80	50,000	-	Damp	NSF Splash Zone
	G13	14	93107506	LED14ET8/G4/835CT	20	48	15	1700	17	2050	23	2700	3500K	80	50,000	PG06MMSK	Damp	NSF Splash Zone
	G13	14	93107507	LED14ET8/G4/840CT	20	48	15	1750	17	2100	23	2750	4000K	80	50,000	PI2340JJ	Damp	NSF Splash Zone
	G13	14	93107510	LED14ET8/G4/850CT	20	48	15	1750	17	2100	23	2750	5000K	80	50,000	PJ6AUR4D	Damp	NSF Splash Zone

<sup>1</sup> The life rating is based on the hours of operation the lamp will provide before reaching 70% of its original lumen output (L70)

<sup>2</sup> Minimum order quantity = Carton Qty

<sup>3</sup> UL 1993 Environmental Requirements for LED LAMPS

Damp Location - Exterior or interior location that is normally or periodically subject to condensation of moisture in, on, or adjacent to electrical equipment, including partially protected locations

<sup>4</sup> Not all product variations on this page are DLC qualified. Visit [qpl.designlights.org/solid-state-lighting](http://qpl.designlights.org/solid-state-lighting) to confirm qualification.

<sup>5</sup> Bare lamp wattage operated on Normal Ballast Factor. Measured performance on Low (0.78), Normal (0.88) and High (1.18) Ballast Factors is provided for reference. Performance may vary depending on ballast model and age. Check ballast compatibility at [www.LED.com/LEDTUBES-ballast-compatibility](http://www.LED.com/LEDTUBES-ballast-compatibility).

# LED Lamps - Tubes - Type A



## Integrated Glass Tubes - Type A - T5

Bulb Shape	Base Type	Lamp Watts <sup>5</sup>	Order Code	Description	Carton Qty <sup>2</sup>	MOL (in)	System Watts (BF=1.0)	Lumens (Initial)	Color Temp. (Initial)	CRI	Rated Life L70 (Hrs) <sup>1</sup>	DLC ID <sup>4</sup>	Location Rating <sup>3</sup>	Additional Information
<b>Integrated 4ft T5 HO Glass Tubes (operates on T5 Ballast)</b>														
T5	G5	25.5	19203	LED26ET5/G/4/830	20	46	32	3650	3000K	80	50,000	PWNBNEB9	Damp	Requires T5 HO Ballast
	G5	25.5	19221	LED26ET5/G/4/835	20	46	32	3750	3500K	80	50,000	POB2VN8V	Damp	Requires T5 HO Ballast
	G5	25.5	19227	LED26ET5/G/4/840	20	46	32	3800	4000K	80	50,000	PUS7DGWC	Damp	Requires T5 HO Ballast
	G5	25.5	19348	LED26ET5/G/4/850	20	46	32	3900	5000K	80	50,000	P99UF0IO	Damp	Requires T5 HO Ballast
	G5	25.5	19488	LED26ET5/G/4/865	20	46	32	3800	6500K	80	50,000	-	Damp	Requires T5 HO Ballast
<b>Integrated 2ft T5 HO Glass Tubes (operates on T5 Ballast)</b>														
T5	G5	11	34413	LED11ET5/G/2/830	20	22	13.5	1500	3000K	80	50,000	-	Damp	Requires T5 HO Ballast
	G5	11	34417	LED11ET5/G/2/835	20	22	13.5	1550	3500K	80	50,000	-	Damp	Requires T5 HO Ballast
	G5	11	34418	LED11ET5/G/2/840	20	22	13.5	1600	4000K	80	50,000	-	Damp	Requires T5 HO Ballast
	G5	11	34424	LED11ET5/G/2/850	20	22	13.5	1600	5000K	80	50,000	-	Damp	Requires T5 HO Ballast
<b>Integrated 4ft T5 HE Glass Tubes (operates on T5 Ballast)</b>														
T5	G5	13	34351	LED13ET5G4/830HE	20	46	16	1900	3000K	80	50,000	P3D2AHME	Damp	Requires T5 HE Ballast
	G5	13	34354	LED13ET5G4/835HE	20	46	16	1950	3500K	80	50,000	P9QL3V95	Damp	Requires T5 HE Ballast
	G5	13	34355	LED13ET5G4/840HE	20	46	16	2000	4000K	80	50,000	PIN820KS	Damp	Requires T5 HE Ballast
	G5	13	34367	LED13ET5G4/850HE	20	46	16	2000	5000K	80	50,000	PXRH4DM6	Damp	Requires T5 HE Ballast
<b>Integrated 3ft T5 HE Glass Tubes (operates on T5 Ballast)</b>														
T5	G5	10	34371	LED10ET5G3/830HE	20	34	13	1500	3000K	80	50,000	-	Damp	Requires T5 HE Ballast
	G5	10	34376	LED10ET5G3/835HE	20	34	13	1550	3500K	80	50,000	-	Damp	Requires T5 HE Ballast
	G5	10	34401	LED10ET5G3/840HE	20	34	13	1600	4000K	80	50,000	-	Damp	Requires T5 HE Ballast
	G5	10	34402	LED10ET5G3/850HE	20	34	13	1600	5000K	80	50,000	-	Damp	Requires T5 HE Ballast
<b>Integrated 2ft T5 HE Glass Tubes (operates on T5 Ballast)</b>														
T5	G5	7	34403	LED7ET5/G2/830HE	20	22	10	1000	3000K	80	50,000	-	Damp	Requires T5 HE Ballast
	G5	7	34404	LED7ET5/G2/835HE	20	22	10	1100	3500K	80	50,000	-	Damp	Requires T5 HE Ballast
	G5	7	34411	LED7ET5/G2/840HE	20	22	10	1150	4000K	80	50,000	-	Damp	Requires T5 HE Ballast
	G5	7	34412	LED7ET5/G2/850HE	20	22	10	1150	5000K	80	50,000	-	Damp	Requires T5 HE Ballast

<sup>1</sup> The life rating is based on the hours of operation the lamp will provide before reaching 70% of its original lumen output (L70)

<sup>2</sup> Minimum order quantity = Carton Qty

<sup>3</sup> UL 1993 Environmental Requirements for LED LAMPS

Damp Location – Exterior or interior location that is normally or periodically subject to condensation of moisture in, on, or adjacent to electrical equipment, including partially protected locations

<sup>4</sup> Not all product variations on this page are DLC qualified. Visit [qpl.designlights.org/solid-state-lighting](http://qpl.designlights.org/solid-state-lighting) to confirm qualification.

<sup>5</sup> Bare lamp wattage operated on T5 Ballasts. Measured performance on T5 ballasts (Ballast Factor = 1.0) is provided for reference. Performance may vary depending on ballast model and age.

Check ballast compatibility at [www.LED.com/LEDTUBES-ballast-compatibility](http://www.LED.com/LEDTUBES-ballast-compatibility).

# LED Lamps - Tubes - Type A+B



## Dual Mode Glass Tubes - Type A+B

GE Type A+B Tubes offer the flexibility to be used in either Type A (ballast driven) or Type B (ballast bypass) applications. The notes about each separate Type apply. Type A+B Tubes might be installed as Type A and then when the ballast fails or if it is found to be incompatible, switched to Type B. To use Type A+B lamps as Type B, the same re-wiring process must be done as for Type B lamps.

Bulb Shape	Base Type	Lamp Watts <sup>5</sup>	Order Code	Description	Carton Qty <sup>2</sup>	MOL (in)	TYPE A MODE				TYPE B MODE			Color Temp. (Initial)	Rated Life L70 (Hrs) <sup>1</sup>	DLC <sup>4</sup> ID <sup>4</sup>	Location Rating <sup>3</sup>				
							Low Ballast Factor		Normal Ballast Factor		High Ballast Factor		Input Voltage					Lumens (Initial)	Power Factor		
							System Watts	Lumens (Initial)	System Watts	Lumens (Initial)	System Watts	Lumens (Initial)									
<b>Dual Mode 4ft Glass Tubes (Type A+B)</b>																					
T8	G13	13	93138405	LED13ABT8/G4/830	25	48	14	1600	15.5	1850	N/A	N/A	120-277	13	1850	>0.9	80	3000K	50,000	PL3500YGQM9I	Damp
	G13	13	93138426	LED13ABT8/G4/835	25	48	14	1650	15.5	1900	N/A	N/A	120-277	13	1900	>0.9	80	3500K	50,000	PLCROKN6TTQ1	Damp
	G13	13	93138429	LED13ABT8/G4/840	25	48	14	1700	15.5	1950	N/A	N/A	120-277	13	1950	>0.9	80	4000K	50,000	PLC02LUI5ZEL	Damp
	G13	13	93138430	LED13ABT8/G4/850	25	48	14	1700	15.5	1950	N/A	N/A	120-277	13	1950	>0.9	80	5000K	50,000	PLFHM4HMHPY7	Damp

<sup>1</sup> The life rating is based on the hours of operation the lamp will provide before reaching 70% of its original lumen output (L70)

<sup>2</sup> Minimum order quantity = Carton Qty

<sup>3</sup> UL 1993 Environmental Requirements for LED LAMPS

Damp Location - Exterior or interior location that is normally or periodically subject to condensation of moisture in, on, or adjacent to electrical equipment, including partially protected locations

<sup>4</sup> Not all product variations on this page are DLC qualified. Visit [qpl.designlights.org/solid-state-lighting](http://qpl.designlights.org/solid-state-lighting) to confirm qualification.

<sup>5</sup> Bare lamp wattage operated on Normal Ballast Factor. Measured performance on Low (0.78), Normal (0.88) and High (1.18) Ballast Factors is provided for reference. Performance may vary depending on ballast model and age. Check ballast compatibility at [www.LED.com/LEDTUBES-ballast-compatibility](http://www.LED.com/LEDTUBES-ballast-compatibility).

# LED Lamps - Tubes - Type B



## LED Tubes - Type B

GE Type B LED Tubes offer a simple long-term solution for linear applications. The fixture is re-wired to bypass the ballast, taking mains voltage directly to the lampholders. This eliminates the ballast as a potential failure point, eliminates the ballast energy consumption and reduces future maintenance. GE Type B LED Tubes have multiple safety features designed into the lamp. Current also offers an external misapplication fuse kit for added protection and peace of mind.



# LED Lamps - Tubes - Type B



## Catalog Logic:

### Bulb Shape:

Bulb shape followed by its size (the maximum diameter of the bulb expressed in eighths of an inch)

### Watts:

Energy Used (as defined by FTC Lamp Label Rules)

### Description:

Lamp Model Description

### MOL (in):

Maximum Overall Length in inches

### Lumens:

Light output (as defined by FTC Lamp Label Rules)

### Rated Life L70:

Hours of operation the lamp will provide before reaching 70% of its original lumen output

### Color Temperature (K):

A measure of the visual "warmth" or "coolness" of the light from the lamp. The higher the value, the whiter or "cooler" the light appears.

### Power Factor:

A measure of the phase difference between voltage and current drawn by an electrical device

### Base Type:

ANSI Base

### Order Code:

Use the order code when ordering to ensure that you receive the exact product you require

### Carton Quantity:

Number of lamps packed in a carton

### Volts:

Lamp data is based on operation at rated voltage

### Color Rendering Index (CRI or R):

An indication of the ability of the lamp to render object colors in a normal, natural way. The higher the number (0-100), the better the color appearance.

### DLC:

Indicates whether product is listed on the DesignLights Consortium® Qualified Products List

### Location Rating:

Location Rating as defined for LED Lamps by UL 1993

### Additional Information:

Typical application and/or other important information

Bulb Shape	Base Type	Watts	Order Code	Description	Volts	Carton Qty <sup>2</sup>	MOL (in)	Lumens (Initial)	Color Temp. (Initial)	CRI	Rated Life L70 (Hrs) <sup>1</sup>	Power Factor	DLC <sup>3,4</sup>	Location Rating <sup>3</sup>	Additional Information
T8	G13	14	39498	LED14BDT8/G4/840	120-277	20	48	1800	4000K	80	50,000	>0.9	Yes	Damp	

## LED14BDT8/G4/840

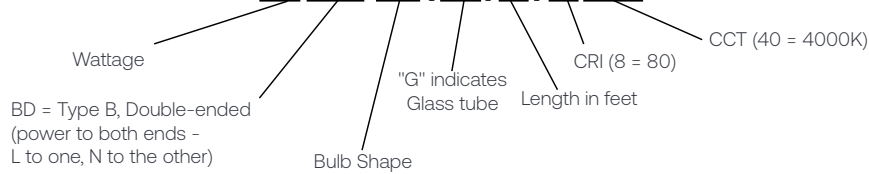



# LED Lamps - Tubes - Type B

Current offers unmatched flexibility in a single **Type B LED Tube**.  
Select wattage and color temperature at the flick of a switch.

LumenChoice® + SpectraChoice™ Selectable LED Tubes maximize the potential to reduce inventory and streamline product lists. These lamps allow installers to react to a wide variety of needs, providing the ability to adjust both the color temperature of the light and the brightness.

But what about when it's known a site prefers 4000K? LumenChoice® Selectable LED Tubes can be used to optimize the light levels throughout a facility with just one SKU. Reducing the wattage can save more energy and improve the comfortability of overlit spaces.



## LumenChoice®

Optimize light levels and power consumption instantly, maximizing energy savings immediately

Make lumen/wattage selections easily at any time with integrated switch, no tools required

# LumenChoice® + SpectraChoice™



## SpectraChoice™

Match the color of lighting across a facility or choose to change the aesthetic of a space

Make color temperature selections easily at any time with integrated switch, no tools required

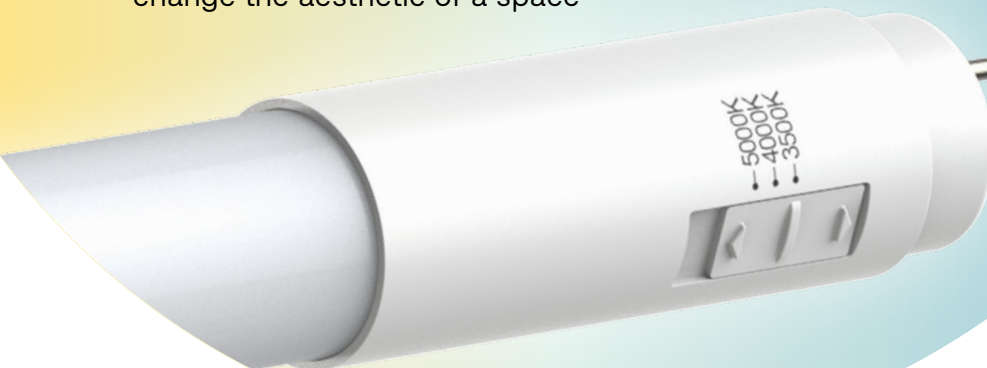

# LED Lamps - Tubes - Type B



## Ballast Bypass Selectable LumenChoice® + SpectraChoice™ Glass Tubes - Double Ended - Type B

Bulb Shape	Base Type	Selectable Watts*	Order Code	Description	Volts	Carton Qty <sup>2</sup>	MOL (in)	Selectable Lumens (Initial) <sup>5</sup>	Selectable Color Temp. (Initial)*	CRI	Rated Life L70 (Hrs) <sup>1</sup>	Power Factor	DLC* ID <sup>4</sup>	Location Rating <sup>3</sup>	Additional Information
<b>Ballast Bypass (Type B) - 4ft Glass Tubes</b>															
T8	G13	8 12* 16	93301824	LEDLCBDT8/G4/8SC	120-277	20	48	1100 1600* 2000	3500K 4000K* 5000K	80	70,000	>0.9	S-3Q0BDP	Damp	
T8	G13	10 13* 16	93313525	LEDLCBDT8/G4/8SCXL/120-347	120-347	20	48	1650 2050* 2550	3000K 3500K 4000K* 5000K	80	70,000	>0.9	S-3PNRN2	Damp	
<b>Ballast Bypass (Type B) - 3ft Glass Tubes</b>															
T8	G13	10 12* 14	93313565	LEDLCBDT8/G3/8SC/120-347	120-347	20	36	1400 1650* 1800	3000K 3500K 4000K* 5000K	80	70,000	>0.9	S-6N1DV1	Damp	
<b>Ballast Bypass (Type B) - 2ft Glass Tubes</b>															
T8	G13	7 9* 11	93313567	LEDLCBDT8/G2/8SC/120-347	120-347	20	24	950 1150* 1350	3000K 3500K 4000K* 5000K	80	70,000	>0.9	S-HXPL6T	Damp	

## Ballast Bypass Selectable LumenChoice® Glass Tubes - Double Ended - Type B

Bulb Shape	Base Type	Selectable Watts*	Order Code	Description	Volts	Carton Qty <sup>2</sup>	MOL (in)	Selectable Lumens (Initial) <sup>5</sup>	Color Temp. (Initial)	CRI	Rated Life L70 (Hrs) <sup>1</sup>	Power Factor	DLC* ID <sup>4</sup>	Location Rating <sup>3</sup>	Additional Information
<b>Ballast Bypass (Type B) - 4ft Glass Tubes</b>															
T8	G13	8 12* 16	93301783	LEDLCBDT8/G4/840	120-277	20	48	1100 1600* 2000	4000K	80	70,000	>0.9	S-Z2H9M3	Damp	

## Ballast Bypass Selectable SpectraChoice™ Glass Tubes - Double Ended - Type B

Bulb Shape	Base Type	Watts	Order Code	Description	Volts	Carton Qty <sup>2</sup>	MOL (in)	Lumens (Initial) <sup>5</sup>	Selectable Color Temp. (Initial)*	CRI	Rated Life L70 (Hrs) <sup>1</sup>	Power Factor	DLC* ID <sup>4</sup>	Location Rating <sup>3</sup>	Additional Information
<b>Ballast Bypass (Type B) - 4ft Glass Tubes</b>															
T8	G13	16	93313519	LED16BDT8/G4/8SCXL/120-347	120-347	20	48	2550	3000K 3500K 4000K* 5000K	80	70,000	>0.9	S-Y9PPM3	Damp	
T8	G13	13	93313501	LED13BDT8/G4/8SCXL/120-347	120-347	20	48	2050	3000K 3500K 4000K* 5000K	80	70,000	>0.9	S-77F6BV	Damp	
T8	G13	10	93313483	LED10BDT8/G4/8SCXL/120-347	120-347	20	48	1650	3000K 3500K 4000K* 5000K	80	70,000	>0.9	S-MY0H3W	Damp	

<sup>1</sup> The life rating is based on the hours of operation the lamp will provide before reaching 70% of its original lumen output (L70)

<sup>2</sup> Minimum order quantity from Current = Case Qty

<sup>3</sup> UL 1993 Environmental Requirements for LED LAMPS

Damp Location – Exterior or interior location that is normally or periodically subject to condensation of moisture in, on, or adjacent to electrical equipment, including partially protected locations

<sup>4</sup> Visit [qpl.designlights.org/solid-state-lighting](http://qpl.designlights.org/solid-state-lighting) to confirm qualification.

<sup>5</sup> Lumen levels correspond with wattage levels and represent 4000K setting.

\* Default wattage and color temperature settings noted by "\*" in tables above. Lumen levels correspond with wattage levels. Color temperature levels are independent of wattage & lumens.

# LED Lamps - Tubes - Type B



## Ballast Bypass Glass Tubes - Double Ended - Type B

Bulb Shape	Base Type	Watts	Order Code	Description	Volts	Carton Qty <sup>2</sup>	MOL (in)	Lumens (Initial)	Color Temp. (Initial)	CRI	Rated Life L70 (Hrs) <sup>1</sup>	Power Factor	DLC ID <sup>4</sup>	Location Rating <sup>3</sup>	Additional Information
<b>Ballast Bypass - 8ft Glass Tubes</b>															
T8	R17d	43	93132591	LED43BDT8/G8/835	120-277	20	96	5000	3500K	80	50,000	>0.9	-	Damp	
	R17d	43	93132592	LED43BDT8/G8/840	120-277	20	96	5500	4000K	80	50,000	>0.9	-	Damp	
	R17d	43	93132593	LED43BDT8/G8/850	120-277	20	96	5500	5000K	80	50,000	>0.9	-	Damp	
	Fa8	34	93122170	LED34BDT8/G/8/830	120-277	20	96	4000	3000K	80	50,000	>0.9	PLAZBRBXAMGI	Damp	
	Fa8	34	93122171	LED34BDT8/G/8/835	120-277	20	96	4000	3500K	80	50,000	>0.9	PL8W5U9U2C38	Damp	
	Fa8	34	93122172	LED34BDT8/G/8/840	120-277	20	96	4400	4000K	80	50,000	>0.9	PL9PNC3HLQNR	Damp	
	Fa8	34	93122174	LED34BDT8/G/8/850	120-277	20	96	4400	5000K	80	50,000	>0.9	PLXKM0YJFS3Q	Damp	
<b>Ballast Bypass - 4ft XL Glass Tubes</b>															
T8	G13	16	93132587	LED16BDT8/G4/835XL	120-277	20	48	2500	3500K	80	70,000	>0.9	P7A6TEUD	Damp	
	G13	16	93132588	LED16BDT8/G4/840XL	120-277	20	48	2550	4000K	80	70,000	>0.9	P32UZP06	Damp	
	G13	16	93132589	LED16BDT8/G4/850XL	120-277	20	48	2550	5000K	80	70,000	>0.9	P17ZR2DY	Damp	
	G13	13	93132552	LED13BDT8/G4/830XL	120-277	20	48	1950	3000K	80	70,000	>0.9	P20SWP4R	Damp	
	G13	13	93132553	LED13BDT8/G4/835XL	120-277	20	48	2000	3500K	80	70,000	>0.9	PY58DIYY	Damp	
	G13	13	93132554	LED13BDT8/G4/840XL	120-277	20	48	2050	4000K	80	70,000	>0.9	PN3DG2KK	Damp	
	G13	13	93132555	LED13BDT8/G4/850XL	120-277	20	48	2050	5000K	80	70,000	>0.9	P33RC00B	Damp	
	G13	9.5	93132549	LED9BDT8/G4/835XL	120-277	20	48	1600	3500K	80	70,000	>0.9	PP3H2D0T	Damp	
	G13	9.5	93132550	LED9BDT8/G4/840XL	120-277	20	48	1650	4000K	80	70,000	>0.9	PE3WWYH0	Damp	
	G13	9.5	93132551	LED9BDT8/G4/850XL	120-277	20	48	1650	5000K	80	70,000	>0.9	P4X8QYGU	Damp	
	<b>Ballast Bypass - 4ft Glass Tubes</b>														
T8	G13	16	93123476	LED16BDT8/G4/830	120-277	20	48	2100	3000K	80	50,000	>0.9	P9U8R2XF	Damp	
	G13	16	93125618	LED16BDT8/G4/835	120-277	20	48	2150	3500K	80	50,000	>0.9	PW61S4V8	Damp	
	G13	16	93125620	LED16BDT8/G4/840	120-277	20	48	2200	4000K	80	50,000	>0.9	PLWETXLG	Damp	
	G13	16	93125622	LED16BDT8/G4/850	120-277	20	48	2200	5000K	80	50,000	>0.9	P9DPDUA6	Damp	
	G13	14	39493	LED14BDT8/G4/830	120-277	20	48	1700	3000K	80	50,000	>0.9	PQJU40YO	Damp	
	G13	14	39494	LED14BDT8/G4/835	120-277	20	48	1750	3500K	80	50,000	>0.9	PE7DNV4V	Damp	
	G13	14	39498	LED14BDT8/G4/840	120-277	20	48	1800	4000K	80	50,000	>0.9	PFXFRIB9	Damp	
	G13	14	39519	LED14BDT8/G4/850	120-277	20	48	1850	5000K	80	50,000	>0.9	PYXSAU7Y	Damp	
	G13	11	93117212	LED11BDT8/G4/830	120-277	20	48	1600	3000K	80	50,000	>0.9	-	Damp	
	G13	11	93117213	LED11BDT8/G4/835	120-277	20	48	1650	3500K	80	50,000	>0.9	P1AW5HB	Damp	
	G13	11	93117214	LED11BDT8/G4/840	120-277	20	48	1650	4000K	80	50,000	>0.9	P3Y9GW4E	Damp	
	G13	11	93117215	LED11BDT8/G4/850	120-277	20	48	1700	5000K	80	50,000	>0.9	P792993K	Damp	
	<b>Ballast Bypass - 3ft Glass Tubes</b>														
T8	G13	12	39525	LED12BDT8/G3/830	120-277	20	36	1450	3000K	80	50,000	>0.9	P7PGZZMI	Damp	
	G13	12	39547	LED12BDT8/G3/835	120-277	20	36	1500	3500K	80	50,000	>0.9	P1DV4D7M	Damp	
	G13	12	39554	LED12BDT8/G3/840	120-277	20	36	1550	4000K	80	50,000	>0.9	POEU7LZC	Damp	
	G13	12	39557	LED12BDT8/G3/850	120-277	20	36	1550	5000K	80	50,000	>0.9	P1WXGHZO	Damp	
<b>Ballast Bypass - 2ft Glass Tubes</b>															
T8	G13	9	39558	LED9BDT8/G2/830	120-277	20	24	1100	3000K	80	50,000	>0.9	PW6GB7O3	Damp	
	G13	9	39560	LED9BDT8/G2/835	120-277	20	24	1150	3500K	80	50,000	>0.9	P41DJP7N	Damp	
	G13	9	39561	LED9BDT8/G2/840	120-277	20	24	1200	4000K	80	50,000	>0.9	P9VLH47P	Damp	
	G13	9	39563	LED9BDT8/G2/850	120-277	20	24	1200	5000K	80	50,000	>0.9	PQJS5X3I	Damp	
<b>Ballast Bypass - U1 Glass Tubes - 1-5/8" leg spacing</b>															
T8-U1	2G13	13	93107352	LED13BDT8/U/835	120-277	20	22.5	1800	3500K	80	50,000	>0.9	PUORES80	Damp	1 - 5/8" leg spacing
	2G13	13	93107388	LED13BDT8/U/840	120-277	20	22.5	1850	4000K	80	50,000	>0.9	PA21GLQ2	Damp	1 - 5/8" leg spacing
	2G13	13	93107389	LED13BDT8/U/850	120-277	20	22.5	1850	5000K	80	50,000	>0.9	PGEE9WIZ	Damp	1 - 5/8" leg spacing
<b>Ballast Bypass - U6 Glass Tubes - 6" leg spacing</b>															
T8-U6	2G13	13	93133049	LED13BDT8/U6/830	120-277	12	22.5	1750	3000K	80	50,000	>0.9	PEW9A1M8	Damp	6" leg spacing
	2G13	13	93133050	LED13BDT8/U6/835	120-277	12	22.5	1800	3500K	80	50,000	>0.9	PWUWR50L	Damp	6" leg spacing
	2G13	13	93133051	LED13BDT8/U6/840	120-277	12	22.5	1850	4000K	80	50,000	>0.9	P5NYY5PI	Damp	6" leg spacing
	2G13	13	93133052	LED13BDT8/U6/850	120-277	12	22.5	1850	5000K	80	50,000	>0.9	PWD1ZSNP	Damp	6" leg spacing

<sup>1</sup> The life rating is based on the hours of operation the lamp will provide before reaching 70% of its original lumen output (L70)

<sup>2</sup> Minimum order quantity from Current = Carton Qty

<sup>3</sup> UL 1993 Environmental Requirements for LED LAMPS

Damp Location - Exterior or interior location that is normally or periodically subject to condensation of moisture in, on, or adjacent to electrical equipment, including partially protected locations

<sup>4</sup> Not all product variations on this page are DLC qualified. Visit [apl.designights.org/solid-state-lighting](http://apl.designights.org/solid-state-lighting) to confirm qualification.

\* Default color temperature setting is 4000K.

# LED Lamps - Tubes - Type B



## Ballast Bypass covRguard® Plastic Sleeved Glass Tubes - Double Ended - Type B

Bulb Shape	Base Type	Watts	Order Code	Description	Volts	Carton Qty <sup>2</sup>	MOL (in)	Lumens (Initial)	Color Temp. (Initial)	CRI	Rated Life L70 (Hrs) <sup>1</sup>	Power Factor	DLC <sup>3</sup> ID <sup>4</sup>	Location Rating <sup>3</sup>	Additional Information
<b>Ballast Bypass - 4ft covRguard® Plastic Sleeved Glass Tubes</b>															
T8	G13	16	93154588	LED16BDT8/G4/835XL/CVG	120-277	20	48	2400	3500K	80	70,000	>0.9	S-HSC8PZ	Damp	NSF Food Zone
	G13	16	93154589	LED16BDT8/G4/840XL/CVG	120-277	20	48	2450	4000K	80	70,000	>0.9	S-KDB8N5	Damp	NSF Food Zone
	G13	16	93154586	LED16BDT8/G4/850XL/CVG	120-277	20	48	2450	5000K	80	70,000	>0.9	S-398HOM	Damp	NSF Food Zone
	G13	13	93154613	LED13BDT8/G4/835XL/CVG	120-277	20	48	1900	3500K	80	70,000	>0.9	S-PTI7MQ	Damp	NSF Food Zone
	G13	13	93154590	LED13BDT8/G4/840XL/CVG	120-277	20	48	1950	4000K	80	70,000	>0.9	S-HVKBRT	Damp	NSF Food Zone
	G13	13	93154612	LED13BDT8/G4/850XL/CVG	120-277	20	48	1950	5000K	80	70,000	>0.9	S-7VT10C	Damp	NSF Food Zone
	G13	9	93154615	LED9BDT8/G4/835XL/CVG	120-277	20	48	1550	3500K	80	70,000	>0.9	-	Damp	NSF Food Zone
	G13	9	93154616	LED9BDT8/G4/840XL/CVG	120-277	20	48	1600	4000K	80	70,000	>0.9	S-DEZYCO	Damp	NSF Food Zone

## Ballast Bypass PET Plastic Coated Glass Tubes - Double Ended - Type B

Bulb Shape	Base Type	Watts	Order Code	Description	Volts	Carton Qty <sup>2</sup>	MOL (in)	Lumens (Initial)	Color Temp. (Initial)	CRI	Rated Life L70 (Hrs) <sup>1</sup>	Power Factor	DLC <sup>3</sup> ID <sup>4</sup>	Location Rating <sup>3</sup>	Additional Information
<b>Ballast Bypass - 4ft PET Plastic Coated Glass Tubes</b>															
T8	G13	14	93123124	LED14BDT8/G4/835CT	120-277	20	48	1750	3500K	80	50,000	>0.9	PK9D9IG0	Damp	NSF Splash Zone
	G13	14	93123316	LED14BDT8/G4/840CT	120-277	20	48	1750	4000K	80	50,000	>0.9	P9R85C2W	Damp	NSF Splash Zone
	G13	14	93123317	LED14BDT8/G4/850CT	120-277	20	48	1800	5000K	80	50,000	>0.9	PZL4PN19	Damp	NSF Splash Zone
	G13	11	93129666	LED11BDT8/G4/840CT	120-277	20	48	1650	4000K	80	50,000	>0.9	PKJQYIAK	Damp	NSF Splash Zone
<b>Ballast Bypass - 3ft LED Tube - PET Plastic Coated Glass</b>															
T8	G13	12	93154450	LED12BDT8/G3/840CT	120-277	20	36	1450	4000K	80	50,000	>0.9	S-UYXL72	Damp	NSF Splash Zone
<b>Ballast Bypass - 2ft LED Tube - PET Plastic Coated Glass</b>															
T8	G13	9	93154445	LED9BDT8/G2/840CT	120-277	20	24	1100	4000K	80	50,000	>0.9	S-K7HOSB	Damp	NSF Splash Zone

## 120-347V Ballast Bypass Glass Tubes - Double Ended - Type B

Bulb Shape	Base Type	Watts	Order Code	Description	Volts	Carton Qty <sup>2</sup>	MOL (in)	Lumens (Initial)	Color Temp. (Initial)	CRI	Rated Life L70 (Hrs) <sup>1</sup>	Power Factor	DLC <sup>3</sup> ID <sup>4</sup>	Location Rating <sup>3</sup>	Additional Information
<b>120-347V Ballast Bypass - 8ft Glass Tubes</b>															
T8	R17d	42	93309189	LED42BDT8/G8/R17d/840/120-347	120-347	20	96	5500	4000K	80	50,000	>0.9	-	Damp	
	R17d	42	93309190	LED42BDT8/G8/R17d/850/120-347	120-347	20	96	5500	5000K	80	50,000	>0.9	-	Damp	
	Fa8	42	93309184	LED42BDT8/G8/Fa8/835/120-347	120-347	20	96	5400	3500K	80	50,000	>0.9	S-N56DBF	Damp	
	Fa8	42	93309185	LED42BDT8/G8/Fa8/840/120-347	120-347	20	96	5500	4000K	80	50,000	>0.9	S-J9A14Z	Damp	
	Fa8	42	93309186	LED42BDT8/G8/Fa8/850/120-347	120-347	20	96	5500	5000K	80	50,000	>0.9	S-4FRUT9	Damp	
<b>120-347V Ballast Bypass - 4ft Glass Tubes</b>															
T8	G13	15	93150744	LED15BDT8/G4/830/120-347	120-347	20	48	2000	3000K	80	50,000	>0.9	PLEZ25LCZ18C	Damp	
	G13	15	93150745	LED15BDT8/G4/835/120-347	120-347	20	48	2100	3500K	80	50,000	>0.9	PL3AD91YOVYI	Damp	
	G13	15	93150774	LED15BDT8/G4/840/120-347	120-347	20	48	2200	4000K	80	50,000	>0.9	PLAVADEOC20D	Damp	
	G13	15	93150775	LED15BDT8/G4/850/120-347	120-347	20	48	2200	5000K	80	50,000	>0.9	PLMTIE87F98F	Damp	
	G13	11.5	93305112	LED11BDT8/G4/830/120-347	120-347	20	48	1700	3000K	80	50,000	>0.9	S-P96STW	Damp	
	G13	11.5	93305113	LED11BDT8/G4/835/120-347	120-347	20	48	1750	3500K	80	50,000	>0.9	S-FK874T	Damp	
	G13	11.5	93305115	LED11BDT8/G4/840/120-347	120-347	20	48	1800	4000K	80	50,000	>0.9	S-RBECUJ	Damp	
	G13	11.5	93305116	LED11BDT8/G4/850/120-347	120-347	20	48	1800	5000K	80	50,000	>0.9	S-32DTWS	Damp	
<b>120-347V Ballast Bypass - 3ft Glass Tubes</b>															
T8	G13	12	93309175	LED12BDT8/G3/830/120-347	120-347	20	36	1500	3000K	80	50,000	>0.9	S-1A830D	Damp	
	G13	12	93309176	LED12BDT8/G3/835/120-347	120-347	20	36	1550	3500K	80	50,000	>0.9	S-XIZYOE	Damp	
	G13	12	93309177	LED12BDT8/G3/840/120-347	120-347	20	36	1600	4000K	80	50,000	>0.9	S-4DQ73F	Damp	
	G13	12	93309178	LED12BDT8/G3/850/120-347	120-347	20	36	1600	5000K	80	50,000	>0.9	S-CDWEX5	Damp	
<b>120-347V Ballast Bypass - 2ft Glass Tubes</b>															
T8	G13	7	93309179	LED7BDT8/G2/830/120-347	120-347	20	24	900	3000K	80	50,000	>0.9	S-G73A5R	Damp	
	G13	7	93309180	LED7BDT8/G2/835/120-347	120-347	20	24	925	3500K	80	50,000	>0.9	S-WVHQ2L	Damp	
	G13	7	93309181	LED7BDT8/G2/840/120-347	120-347	20	24	950	4000K	80	50,000	>0.9	S-OL6XNA	Damp	
	G13	7	93309182	LED7BDT8/G2/850/120-347	120-347	20	24	950	5000K	80	50,000	>0.9	S-ZTFN9K	Damp	

<sup>1</sup> The life rating is based on the hours of operation the lamp will provide before reaching 70% of its original lumen output (L70)

<sup>2</sup> Minimum order quantity - Carton Qty

<sup>3</sup> UL 1993 Environmental Requirements for LED LAMPS

Damp Location - Exterior or interior location that is normally or periodically subject to condensation of moisture in, on, or adjacent to electrical equipment, including partially protected locations

<sup>4</sup> Not all product variations on this page are DLC qualified. Visit [qpl.designlights.org/solid-state-lighting](http://qpl.designlights.org/solid-state-lighting) to confirm qualification.

# LED Lamps - Tubes - Type B



## Ballast Bypass Glass Tubes - Double Ended - Type B - T5

Bulb Shape	Base Type	Watts	Order Code	Description	Volts	Carton Qty <sup>2</sup>	MOL (in)	Lumens (Initial)	Color Temp. (Initial)	CRI	Rated Life L70 (Hrs) <sup>1</sup>	Power Factor	DLC ID <sup>4</sup>	Location Rating <sup>3</sup>	Additional Information
<b>Ballast Bypass - 4ft T5 HO Glass Tubes</b>															
T5	G5	25	93100292	LED25BDT5/G4/830	120-277	20	46	3300	3000K	80	50,000	>0.9	P10ID184	Damp	
	G5	25	93100293	LED25BDT5/G4/835	120-277	20	46	3400	3500K	80	50,000	>0.9	PNWXCFY	Damp	
	G5	25	93100294	LED25BDT5/G4/840	120-277	20	46	3500	4000K	80	50,000	>0.9	P56WVBL6	Damp	
	G5	25	93100295	LED25BDT5/G4/850	120-277	20	46	3600	5000K	80	50,000	>0.9	P95QEGYA	Damp	
<b>Ballast Bypass - 3ft T5 HO Glass Tubes</b>															
T5	G5	17	93114325	LED17BDT5/G3/830	120-277	20	34	2300	3000K	80	50,000	>0.9	-	Damp	
	G5	17	93114626	LED17BDT5/G3/835	120-277	20	34	2400	3500K	80	50,000	>0.9	-	Damp	
	G5	17	93114629	LED17BDT5/G3/840	120-277	20	34	2500	4000K	80	50,000	>0.9	-	Damp	
	G5	17	93114814	LED17BDT5/G3/850	120-277	20	34	2550	5000K	80	50,000	>0.9	-	Damp	
<b>Ballast Bypass - 2ft T5 HO Glass Tubes</b>															
T5	G5	11	93113793	LED11BDT5/G2/830	120-277	20	22	1500	3000K	80	50,000	>0.9	-	Damp	
	G5	11	93114322	LED11BDT5/G2/835	120-277	20	22	1550	3500K	80	50,000	>0.9	-	Damp	
	G5	11	93114323	LED11BDT5/G2/840	120-277	20	22	1600	4000K	80	50,000	>0.9	-	Damp	
	G5	11	93114324	LED11BDT5/G2/850	120-277	20	22	1650	5000K	80	50,000	>0.9	-	Damp	
<b>Ballast Bypass - 4ft T5 HE Glass Tubes</b>															
T5	G5	14	93128354	LED14BDT5G4830HE	120-277	20	46	2050	3000K	80	50,000	>0.9	PBJIKOYW	Damp	
	G5	14	93128355	LED14BDT5G4835HE	120-277	20	46	2100	3500K	80	50,000	>0.9	PLB3DOM0	Damp	
	G5	14	93128486	LED14BDT5G4840HE	120-277	20	46	2150	4000K	80	50,000	>0.9	P80DMFGU	Damp	
	G5	14	93128487	LED14BDT5G4850HE	120-277	20	46	2150	5000K	80	50,000	>0.9	PUPW4QP0	Damp	
<b>Ballast Bypass - 3ft T5 HE Glass Tubes</b>															
T5	G5	11	93128488	LED11BDT5G3830HE	120-277	20	34	1600	3000K	80	50,000	>0.9	-	Damp	
	G5	11	93128490	LED11BDT5G3835HE	120-277	20	34	1650	3500K	80	50,000	>0.9	-	Damp	
	G5	11	93128491	LED11BDT5G3840HE	120-277	20	34	1700	4000K	80	50,000	>0.9	-	Damp	
	G5	11	93128492	LED11BDT5G3850HE	120-277	20	34	1700	5000K	80	50,000	>0.9	-	Damp	
<b>Ballast Bypass - 2ft T5 HE Glass Tubes</b>															
T5	G5	9	93128494	LED9BDT5G2/830HE	120-277	20	22	1250	3000K	80	50,000	>0.9	-	Damp	
	G5	9	93128495	LED9BDT5G2/835HE	120-277	20	22	1300	3500K	80	50,000	>0.9	-	Damp	
	G5	9	93128570	LED9BDT5G2/840HE	120-277	20	22	1350	4000K	80	50,000	>0.9	-	Damp	
	G5	9	93128571	LED9BDT5G2/850HE	120-277	20	22	1350	5000K	80	50,000	>0.9	-	Damp	

## Ballast Bypass covrGuard® Plastic Sleeved Glass Tubes - Double Ended - Type B - T5

Bulb Shape	Base Type	Watts	Order Code	Description	Volts	Carton Qty <sup>2</sup>	MOL (in)	Lumens (Initial)	Color Temp. (Initial)	CRI	Rated Life L70 (Hrs) <sup>1</sup>	Power Factor	DLC ID <sup>4</sup>	Location Rating <sup>3</sup>	Additional Information
<b>Ballast Bypass - 4ft covrGuard® Plastic Sleeved Glass Tubes</b>															
T5	G5	25	93155904	LED25BDT5/G4/840/CVG	120-277	20	46	3400	4000K	80	50,000	>0.9	S-60DSL	Damp	NSF Food Zone
	G5	25	93155905	LED25BDT5/G4/850/CVG	120-277	20	46	3400	5000K	80	50,000	>0.9	S-8STF01	Damp	NSF Food Zone

## 120-347V Ballast Bypass Glass Tubes - Double Ended - Type B - T5

Bulb Shape	Base Type	Watts	Order Code	Description	Volts	Carton Qty <sup>2</sup>	MOL (in)	Lumens (Initial)	Color Temp. (Initial)	CRI	Rated Life L70 (Hrs) <sup>1</sup>	Power Factor	DLC ID <sup>4</sup>	Location Rating <sup>3</sup>	Additional Information
<b>120-347V Ballast Bypass - 4ft T5 HO Glass Tubes</b>															
T5	G5	25	93305599	LED25BDT5/G4/835/120-347	120-347	25	46	3400	3500K	80	50,000	>0.9	S-8Q4DEM	Damp	
	G5	25	93305600	LED25BDT5/G4/840/120-347	120-347	25	46	3500	4000K	80	50,000	>0.9	S-HSUIZ9	Damp	
	G5	25	93305601	LED25BDT5/G4/850/120-347	120-347	25	46	3500	5000K	80	50,000	>0.9	S-15AOPF	Damp	

## Type B Tube Misapplication Fuse Kit

Current offers this fuse kit for use in Type B Tube applications for protection against future misapplication of linear fluorescent lamps.

Order Code	Description	Kit Contents
39017	BT8-1AFUSEKIT	1 Fuse (1A), 1 Fuse Holder

<sup>1</sup> The life rating is based on the hours of operation the lamp will provide before reaching 70% of its original lumen output (L70)

<sup>2</sup> Minimum order quantity = Carton Qty

<sup>3</sup> UL 1993 Environmental Requirements for LED LAMPS

Damp Location - Exterior or interior location that is normally or periodically subject to condensation of moisture in, on, or adjacent to electrical equipment, including partially protected locations

<sup>4</sup> Not all product variations on this page are DLC qualified. Visit [qpl.designlights.org/solid-state-lighting](http://qpl.designlights.org/solid-state-lighting) to confirm qualification.



## Why switch to LED Tubes?

**LED Tubes are the fast and easy way to upgrade from Linear Fluorescent to LED.**

Current offers a variety of LED Tube options, so you can choose the best solution for each application.



No Mercury in LED



50% Energy Reduction



2x Longer Rated Life



Quick Payback

**Fluorescent lamps will soon become unavailable for sale in a number of states with upcoming legislation. Are you ready?**

In an effort to regulate consumer products that contain mercury, state governments within the USA have passed legislation that will prohibit the sale and distribution of Linear and Compact Fluorescent lamps. For more information or to see if your state is impacted, please visit [www.LED.com/lamplegislation](http://www.LED.com/lamplegislation).



# LED Lamps - Tubes - Type C

## LED Tubes - Type C

GE Type C LED Tubes and Drivers are the preferred LED Tube choice for applications that demand dimming, controllability and flexibility.

GE Type C LED Tubes operate from the low voltage DC output of the drivers. The Class 2 output reduces risk of fire and shock compared to higher voltage alternatives. The same lamp may be used with various drivers.

In addition to the lamp-driver combination flexibility, LumenChoice® drivers are field-tunable. Installers can change the output to the lamps using built-in switches on the driver. This allows solutions to be optimized for each application, with potential for more energy savings by reducing the output in overlit spaces.

Dimming and controllability are readily implemented using the 0-10V dimming leads from the drivers. 0-10V dimming was common on dimming ballasts for linear fluorescent lamps, so implementation on existing systems is straightforward. 0-10V output allows for many drivers to be controlled by one device, a practical solution for LED Tube applications. The 0-10V dimming leads from GE Type C LED Tube drivers may also be combined with Current wireless controls. Contact your Current sales representative for more information.

Driver wiring mimics that of instant start ballasts, making for simple installation. Each channel from the driver is independent, so running fewer lamps than the maximum does not impact the other outputs. Running three lamps from a four-lamp driver still provides the same output to each lamp as when four lamps are being operated.

With LumenChoice® Type C LED Tubes and Drivers, fewer SKUs can be used to address the needs of an entire facility. The performance tables in this section show the light output from lamps at each driver wattage setting.

### Catalog Logic:

#### Bulb Shape:

Bulb shape followed by its size (the maximum diameter of the bulb expressed in eighths of an inch).

#### Order Code:

Use the order code when ordering to ensure that you receive the exact product you require

#### Color Rendering Index (CRI or R):

An indication of the ability of the lamp to render object colors in a normal natural way. The higher the number (0-100), the better the color appearance.

**Color Temperature (K):**  
A measure of the visual "warmth" or "coolness" of the light from the lamp. The higher the value, the whiter or "cooler" the light appears.

#### Rated Life L70:

Hours of operation the lamp will provide before reaching 70% of its original lumen output

**MOL (in):**  
Maximum Overall Length in inches

**Carton Quantity:**  
Number of lamps packed in a carton

**Initial Lumens at High Wattage Settings:**  
Lamp lumens at various wattages

**Location Rating:**  
Location Rating as defined for LED Lamps by UL 1993

**2-Lamp Driver:**  
2-Lamp Driver to be used with this lamp corresponding to the wattages in this table

**4-Lamp Driver:**  
4-Lamp Driver to be used with this lamp corresponding to the wattages in this table

Bulb Shape	Base Type	Order Code	Description	Carton Qty <sup>2</sup>	MOL (in)	Color Temp. (Initial)	Color CRI	Rated Life L70 (Hrs) <sup>1</sup>	DLC <sup>3,4</sup>	Location Rating <sup>3</sup>	Initial Lumens at High Wattage Settings:					2-Lamp Driver	4-Lamp Driver* *Max setting is 21W
LumenChoice® 4ft Glass Tubes																	
T8	G13	3421H	LEDT8/LC/G/4/830	20	48	3000K	80	70,000	Yes	Damp	2250	2500	2650	2850	2950	21383 LED/DR/D2L/HW	21392 LED/DR/D4L/HW

## LEDT8/LC/G/4/830

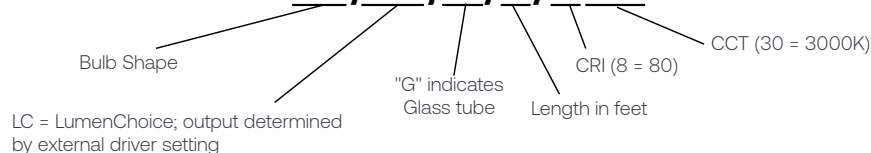

# LED Lamps - Tubes - Type C



## Programming LumenChoice™ Drivers

Before installation, LumenChoice™ Drivers must be set to the desired output. Lumen levels corresponding to the driver settings below are noted in the specification tables. Adjust the switches on the side of the driver to achieve the desired performance according to the table below.

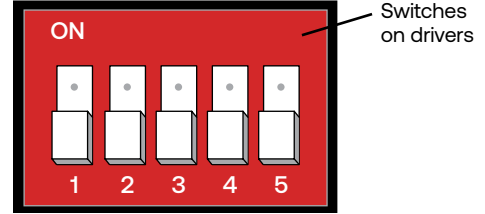

LOW WATTAGE DRIVER DESCRIPTION		DRIVER PRODUCT CODE				
LED/DR/D2L/LW		21378				
SYSTEM WATTS PER LAMP	SWITCH CODE					
	1	2	3	4	5	
16.5						
15						
12						
9						
8						

LOW WATTAGE DRIVER DESCRIPTION		DRIVER PRODUCT CODE				
LED/DR/D4L/LW		21379				
SYSTEM WATTS PER LAMP	SWITCH CODE					
	1	2	3	4	5	
16.5						
15						
12						
9						
8						

HIGH WATTAGE DRIVER DESCRIPTION		DRIVER PRODUCT CODE				
LED/DR/D2L/HW		21383				
SYSTEM WATTS PER LAMP	SWITCH CODE					
	1	2	3	4	5	
25						
23						
21						
19.5						
18						

HIGH WATTAGE DRIVER DESCRIPTION		DRIVER PRODUCT CODE		
LED/DR/D4L/HW		21392		
SYSTEM WATTS PER LAMP	SWITCH CODE			
	1	2	3	
21				
19.5				
18				

**NOTE:**  
THREE SWITCHES ON LED/DR/D4L/HW

# LED Lamps - Tubes - Type C



## LumenChoice® T8 Type C LED Tube and Driver System - T8 on High Wattage Drivers

Bulb Shape	Base Type	Order Code	Description	Carton Qty <sup>2</sup>	MOL (in)	Color Temp. (Initial)	CRI	Rated Life L70 (Hrs) <sup>1</sup>	DLC <sup>4</sup> ID <sup>4</sup>	Location Rating <sup>3</sup>	Initial Lumens at High Wattage Settings:					2-Lamp Driver	4-Lamp Driver* *Max setting is 21W
											18W	19.5W	21W	23W*	25W*		
<b>LumenChoice® 4ft T8 Glass Tubes</b>																	
T8	G13	3421H	LEDT8/LC/G/4/830	20	48	3000K	80	70,000	PSR166LL/PM4YRS96	Damp	2250	2500	2650	2850	2950	21383 LED/DR/D2L/HW	21392 LED/DR/D4L/HW
	G13	3422T	LEDT8/LC/G/4/835	20	48	3500K	80	70,000	PWN2BURT/PJDU9X11	Damp	2300	2550	2700	2900	3000	21383 LED/DR/D2L/HW	21392 LED/DR/D4L/HW
	G13	3423S	LEDT8/LC/G/4/840	20	48	4000K	80	70,000	PS9SSR7Z/PFUM43BU	Damp	2300	2550	2700	2900	3000	21383 LED/DR/D2L/HW	21392 LED/DR/D4L/HW
	G13	34239	LEDT8/LC/G/4/850	20	48	5000K	80	70,000	P21CODHU/PT5ZSP9V	Damp	2300	2550	2700	2900	3000	21383 LED/DR/D2L/HW	21392 LED/DR/D4L/HW

## LumenChoice® T8 Type C LED Tube and Driver System - T8 on Low Wattage Drivers

Bulb Shape	Base Type	Order Code	Description	Carton Qty <sup>2</sup>	MOL (in)	Color Temp. (Initial)	CRI	Rated Life L70 (Hrs) <sup>1</sup>	DLC <sup>4</sup> ID <sup>4</sup>	Location Rating <sup>3</sup>	Initial Lumens at Low Wattage Settings:					2-Lamp Driver	4-Lamp Driver
											8W	9W	12W	15W	16.5W		
<b>LumenChoice® 4 ft T8 XL Glass Tubes</b>																	
T8	G13	93314798	LEDT8/LC/G/4/835XL	20	48	3000K	80	70,000	-	Damp	1150	1450	1850	2250	2350	21378 LED/DR/D2L/LW	21379 LED/DR/D4L/LW
	G13	93314800	LEDT8/LC/G/4/840XL	20	48	3500K	80	70,000	-	Damp	1200	1500	1900	2300	2400	21378 LED/DR/D2L/LW	21379 LED/DR/D4L/LW
	G13	93314802	LEDT8/LC/G/4/850XL	20	48	4000K	80	70,000	-	Damp	1200	1500	1900	2300	2400	21378 LED/DR/D2L/LW	21379 LED/DR/D4L/LW
<b>LumenChoice® 4ft T8 Glass Tubes</b>																	
T8	G13	3421H	LEDT8/LC/G/4/830	20	48	3000K	80	70,000	P0138IQ3/PAY71VOU	Damp	1050	1150	1550	1900	2000	21378 LED/DR/D2L/LW	21379 LED/DR/D4L/LW
	G13	3422T	LEDT8/LC/G/4/835	20	48	3500K	80	70,000	P4WVWYGOA/PRIHTZPW	Damp	1050	1200	1600	1950	2050	21378 LED/DR/D2L/LW	21379 LED/DR/D4L/LW
	G13	3423S	LEDT8/LC/G/4/840	20	48	4000K	80	70,000	PHSUA5K1/PZEDYTZJ	Damp	1050	1200	1600	1950	2050	21378 LED/DR/D2L/LW	21379 LED/DR/D4L/LW
	G13	34239	LEDT8/LC/G/4/850	20	48	5000K	80	70,000	PSZ6O5M1/PMN7ZV5W	Damp	1050	1200	1600	1950	2050	21378 LED/DR/D2L/LW	21379 LED/DR/D4L/LW
<b>LumenChoice® 3ft T8 Glass Tubes</b>																	
T8	G13	36394	LEDT8/LC/G/3/830	20	36	3000K	80	70,000	P9293YKC	Damp	1050	1150	1550	1900	2050	21378 LED/DR/D2L/LW	21379 LED/DR/D4L/LW
	G13	36395	LEDT8/LC/G/3/835	20	36	3500K	80	70,000	PE38VSYF	Damp	1050	1200	1600	1950	2100	21378 LED/DR/D2L/LW	21379 LED/DR/D4L/LW
	G13	36398	LEDT8/LC/G/3/840	20	36	4000K	80	70,000	PNQOE11	Damp	1050	1200	1600	1950	2100	21378 LED/DR/D2L/LW	21379 LED/DR/D4L/LW
	G13	36401	LEDT8/LC/G/3/850	20	36	5000K	80	70,000	P1SRFH1	Damp	1050	1200	1600	1950	2100	21378 LED/DR/D2L/LW	21379 LED/DR/D4L/LW
<b>LumenChoice® 2ft T8 Glass Tubes</b>																	
T8	G13	36406	LEDT8/LC/G/2/830	20	24	3000K	80	70,000	-	Damp	1000	1100	1450			21378 LED/DR/D2L/LW	21379 LED/DR/D4L/LW
	G13	36408	LEDT8/LC/G/2/835	20	24	3500K	80	70,000	PDNPT2AJ	Damp	1050	1200	1550			21378 LED/DR/D2L/LW	21379 LED/DR/D4L/LW
	G13	36409	LEDT8/LC/G/2/840	20	24	4000K	80	70,000	PD3Q3TWL	Damp	1050	1200	1550			21378 LED/DR/D2L/LW	21379 LED/DR/D4L/LW
	G13	36413	LEDT8/LC/G/2/850	20	24	5000K	80	70,000	PRKG3AR4	Damp	1050	1200	1550			21378 LED/DR/D2L/LW	21379 LED/DR/D4L/LW
<b>LumenChoice® U1 T8 Glass Tubes - 1*5/8" leg spacing</b>																	
T8-U1	2G13	28084	LED14T8/U/835	15	22.5	3500K	80	50,000	-	Damp	950	1100	1550			21378 LED/DR/D2L/LW	21379 LED/DR/D4L/LW
	2G13	28164	LED14T8/U/840	15	22.5	4000K	80	50,000	-	Damp	950	1100	1550			21378 LED/DR/D2L/LW	21379 LED/DR/D4L/LW
<b>LumenChoice® U6 T8 Glass Tubes - 6" leg spacing</b>																	
T8-U6	2G13	43131	LED15T8/G/U6/830	12	22.5	3000K	80	50,000	-	Damp	950	1050	1450	1700		21378 LED/DR/D2L/LW	21379 LED/DR/D4L/LW
	2G13	43135	LED15T8/G/U6/835	12	22.5	3500K	80	50,000	-	Damp	1000	1100	1550	1800		21378 LED/DR/D2L/LW	21379 LED/DR/D4L/LW
	2G13	43143	LED15T8/G/U6/840	12	22.5	4000K	80	50,000	-	Damp	1000	1100	1550	1800		21378 LED/DR/D2L/LW	21379 LED/DR/D4L/LW
	2G13	43145	LED15T8/G/U6/850	12	22.5	5000K	80	50,000	-	Damp	1000	1100	1550	1800		21378 LED/DR/D2L/LW	21379 LED/DR/D4L/LW

## 8ft T8 Type C LED Tube and Driver System - T8 on 36W Driver

Bulb Shape	Base Type	Order Code	Description	Carton Qty <sup>2</sup>	MOL (in)	Color Temp. (Initial)	CRI	Rated Life L70 (Hrs) <sup>1</sup>	DLC <sup>4</sup> ID <sup>4</sup>	Location Rating <sup>3</sup>	Input Watts per Lamp	Lumens (Initial)	2-Lamp Driver
T8	Fa8	62327	LED36T8/G/8/835	20	96	3500K	80	50,000	PZEBFURM	Damp	36	4400	63126 LED36T8/DR/D2L
	Fa8	62329	LED36T8/G/8/840	20	96	4000K	80	50,000	P2MIT03H	Damp	36	4400	63126 LED36T8/DR/D2L
	Fa8	62349	LED36T8/G/8/850	20	96	5000K	80	50,000	P1U8ZD2E	Damp	36	4400	63126 LED36T8/DR/D2L

## Remote Drivers for Type C LED Tubes

Input Watts (Max.)	Order Code	Description	Input Voltage	Carton Qty <sup>2</sup>	Length (in)	Width (in)	Height (in)	Freq. (Hz)	Power Factor	Output Voltage	Max. Output Current (A)	Min. Temp. <sup>1</sup>	Max Temp.	0-10V Dimmable	Default Wattage per Tube Setting	Additional Information
33	21378	LED/DR/D2L/LW	120-277 VAC	10	9.5	1.3	1.2	60	>0.9	26-34 VDC	0.48x2	-4° F	104° F	Yes	12W	Max. 2 Tubes; Class 2 Output
66	21379	LED/DR/D4L/LW	120-277 VAC	10	9.5	1.7	1.2	60	>0.9	26-34 VDC	0.48x4	-4° F	104° F	Yes	12W	Max. 4 Tubes; Class 2 Output
50	21383	LED/DR/D2L/HW	120-277 VAC	10	9.5	1.3	1.2	60	>0.9	26-34 VDC	0.72x2	-4° F	104° F	Yes	21W	Max. 2 Tubes; Class 2 Output
84	21392	LED/DR/D4L/HW	120-277 VAC	10	9.5	1.7	1.2	60	>0.9	26-34 VDC	0.62x4	-4° F	104° F	Yes	21W	Max. 4 Tubes; Class 2 Output
<b>120-347V LumenChoice® Remote Drivers - Selectable Output for Type C LED Tubes</b>																
36	93313132	LED/6-18/DR/D2L	120-347 VAC	10	9.5	1.3	1.2	60	>0.9	26-34 VDC	0.53x2	-4° F	104° F	Yes	12W	Max. 2 Tubes; Class 2 Output
72	93313181	LED/6-18/DR/D4L	120-347 VAC	10	9.5	1.7	1.2	60	>0.9	26-34 VDC	0.53x4	-4° F	104° F	Yes	12W	Max. 4 Tubes; Class 2 Output
<b>Fixed Wattage Remote Drivers for Type C LED Tubes</b>																
72	63126	LED36T8/DR/D2L	120-277 VAC	10	9.5	1.7	1.2	60	>0.9	26-34 VDC	1.06x2	-4° F	104° F	Yes	36W <sup>^</sup>	Max. 2 Tubes; Class 2 Output
100	93136147	LED25T/DR/D4L	120-277 VAC	10	16.7	1.7	1.2	60	>0.9	26-34 VDC	0.72x4	-4° F	104° F	Yes	25W <sup>^</sup>	Max. 4 Tubes; LED Class 2 Output

<sup>1</sup> The life rating is based on the hours of operation the lamp will provide before reaching 70% of its original lumen output (L70)

<sup>2</sup> Minimum order quantity - Carton Qty

<sup>3</sup> UL 1993 Environmental Requirements for LED LAMPS

Damp Location - Exterior or interior location that is normally or periodically subject to condensation of moisture in, on, or adjacent to electrical equipment, including partially protected locations

<sup>4</sup> Not all product variations on this page are DLC qualified. Visit [qpl.designlights.org/solid-state-lighting](http://qpl.designlights.org/solid-state-lighting) to confirm qualification.

<sup>^</sup> Fixed Wattage Driver - no wattage adjustment

# LED Lamps - Tubes - Type C



## LumenChoice® T5 Type C LED Tube and Driver System - T5 on High Wattage Drivers

Bulb Shape	Base Type	Order Code	Description	Carton Qty <sup>2</sup>	MOL (in)	Color Temp. (Initial)	CRI	Rated Life L70 (Hrs) <sup>1</sup>	DLC <sup>3</sup> ID <sup>4</sup>	Location Rating <sup>3</sup>	Initial Lumens at High Wattage Settings:					2-Lamp Driver	4-Lamp Driver* *Max setting is 21W
											18W	19.5W	21W	23W*	25W*		
<b>LumenChoice® 4ft T5 Glass Tubes</b>																	
T5	G5	38926	LEDT5/LC/G/4/830	20	46	3000K	80	50,000	-	Damp	2350	2500	2650	2850	3050	21383 LED/DR/D2L/HW	21392 LED/DR/D4L/HW
	G5	38934	LEDT5/LC/G/4/835	20	46	3500K	80	50,000	-	Damp	2400	2550	2750	2950	3150	21383 LED/DR/D2L/HW	21392 LED/DR/D4L/HW
	G5	38940	LEDT5/LC/G/4/840	20	46	4000K	80	50,000	-	Damp	2450	2600	2850	3050	3250	21383 LED/DR/D2L/HW	21392 LED/DR/D4L/HW
	G5	38946	LEDT5/LC/G/4/850	20	46	5000K	80	50,000	-	Damp	2450	2600	2850	3050	3250	21383 LED/DR/D2L/HW	21392 LED/DR/D4L/HW
<b>LumenChoice® 3ft T5 Glass Tubes</b>																	
T5	G5	38947	LEDT5/LC/G/3/830	20	34	3000K	80	50,000	-	Damp	2300	2450	2600	2800	3000	21383 LED/DR/D2L/HW	21392 LED/DR/D4L/HW
	G5	38948	LEDT5/LC/G/3/835	20	34	3500K	80	50,000	-	Damp	2350	2500	2700	2900	3100	21383 LED/DR/D2L/HW	21392 LED/DR/D4L/HW
	G5	38949	LEDT5/LC/G/3/840	20	34	4000K	80	50,000	-	Damp	2400	2550	2800	3000	3200	21383 LED/DR/D2L/HW	21392 LED/DR/D4L/HW
	G5	38955	LEDT5/LC/G/3/850	20	34	5000K	80	50,000	-	Damp	2400	2550	2800	3000	3200	21383 LED/DR/D2L/HW	21392 LED/DR/D4L/HW

## LumenChoice® T5 Type C LED Tube and Driver System - T5 on Low Wattage Drivers

Bulb Shape	Base Type	Order Code	Description	Carton Qty <sup>2</sup>	MOL (in)	Color Temp. (Initial)	CRI	Rated Life L70 (Hrs) <sup>1</sup>	DLC <sup>3</sup> ID <sup>4</sup>	Location Rating <sup>3</sup>	Initial Lumens at Low Wattage Settings:					2-Lamp Driver	4-Lamp Driver
											8W	9W	12W	15W	16.5W		
<b>LumenChoice® 4ft T5 XL Glass Tubes</b>																	
T5	G5	93314792	LEDT5/LC/G/4/835XL	20	46	3500K	80	70,000	-	Damp	1400	1700	2150	2650	2800	21378 LED/DR/D2L/LW	21379 LED/DR/D4L/LW
	G5	93314794	LEDT5/LC/G/4/840XL	20	46	4000K	80	70,000	-	Damp	1450	1750	2200	2700	2850	21378 LED/DR/D2L/LW	21379 LED/DR/D4L/LW
	G5	93314796	LEDT5/LC/G/4/850XL	20	46	5000K	80	70,000	-	Damp	1450	1750	2200	2700	2850	21378 LED/DR/D2L/LW	21379 LED/DR/D4L/LW
<b>LumenChoice® 4ft T5 HE Glass Tubes</b>																	
T5	G5	38995	LEDT5/LC/G/4/835HE	20	46	3500K	80	70,000	-	Damp	1150	1250	1650	1950	2150	21378 LED/DR/D2L/LW	21379 LED/DR/D4L/LW
	G5	38998	LEDT5/LC/G/4/840HE	20	46	4000K	80	70,000	-	Damp	1200	1300	1700	2000	2200	21378 LED/DR/D2L/LW	21379 LED/DR/D4L/LW
	G5	38999	LEDT5/LC/G/4/850HE	20	46	5000K	80	70,000	-	Damp	1200	1300	1700	2000	2200	21378 LED/DR/D2L/LW	21379 LED/DR/D4L/LW
<b>LumenChoice® 3ft T5 HE Glass Tubes</b>																	
T5	G5	39001	LEDT5/LC/G/3/835HE	20	34	3500K	80	70,000	-	Damp	1150	1250	1600	1950	2150	21378 LED/DR/D2L/LW	21379 LED/DR/D4L/LW
	G5	39002	LEDT5/LC/G/3/840HE	20	34	4000K	80	70,000	-	Damp	1200	1300	1650	2000	2200	21378 LED/DR/D2L/LW	21379 LED/DR/D4L/LW
	G5	39003	LEDT5/LC/G/3/850HE	20	34	5000K	80	70,000	-	Damp	1200	1300	1650	2000	2200	21378 LED/DR/D2L/LW	21379 LED/DR/D4L/LW
<b>LumenChoice® 2ft T5 Glass Tubes</b>																	
T5	G5	38968	LEDT5/LC/G/2/830	20	22	3000K	80	70,000	-	Damp	1000	1200	1550	1800	2000	21378 LED/DR/D2L/LW	21379 LED/DR/D4L/LW
	G5	38980	LEDT5/LC/G/2/835	20	22	3500K	80	70,000	-	Damp	1050	1200	1600	1850	2050	21378 LED/DR/D2L/LW	21379 LED/DR/D4L/LW
	G5	38983	LEDT5/LC/G/2/840	20	22	4000K	80	70,000	-	Damp	1100	1250	1650	1900	2100	21378 LED/DR/D2L/LW	21379 LED/DR/D4L/LW
	G5	38992	LEDT5/LC/G/2/850	20	22	5000K	80	70,000	-	Damp	1100	1250	1650	1900	2100	21378 LED/DR/D2L/LW	21379 LED/DR/D4L/LW

## 4ft T5 Type C LED Tube and Driver System - T5 on 25W Driver

Bulb Shape	Base Type	Order Code	Description	Carton Qty <sup>2</sup>	MOL (in)	Color Temp. (Initial)	CRI	Rated Life L70 (Hrs) <sup>1</sup>	DLC <sup>3</sup> ID <sup>4</sup>	Location Rating <sup>3</sup>	Input Watts per Lamp	Lumens (Initial)	4-Lamp Driver
<b>LumenChoice® 4ft T5 Glass Tubes</b>													
T5	G5	38926	LEDT5/LC/G/4/830	20	46	3000K	80	50,000	S-6PMWAG	Damp	25	3050	93136147 LED25T/DR/D4L
	G5	38934	LEDT5/LC/G/4/835	20	46	3500K	80	50,000	S-AOB1TF	Damp	25	3150	93136147 LED25T/DR/D4L
	G5	38940	LEDT5/LC/G/4/840	20	46	4000K	80	50,000	S-SBR6H9	Damp	25	3250	93136147 LED25T/DR/D4L
	G5	38946	LEDT5/LC/G/4/850	20	46	5000K	80	50,000	S-3QCBFR	Damp	25	3250	93136147 LED25T/DR/D4L

## 4ft T5 Type C LED Tube and Driver System - T5 on 36W Driver

Bulb Shape	Base Type	Order Code	Description	Carton Qty <sup>2</sup>	MOL (in)	Color Temp. (Initial)	CRI	Rated Life L70 (Hrs) <sup>1</sup>	DLC <sup>3</sup> ID <sup>4</sup>	Location Rating <sup>3</sup>	Input Watts per Lamp	Lumens (Initial)	2-Lamp Driver
<b>LumenChoice® 4ft T5 Glass Tubes</b>													
T5	G5	38926	LEDT5/LC/G/4/830	20	46	3000K	80	50,000	PZ65QG10	Damp	36	4300	63126 LED36T8/DR/D2L
	G5	38934	LEDT5/LC/G/4/835	20	46	3500K	80	50,000	PTKZGZ6H	Damp	36	4350	63126 LED36T8/DR/D2L
	G5	38940	LEDT5/LC/G/4/840	20	46	4000K	80	50,000	PLE4IIM	Damp	36	4400	63126 LED36T8/DR/D2L
	G5	38946	LEDT5/LC/G/4/850	20	46	5000K	80	50,000	PQP7QK68	Damp	36	4400	63126 LED36T8/DR/D2L

## Remote Drivers for Type C LED Tubes

Input Watts (Max.)	Order Code	Description	Input Voltage	Carton Qty <sup>2</sup>	Length (in)	Width (in)	Height (in)	Freq. (Hz)	Power Factor	Output Voltage	Max. Output Current (A)	Min. Temp. <sup>1</sup>	Max. Temp.	0-10V Dimmable	Default Wattage per Tube Setting	Additional Information
<b>LumenChoice® Remote Drivers - Selectable Output for Type C LED Tubes</b>																
33	21378	LED/DR/D2L/LW	120-277 VAC	10	9.5	1.3	1.2	60	>0.9	26-34 VDC	0.48x2	-4° F	104° F	Yes	12W	Max. 2 Tubes; Class 2 Output
66	21379	LED/DR/D4L/LW	120-277 VAC	10	9.5	1.7	1.2	60	>0.9	26-34 VDC	0.48x4	-4° F	104° F	Yes	12W	Max. 4 Tubes; Class 2 Output
50	21383	LED/DR/D2L/HW	120-277 VAC	10	9.5	1.3	1.2	60	>0.9	26-34 VDC	0.72x2	-4° F	104° F	Yes	21W	Max. 2 Tubes; Class 2 Output
84	21392	LED/DR/D4L/HW	120-277 VAC	10	9.5	1.7	1.2	60	>0.9	26-34 VDC	0.62x4	-4° F	104° F	Yes	21W	Max. 4 Tubes; Class 2 Output
<b>120-347V LumenChoice® Remote Drivers - Selectable Output for Type C LED Tubes</b>																
36	93313132	LED/6-18/DR/D2L	120-347 VAC	10	9.5	1.3	1.2	60	>0.9	26-34 VDC	0.53x2	-4° F	104° F	Yes	12W	Max. 2 Tubes; Class 2 Output
72	93313181	LED/6-18/DR/D4L	120-347 VAC	10	9.5	1.7	1.2	60	>0.9	26-34 VDC	0.53x4	-4° F	104° F	Yes	12W	Max. 4 Tubes; Class 2 Output
<b>Fixed Wattage Remote Drivers for Type C LED Tubes</b>																
72	63126	LED36T8/DR/D2L	120-277 VAC	10	9.5	1.7	1.2	60	>0.9	26-34 VDC	1.06x2	-4° F	104° F	Yes	36W <sup>^</sup>	Max. 2 Tubes; Class 2 Output
100	93136147	LED25T/DR/D4L	120-277 VAC	10	16.7	1.7	1.2	60	>0.9	26-34 VDC	0.72x4	-4° F	104° F	Yes	25W <sup>^</sup>	Max. 4 Tubes; LED Class 2 Output

<sup>1</sup> The life rating is based on the hours of operation the lamp will provide before reaching 70% of its original lumen output (L70)

<sup>2</sup> Minimum order quantity - Carton Qty

<sup>3</sup> UL 1993 Environmental Requirements for LED LAMPS

<sup>4</sup> Damp Location - Exterior or interior location that is normally or periodically subject to condensation of moisture in, on, or adjacent to electrical equipment, including partially protected locations

<sup>^</sup> Not all product variations on this page are DLC qualified. Visit [qpl.designlights.org/solid-state-lighting](http://qpl.designlights.org/solid-state-lighting) to confirm qualification.



# LED Lamps - HID



# LED Lamps - HID



GE LED lamps for HID replacement utilize a proprietary design with active cooling, which allows for high output from a compact size. The length and diameter match HID ANSI profiles. These lamps feature omnidirectional light output, with similar distribution to traditional HID lamps. This enables GE LED lamps to fit in a variety of fixtures while providing equivalent light levels to HID. All of the GE LED lamps in this category are Type B, which means the fixture is re-wired to bypass the ballast.

## Lamp Drawings (not drawn to scale)

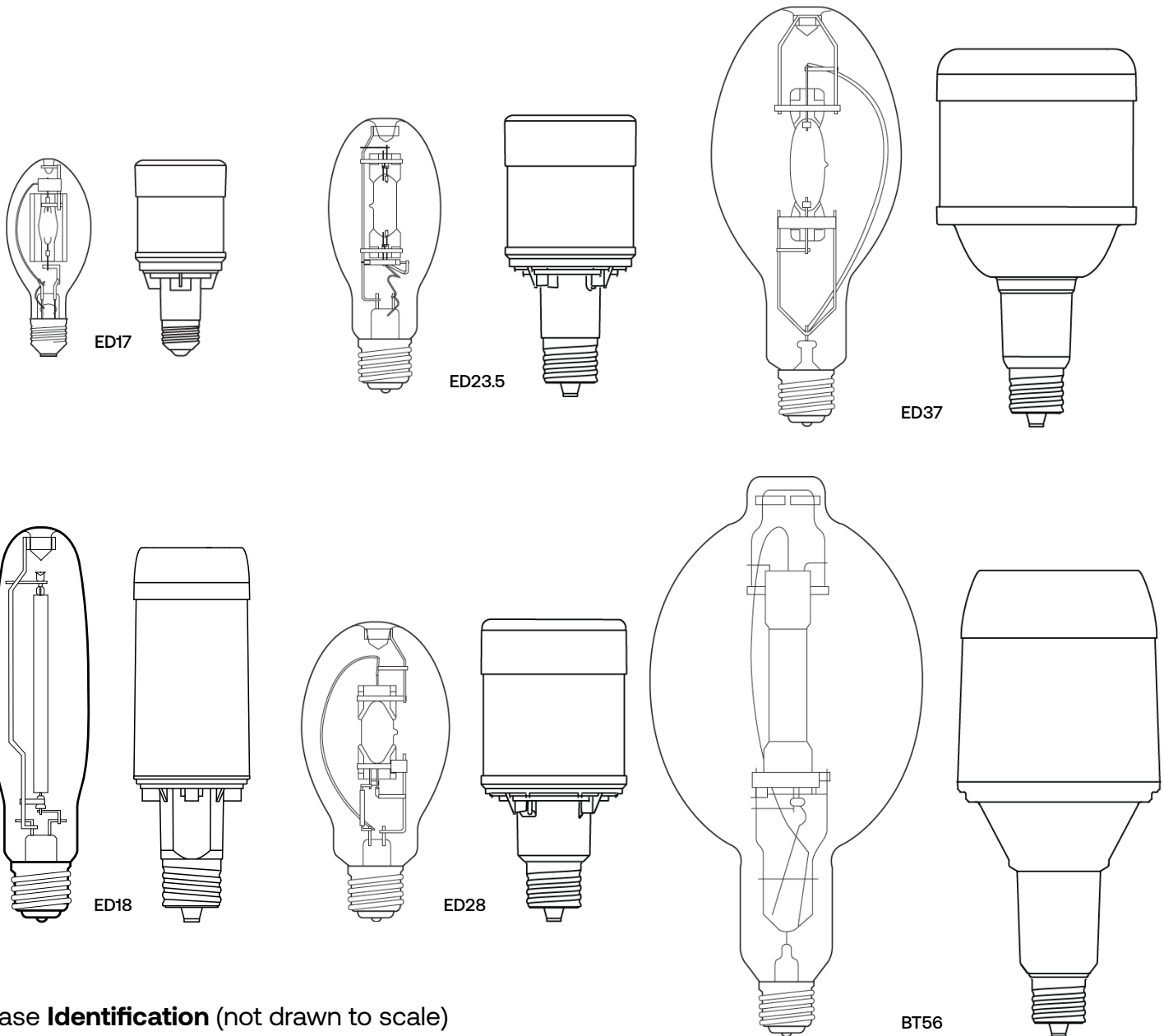

## Base Identification (not drawn to scale)



# LED Lamps - HID



## LED Lamps - HID Portfolio Snapshot



Profile		ED17			ED23.5		ED28		ED18	ED37	BT56		
Base		E26/EX39 Adapter			E26/EX39 Adapter EX39		EX39		EX39	EX39	EX39		
Standard LED HID Lamps	Voltage	120-277 120-347			120-277 277-480		120-277 277-480		120-277	277-480	120-277 277-480	208-277 277-480	277-480
	Color Temp.	3000K, 4000K, 5000K			3000K, 4000K, 5000K		3000K, 4000K, 5000K		3000K, 4000K, 5000K	4000K or 5000K	4000K or 5000K		
	Wattage	21W	35W	45W	50W	80W	115W	150W	180W	360W	270W	450W	470W
	Lumens	3,000	5,000	7,000	7,500	12,000	18,000	23,500	30,000	53,000	40,000	65,000	85,000
	NEMA MH Equivalent	70W	100W	175W	150W	250W	350W	400W	400W	750W	400W	1000W	1000W
NEMA HPS Equivalent	50W	70W	100W	100W	150W	250W	310W	400W	600W	400W	750W	1000W	
Selectable LED HID Lamps*		LumenChoice+ SpectraChoice™			LumenChoice+ SpectraChoice™		LumenChoice+ SpectraChoice™			LumenChoice®			
HazLoc Offering**		21W	35W	45W	80W		150W						

\*Please refer to page 34 for more details about Selectable LED HID Lamps

\*\*Please refer to page 40 for more details about Hazardous Location LED HID Lamps

## Catalog Logic:

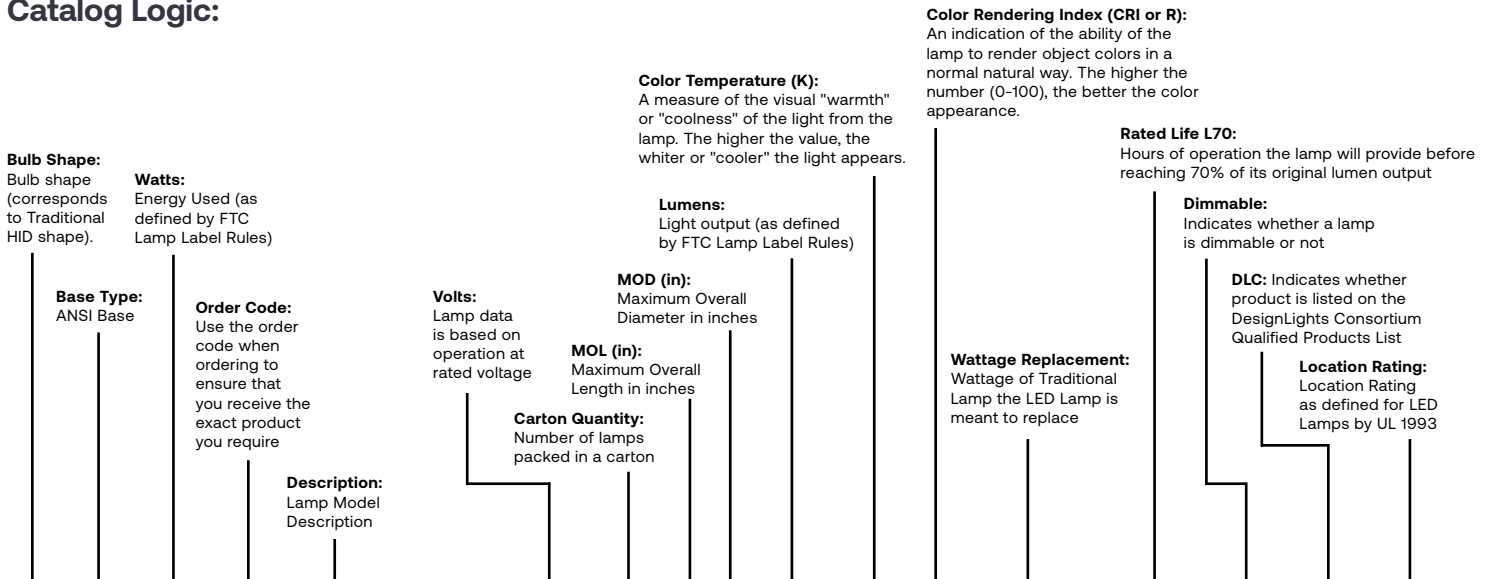

Bulb Shape	Base Type	Watts	Order Code	Description	Volts	Carton Qty <sup>2</sup>	MOL (in)	MOD (in)	Lumens (Initial)	Color Temp. (Initial)	CRI	Wattage Replacement	Rated Life L70 (Hrs) <sup>1</sup>	Dimmable	DLC <sup>3,4</sup>	Location Rating <sup>5,6</sup>
LED Replacement Lamps for HID - Ballast Bypass (Type B) - Hazardous Locations																
ED17	E26/EX39	21	93134832	LED21ED17/730/HAZ	120-277	3	5.4	2.6	3,000	3000K	>70	50W HPS / 70W MH	50,000	-	-	Damp

## LED21ED17/730/HAZ

Wattage      Bulb Shape      CRI (7 = 70)      CCT (30 = 3000K)      Hazardous Locations



## NEMA LED HID Wattage Equivalency

In February of 2021, the National Electrical Manufacturers Association (NEMA) published NEMA LL 10-2020 *Replacing HID Lamps with LED Lamps: Light Output Equivalency Claims*. Current uses this Standard for LED products replacing HID lamps, meeting or exceeding the minimum LED light output for equivalency claims. The LED wattage equivalency varies based on the type of HID lamp being replaced – Metal Halide (MH) or High Pressure Sodium (HPS).

Metal Halide Lamp Wattage (W)	Metal Halide Initial Light Output (lm)	Minimum LED Lamp Initial Light Output (lm)	Current LED Ordinary Location Retrofit Lamps Active Cooling	Current LED Selectable Ordinary Location Retrofit Lamps Active Cooling	Current LED Selectable Ordinary Location Retrofit Lamps Passive Cooling	Current LED Hazardous Location Retrofit Lamps Active Cooling
50	3,200	2,000	LED21ED17	LED/LC/ED17		LED21ED17/HAZ
70	5,200	3,000	LED21ED17	LED/LC/ED17		LED21ED17/HAZ
100	8,100	5,000	LED35ED17; LED45ED17	LED/LC/ED17		LED35ED17/HAZ; LED45ED17/HAZ
150	12,000	7,500	LED50ED23.5	LED/LC/ED23.5	LED/LC/ED23.5P	
175	11,000	7,000	LED45ED17; LED50ED23.5	LED/LC/ED17; LED/LC/ED23.5	LED/LC/ED23.5P	
250	19,100	12,000	LED80ED23.5	LED/LC/ED23.5		LED80ED23.5/HAZ
320	25,600	16,500	LED115ED28	LED/LC/ED28		
350	28,400	18,000	LED115ED28	LED/LC/ED28		
360	29,400	19,000	LED150ED28	LED/LC/ED28		LED150ED28/HAZ
400	33,100	21,500	LED150ED28; LED180ED18	LED/LC/ED28; LED/LC/ED37		LED150ED28/HAZ
750	72,300	46,500	LED360ED37	LED/LC/ED37		
1,000	100,280	65,000	LED450BT56; LED470BT56	LED/LC/ED37		

HPS Lamp Wattage (W)	HPS Initial Light Output (lm)	Minimum LED Lamp Initial Light Output (lm)	Current LED Ordinary Location Retrofit Lamps Active Cooling	Current LED Selectable Ordinary Location Retrofit Lamps Active Cooling	Current LED Selectable Ordinary Location Retrofit Lamps Passive Cooling	Current LED Hazardous Location Retrofit Lamps Active Cooling
50	4,500	2,500	LED21ED17	LED/LC/ED17		LED21ED17/HAZ
70	6,300	4,000	LED35ED17	LED/LC/ED17		LED35ED17/HAZ
100	9,500	6,000	LED45ED17; LED50ED23.5	LED/LC/ED17; LED/LC/ED23.5	LED/LC/ED23.5P	LED45ED17/HAZ
150	13,000	8,500	LED80ED23.5	LED/LC/ED23.5		LED80ED23.5/HAZ
200	19,500	12,500		LED/LC/ED23.5		
250	26,000	17,000	LED115ED28	LED/LC/ED28		
310	33,200	21,500	LED150ED28	LED/LC/ED28		LED150ED28/HAZ
400	44,000	29,000	LED180ED18; LED270BT56	LED/LC/ED37		
600	66,000	42,500	LED360ED37	LED/LC/ED37		
750	82,500	53,500	LED450BT56	LED/LC/ED37		
1,000	110,000	73,000	LED470BT56			

# LED Lamps - HID



Current offers unmatched flexibility in a **HID LED Replacement Lamp**. Select wattage and color temperature at the flick of a switch.

LumenChoice® + SpectraChoice™ ED17, ED23.5 and ED28 lamps maximize the potential to reduce inventory and streamline product lists. These lamps allow installers to react to a wide variety of needs, providing the ability to adjust both the color temperature of the light and the brightness. Utilizing proprietary active cooling technology, Selectable LED HID lamps still match the length and diameter of the HID ANSI profile, so size isn't an issue when trying to fit these lamps into existing fixtures.

But what about when it's known a site prefers a specific color temperature? Selectable LumenChoice® ED37 replacement lamps provide a single color temperature SKU with lumen level selectability to ensure that you always have the perfect amount of light for any space at your site.



Select wattage (lumens) using built-in switch.

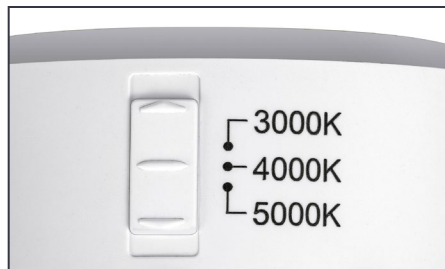

Select color temperature using built-in switch.



### Even more versatility

Each E26 lamp comes with a mogul base adapter. Lamps may be used in E26 or E39/EX39 sockets.

Profile	ED17			ED23.5			ED28			ED37		
Voltage	120-277 120-347			120-277 277-480			120-277 277-480			277-480		
Base	E26/EX39 Adapter			E26/EX39 Adapter EX39			EX39			EX39		
Color Temperature	SpectraChoice™			SpectraChoice™			SpectraChoice™			4000K or 5000K		
	3000K	4000K	5000K	3000K	4000K	5000K	3000K	4000K	5000K			
Wattage	LumenChoice®			LumenChoice®			LumenChoice®			LumenChoice®		
	21W	35W	45W	50W	65W	80W	90W	115W	150W	200W	325W	450W
Lumens	3,000	5,500	7,000	8,200	10,500	12,500	14,000	18,000	23,500	35,000	53,500	68,000
NEMA MH Equivalent	70W	100W	175W	150W	150W	250W	250W	350W	400W	400W	750W	1000W
NEMA HPS Equivalent	50W	70W	100W	100W	150W	150W	200W	250W	310W	400W	750W	750W



## Selectable LumenChoice® + SpectraChoice™ HID Replacement - Type B

Bulb Shape	Base Type	Order Code	Description	Volts	Carton Qty <sup>2</sup>	MOL (in)	MOD (in)	Selectable Watts*	Selectable Lumens (Initial) <sup>7</sup>	Selectable Color Temp.* (Initial)	Wattage Replacement <sup>8</sup>	CRI	Rated Life L70 (Hrs) <sup>1</sup>	DLC <sup>3</sup> ID <sup>3,4</sup>	Location Rating <sup>5,6</sup>
<b>LED Replacement Lamp for HID - Ballast Bypass (Type B)</b>															
ED17	E26/EX39	93303384	LED/LC/ED17/7SC	120-277	3	5.4	2.6	21	3,400	3000K	50W HPS / 70W MH	>70	50,000	-	Damp
								35*	5,500*	4000K*	70W HPS / 100W MH				
ED17	E26/EX39	93314526	LED/LC/ED17/7SC/120-347	120-347	3	5.4	2.6	21	3,400	3000K	50W HPS / 70W MH	>70	50,000	-	Damp
								35*	5,500*	4000K*	70W HPS / 100W MH				
ED23.5	E26/EX39	93312104	LED/LC/ED23.5M/7SC	120-277	3	7.8	3.7	50	8,200	3000K	100W HPS / 150W MH	>70	50,000	-	Damp
								65	10,500	4000K	150W HPS / 150W MH				
ED23.5	EX39	93312106	LED/LC/ED23.5/7SC	120-277	3	7.8	3.7	50	8,200	3000K	100W HPS / 150W MH	>70	50,000	S-4V5NOG	Damp
								65	10,500	4000K	150W HPS / 150W MH				
ED23.5	EX39	93314766	LED/LC/ED23.5/7SC/277-480	277-480	3	7.8	3.7	50	8,200	3000K	100W HPS / 150W MH	>70	50,000	-	Damp
								65	10,500	4000K	150W HPS / 150W MH				
ED28	EX39	93312102	LED/LC/ED28/7SC	120-277	3	8.3	4.1	90	14,000	3000K	200W HPS / 250W MH	>70	50,000	S-MB9GRL / S-NMTK94	Damp
								115	18,000	4000K	250W HPS / 350W MH				
ED28	EX39	93314772	LED/LC/ED28/7SC/277-480	277-480	3	8.3	4.1	90	14,000	3000K	200W HPS / 250W MH	>70	50,000	-	Damp
								115	18,000	4000K	250W HPS / 350W MH				

## Selectable LumenChoice® HID Replacement - Type B

Bulb Shape	Base Type	Order Code	Description	Volts	Carton Qty <sup>2</sup>	MOL (in)	MOD (in)	Selectable Watts*	Selectable Lumens (Initial) <sup>7</sup>	Selectable Color Temp.* (Initial)	Wattage Replacement <sup>8</sup>	CRI	Rated Life L70 (Hrs) <sup>1</sup>	DLC <sup>3</sup> ID <sup>3,4</sup>	Location Rating <sup>5,6</sup>
<b>LED Replacement Lamp for HID - Ballast Bypass (Type B)</b>															
ED37	EX39	93311586	LED/LC/ED37/740	277-480	3	11.3	5.6	200	35,000	4000K	400W HPS / 400W MH	>70	50,000	S-ZZMLJT	Damp
								450*	68,000*	750W HPS / 1000W MH					
ED37	EX39	93311587	LED/LC/ED37/750	277-480	3	11.3	5.6	200	35,000	5000K	400W HPS / 400W MH	>70	50,000	S-25L41Q	Damp
								325	53,500	750W HPS / 750W MH					
								450*	68,000*	750W HPS / 1000W MH					

## Warm Selectable LumenChoice® + SpectraChoice™ HID Replacement - Type B

Bulb Shape	Base Type	Order Code	Description	Volts	Carton Qty <sup>2</sup>	MOL (in)	MOD (in)	Selectable Watts*	Selectable Lumens (Initial) <sup>7</sup>	Selectable Color Temp.* (Initial)	Wattage Replacement <sup>8</sup>	CRI	Rated Life L70 (Hrs) <sup>1</sup>	DLC <sup>3</sup>	Location Rating <sup>5,6</sup>
<b>LED Replacement Lamp for HID - Ballast Bypass (Type B)</b>															
ED17	E26/EX39	93315986	LED/LC/ED17/7WSC/120-347	120-347	3	5.4	2.6		2,450	1800K	35W HPS / 50W MH	>70	50,000	-	Damp
									3,950	2200K	35W HPS / 50W MH				
									4,900	2700K	50W HPS / 50W MH				
									3,000	1800K	35W HPS / 50W MH				
									4,900*	2200K*	50W HPS / 70W MH				
									6,200	2700K	70W HPS / 70W MH				
									3,300	1800K	50W HPS / 70W MH				
									45	5,450	2200K				
		6,650	2700K	70W HPS / 100W MH											

<sup>1</sup> The life rating is based on the hours of operation the lamp will provide before reaching 70% of its original lumen output (L70)

<sup>2</sup> Minimum order quantity = 1

<sup>3</sup> E26 based products are not eligible for DLC. Not all product variations on this page are DLC qualified. Visit [qpl.designlights.org/solid-state-lighting](http://qpl.designlights.org/solid-state-lighting) to confirm qualification.

<sup>4</sup> Do not use with phase-cut dimmers. Dimming functions only with external Variac control devices.

<sup>5</sup> UL 1993 Environmental Requirements for LED LAMPs

Damp Location - Exterior or interior location that is normally or periodically subject to condensation of moisture in, on, or adjacent to electrical equipment, including partially protected locations

<sup>6</sup> Not suitable for air-tight explosive or hazardous fixtures.

<sup>7</sup> Lumen levels correspond with wattage levels. Color temperature levels are independent of wattage & lumens.

<sup>8</sup> Wattage Replacement levels correspond with wattage levels. Wattage Replacements based on NEMA Standards Publication LL 10-2020 *Replacing HID Lamps with LED Lamps: Light Output Equivalency Claims*.

\* Default wattage and color temperature settings noted by "\*" in tables above. Lumen levels correspond with wattage levels. Color temperature levels are independent of wattage & lumens.



Current introduces an Industry-First **400W LED HID Replacement in an ED18 Shape**.

GE LED lamps for HID replacement utilize a proprietary design with active cooling, which allows for high output from a compact size. The length and diameter match HID ANSI profiles. These lamps feature omnidirectional light output, with similar distribution to traditional HID lamps. This enables GE LED lamps to fit in a variety of fixtures while providing equivalent light levels to HID, making it possible to upgrade more applications to LED without replacing an entire fixture. All of the GE LED lamps in this category are Type B, which means the fixture is re-wired to bypass the ballast.

## Lamp Drawings (not drawn to scale)

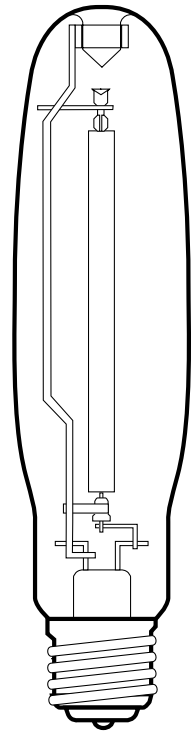

LU400

ED18



LED180

## ED18 HID Replacement - Type B

Bulb Shape	Base Type	Watts	Order Code	Description	Volts	Carton Qty <sup>2</sup>	MOL (in)	MOD (in)	Lumens (Initial)	Color Temp.	CRI	Wattage Replacement <sup>6</sup>	Rated Life L70 (Hrs) <sup>1</sup>	DLC <sup>3</sup> ID <sup>4,5</sup>	Location Rating <sup>5</sup>
<b>LED Replacement Lamp for HID - Ballast Bypass (Type B)</b>															
ED18	EX39	180	93312096	LED180ED18/730	120-277	3	9.7	3.0	30,000	3000K	>70	400W HPS/400W MH	50,000	S-F26H3J	Damp, Enclosed
	EX39	180	93312098	LED180ED18/740	120-277	3	9.7	3.0	30,000	4000K	>70	400W HPS/400W MH	50,000	S-WN2HR8	Damp, Enclosed
	EX39	180	93312100	LED180ED18/750	120-277	3	9.7	3.0	30,000	5000K	>70	400W HPS/400W MH	50,000	S-BG0B87	Damp, Enclosed

These products are covered by U.S. Patents 10788163 and 10508776. These products may also be covered by other U.S. patents or pending applications.

Information provided is subject to change without notice. Please verify all details with Current. All values are design or typical values when measured under laboratory conditions, and Current makes no warranty or guarantee, expressed or implied, that such performance will be obtained under end-use conditions.

<sup>1</sup> The life rating is based on the hours of operation the lamp will provide before reaching 70% of its original lumen output (L70)

<sup>2</sup> Minimum order quantity from Current = 1

<sup>3</sup> UL 1993 Environmental Requirements for LED LAMPS

Damp Location - Exterior or interior location that is normally or periodically subject to condensation of moisture in, on, or adjacent to electrical equipment, including partially protected locations

<sup>4</sup> Not all product variations on this page are DLC qualified. Visit [qpl.designlights.org/solid-state-lighting](http://qpl.designlights.org/solid-state-lighting) to confirm qualification.

<sup>5</sup> Do not use with phase-cut dimmers. Dimming functions only with external Variac control devices.

<sup>6</sup> Wattage Replacements based on NEMA Standards Publication LL 10-2020 *Replacing HID Lamps with LED Lamps: Light Output Equivalency Claims*.

# LED Lamps - HID



## LED HID - Type B

Bulb Shape	Base Type	Watts	Order Code	Description	Volts	Carton Qty <sup>2</sup>	MOL (in)	MOD (in)	Lumens (Initial)	Color Temp. (Initial)	CRI	Wattage Replacement <sup>3</sup>	Rated Life L70 (Hrs) <sup>1</sup>	DLC ID <sup>3,4</sup>	Location Rating <sup>5,6</sup>
<b>LED Replacement Lamps for HID - Ballast Bypass (Type B)</b>															
ED17	E26	21	27729	LED21ED17/740	120-277	3	5.4	2.6	3,000	4000K	>70	50W HPS / 70W MH	50,000	-	Damp
	E26	21	27732	LED21ED17/750	120-277	3	5.4	2.6	3,000	5000K	>70	50W HPS / 70W MH	50,000	-	Damp
	E26	35	93112114	LED35ED17/730	120-277	3	5.4	2.6	5,000	3000K	>70	70W HPS / 100W MH	50,000	-	Damp
	E26	35	27602	LED35ED17/740	120-277	3	5.4	2.6	5,000	4000K	>70	70W HPS / 100W MH	50,000	-	Damp
	E26	35	27724	LED35ED17/750	120-277	3	5.4	2.6	5,000	5000K	>70	70W HPS / 100W MH	50,000	-	Damp
	E26	45	93116975	LED45ED17/835	120-277	3	5.4	2.6	6,000	3500K	>70	100W HPS / 100W MH	50,000	-	Damp
	E26	45	93148082	LED45ED17/740	120-277	3	5.4	2.6	7,000	4000K	>70	100W HPS / 175W MH	50,000	-	Damp
	E26	45	93148081	LED45ED17/750	120-277	3	5.4	2.6	7,000	5000K	>70	100W HPS / 175W MH	50,000	-	Damp
ED23.5	E26	80	22768	LED80ED23.5M/740	120-277	3	7.8	3.7	12,000	4000K	>70	150W HPS / 250W MH	50,000	-	Damp
	E26	80	93125008	LED80ED23.5M/750	120-277	3	7.8	3.7	12,000	5000K	>70	150W HPS / 250W MH	50,000	-	Damp
	EX39	50	22679	LED80ED23.5/740	120-277	3	7.8	3.7	7,500	4000K	>70	100W HPS / 150W MH	50,000	P2LJ433Z	Damp
	EX39	50	22739	LED50ED23.5/750	120-277	3	7.8	3.7	7,500	5000K	>70	100W HPS / 150W MH	50,000	P9E7B4MB	Damp
	EX39	50	93154637	LED50ED23.5/740/277/480	277-480	3	7.8	3.7	7,500	4000K	>70	100W HPS / 150W MH	50,000	S-GSEC3A	Damp
	EX39	50	93154639	LED50ED23.5/750/277/480	277-480	3	7.8	3.7	7,500	5000K	>70	100W HPS / 150W MH	50,000	S-TGNWE4	Damp
	EX39	80	93112196	LED80ED23.5/730	120-277	3	7.8	3.7	12,000	3000K	>70	150W HPS / 250W MH	50,000	PDVKOYIV	Damp
	EX39	80	22635	LED80ED23.5/740	120-277	3	7.8	3.7	12,000	4000K	>70	150W HPS / 250W MH	50,000	PHJ4LA1W	Damp
	EX39	80	22676	LED80ED23.5/750	120-277	3	7.8	3.7	12,000	5000K	>70	150W HPS / 250W MH	50,000	PYL1MPL2	Damp
	EX39	80	93154642	LED80ED23.5/740/277/480	277-480	3	7.8	3.7	12,000	4000K	>70	150W HPS / 250W MH	50,000	S-TUGPZM	Damp
	EX39	80	93154640	LED80ED23.5/750/277/480	277-480	3	7.8	3.7	12,000	5000K	>70	150W HPS / 250W MH	50,000	S-1FJ4CK	Damp
ED28	EX39	115	93112197	LED115ED28/730	120-277	3	8.3	4.1	18,000	3000K	>70	250W HPS / 350W MH	50,000	PE646DNU / S-PJV8RX	Damp
	EX39	115	22622	LED115ED28/740	120-277	3	8.3	4.1	18,000	4000K	>70	250W HPS / 350W MH	50,000	PONSAR2J / S-7Y6F60	Damp
	EX39	115	22623	LED115ED28/750	120-277	3	8.3	4.1	18,000	5000K	>70	250W HPS / 350W MH	50,000	PZFIPZUL / S-VVTYR7	Damp
	EX39	115	93139853	LED115ED28/740/277/480	277-480	3	8.3	4.1	18,000	4000K	>70	250W HPS / 350W MH	50,000	PZ3P5P7U/PEQF29S7	Damp
	EX39	115	93139854	LED115ED28/750/277/480	277-480	3	8.3	4.1	18,000	5000K	>70	250W HPS / 350W MH	50,000	PY31MNAU/PCV74KSL	Damp
	EX39	150	93112198	LED150ED28/730	120-277	3	8.3	4.1	23,500	3000K	>70	310W HPS / 400W MH	50,000	PAVD2DOE	Damp
	EX39	150	22611	LED150ED28/740	120-277	3	8.3	4.1	23,500	4000K	>70	310W HPS / 400W MH	50,000	P53Y3N60	Damp
	EX39	150	22613	LED150ED28/750	120-277	3	8.3	4.1	23,500	5000K	>70	310W HPS / 400W MH	50,000	P1EL9LHG	Damp
	EX39	150	93139849	LED150ED28/740/277/480	277-480	3	8.3	4.1	23,500	4000K	>70	310W HPS / 400W MH	50,000	PUQUH5LU/PYCNNIK7	Damp
	EX39	150	93139850	LED150ED28/750/277/480	277-480	3	8.3	4.1	23,500	5000K	>70	310W HPS / 400W MH	50,000	PY3DUSYO/POTANRAP	Damp
ED18	EX39	180	93312096	LED180ED18/730	120-277	3	9.7	3.0	30,000	3000K	>70	400W HPS/400W MH	50,000	S-F26H3J	Damp, Enclosed
	EX39	180	93312098	LED180ED18/740	120-277	3	9.7	3.0	30,000	4000K	>70	400W HPS/400W MH	50,000	S-WN2HR8	Damp, Enclosed
	EX39	180	93312100	LED180ED18/750	120-277	3	9.7	3.0	30,000	5000K	>70	400W HPS/400W MH	50,000	S-BG0B87	Damp, Enclosed
BT56	EX39	270	93153080	LED270BT56/740/120/277	120-277	3	12.3	5.6	40,000	4000K	>70	400W HPS / 400W MH	50,000	PG8499V4	Damp
	EX39	270	93153121	LED270BT56/750/120/277	120-277	3	12.3	5.6	40,000	5000K	>70	400W HPS / 400W MH	50,000	PIZKSQ30	Damp
	EX39	270	93095547	LED270BT56/740	277-480	3	12.3	5.6	40,000	4000K	>70	400W HPS / 400W MH	50,000	PW00LOQL	Damp
	EX39	270	93095553	LED270BT56/750	277-480	3	12.3	5.6	40,000	5000K	>70	400W HPS / 400W MH	50,000	PUZP8RVI	Damp
ED37	EX39	360	93122144	LED360ED37/740	277-480	3	10.6	5.6	53,000	4000K	>70	600W HPS / 750W MH	50,000	P7WQQT4S	Damp
	EX39	360	93122166	LED360ED37/750	277-480	3	10.6	5.6	53,000	5000K	>70	600W HPS / 750W MH	50,000	PK5HC9UY	Damp
BT56	EX39	450	93153122	LED450BT56/740/208/277	208-277	3	12.3	5.6	65,000	4000K	>70	750W HPS / 1000W MH	50,000	POIL8M4C	Damp
	EX39	450	93153123	LED450BT56/750/208/277	208-277	3	12.3	5.6	65,000	5000K	>70	750W HPS / 1000W MH	50,000	PD4K2UXF	Damp
	EX39	450	93096445	LED450BT56/740	277-480	3	12.3	5.6	65,000	4000K	>70	750W HPS / 1000W MH	50,000	PLNCOZ5Z	Damp
	EX39	450	93096547	LED450BT56/750	277-480	3	12.3	5.6	65,000	5000K	>70	750W HPS / 1000W MH	50,000	PH8F9ZNF	Damp
	EX39	470	93303389	LED470BT56/740	277-480	3	12.8	5.6	85,000	4000K	>70	1000W HPS / 1000W MH	50,000	S-E56HRP	Damp
	EX39	470	93303388	LED470BT56/750	277-480	3	12.8	5.6	85,000	5000K	>70	1000W HPS / 1000W MH	50,000	S-64APZW	Damp

Additional Information for LED Replacement Lamps for HID: Open and Closed Rated - Ballast bypass required  
 These products are covered by U.S. Patents 10788163 and 10508776. These products may also be covered by other U.S. patents or pending applications.

## LED HID Accessories

Order Code	Description	Carton Qty <sup>2</sup>	Additional Information
93151372	LED/E26/EX39/ADAPTER	60	E26/EX39 Socket Adapter
93313551	LED-HID-TETHER-KIT	20	1 Tether Kit
93313553	LED-HID-4A-FUSE-KIT	20	1 Fuse (4A), 1 Fuse Holder
93313555	LED-HID-8A-FUSE-KIT	20	1 Fuse (8A), 1 Fuse Holder

<sup>1</sup> The life rating is based on the hours of operation the lamp will provide before reaching 70% of its original lumen output (L70)

<sup>2</sup> Minimum order quantity = 1

<sup>3</sup> E26 based products are not eligible for DLC. Not all product variations on this page are DLC qualified. Visit [qpl.designlights.org/solid-state-lighting](http://qpl.designlights.org/solid-state-lighting) to confirm qualification.

<sup>4</sup> Do not use with phase-cut dimmers. Dimming functions only with external Variac control devices.

<sup>5</sup> UL 1993 Environmental Requirements for LED LAMPS

<sup>6</sup> Damp Location - Exterior or interior location that is normally or periodically subject to condensation of moisture in, on, or adjacent to electrical equipment, including partially protected locations

<sup>7</sup> Not suitable for air-tight explosive or hazardous fixtures.

<sup>8</sup> Lumen levels correspond with wattage levels. Color temperature levels are independent of wattage & lumens.

<sup>9</sup> Wattage Replacement levels correspond with wattage levels. Wattage Replacements based on NEMA Standards Publication LL 10-2020 *Replacing HID Lamps with LED Lamps: Light Output Equivalency Claims*.

# LED Lamps - HID



Current offers a cost-effective LED Conversion in a **Passive HID LED Replacement Lamp**. Select wattage and color temperature at the flick of a switch.

Current's Passive Selectable ED23.5 LED HID Replacement Lamps offer a cost effective solution for less demanding applications. Upgrade to LED in lower wattage HID applications that use the ED23.5 or ED28 shape (up to a 100W high pressure sodium, up to 175W metal halide), and significantly increase CRI compared to High Pressure Sodium Lamps, from 21 CRI to 70 CRI. The Passive cooling lamps (no fan) have electronic thermal management to gradually reduce the light as ambient temperatures increase.

LumenChoice® + SpectraChoice™ ED23.5 lamps feature built-in switches to easily allow the change of wattage and color temperature, no tools required. One lamp can cover many applications, reducing inventory & simplifying BOMs.



Current's Passive Selectable LED HID Lamps maintain ANSI length and diameter, ensuring that the lamps will fit into fixtures and utilize existing optics. These lamps feature omnidirectional light output, with similar distribution to traditional HID lamps. This enables GE LED lamps to fit in a variety of fixtures while providing equivalent light levels to HID and utilizing the existing optics. All of the GE LED lamps in this category are Type B, which means the fixture is re-wired to bypass the ballast.

## Lamp Comparison

ED23.5 HID Lamp

Active Cooling Selectable ED23.5

Passive Cooling Selectable ED23.5

Other Passive Cooling LED Lamps

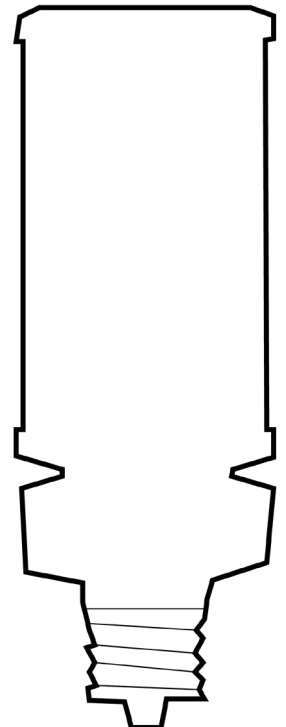
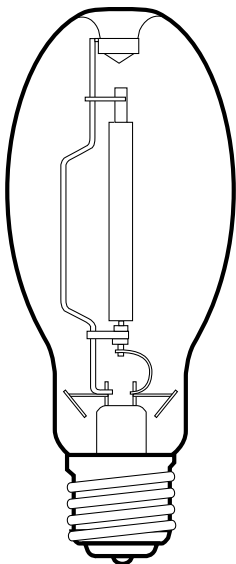

Wattage Levels (W)  
Lumen Levels (lm)  
Color Temp. Levels (K)  
Base Options  
Length (in)  
Diameter (in)

50 / 65 / 80  
8,000 / 10,300 / 12,000  
3000K / 4000K / 5000K  
E26 (with EX39 Adapter) or EX39  
7.8 in  
3.7 in

32 / 39 / 46  
5,000 / 6,300 / 7,500  
3000K / 4000K / 5000K  
EX39  
7.8 in  
3.7 in

36 / 45 / 54  
5,040 / 6,300 / 7,560  
3000K / 4000K / 5000K  
EX39  
9.69 in  
3.35 in

# LED Lamps - HID



Select wattage (lumens) and color temperature using built-in switch



Passive Cooling Selectable ED17



Select wattage (lumens) and color temperature using built-in switch



Passive Cooling Selectable ED23.5



## Passive Selectable LED HID Replacement - Type B

Bulb Shape	Base Type	Order Code	Description	Volts	Carton Qty <sup>2</sup>	MOL (in)	MOD (in)	Selectable Watts	Selectable Lumens (Initial) <sup>7</sup>	Selectable Color Temp.* (Initial)	Wattage Replacement <sup>8</sup>	CRI	Rated Life L70 (Hrs) <sup>1</sup>	DLC <sup>3,4,5</sup>	Location Rating <sup>3</sup>
LED Replacement Lamp for HID - Ballast Bypass (Type B)															
ED17	E26	93316026	LED/LC/ED17P/7SC/120-347	120-347	3	5.6	2.6	13 19 25*	2,300 3,200 4,000*	3000K 4000K* 5000K	35W HPS / 50W MH 50W HPS / 70W MH 70W HPS / 70W MH	>70	50,000	-	Damp, Enclosed
ED23.5	EX39	93314601	LED/LC/ED23.5P/7SC	120-277	3	7.8	3.7	32 39 46*	5,000 6,300 7,500*	3000K 4000K 5000K*	70W HPS / 150W MH 70W HPS / 150W MH 100W HPS / 175W MH	>70	50,000	S-NDF684	Damp, Enclosed

These products are covered by U.S. Patent 10508776. These products may also be covered by other U.S. patents or pending applications.

## Warm Passive Selectable LumenChoice® + SpectraChoice™ HID Replacement - Type B

Bulb Shape	Base Type	Order Code	Description	Volts	Carton Qty <sup>2</sup>	MOL (in)	MOD (in)	Selectable Watts*	Selectable Lumens (Initial) <sup>7</sup>	Selectable Color Temp.* (Initial)	Wattage Replacement <sup>8</sup>	CRI	Rated Life L70 (Hrs) <sup>1</sup>	DLC <sup>3</sup>	Location Rating <sup>5,6</sup>
LED Replacement Lamp for HID - Ballast Bypass (Type B)															
ED17	E26	93318489	LED/LC/ED17P/7WSC/120-347	120-347	3	5.6	2.6	13 19 25*	1,600 2,200 2,800 2,000 2,700 3,400 2,200 3,000* 3,900	1800K 2200K 2700K 1800K 2200K 2700K 1800K 2200K* 2700K	35W HPS / 50W MH 35W HPS / 50W MH 35W HPS / 50W MH 35W HPS / 50W MH 35W HPS / 50W MH 35W HPS / 50W MH 35W HPS / 50W MH 35W HPS / 50W MH 50W HPS / 70W MH	>70	50,000	-	Damp, Enclosed

These products are covered by U.S. Patent 10508776. These products may also be covered by other U.S. patents or pending applications.

Information provided is subject to change without notice. Please verify all details with Current. All values are design or typical values when measured under laboratory conditions, and Current makes no warranty or guarantee, expressed or implied, that such performance will be obtained under end-use conditions.

<sup>1</sup> The life rating is based on the hours of operation the lamp will provide before reaching 70% of its original lumen output (L70)

<sup>2</sup> Minimum order quantity from Current = 1

<sup>3</sup> UL 1993 Environmental Requirements for LED LAMPS

<sup>4</sup> Damp Location - Exterior or interior location that is normally or periodically subject to condensation of moisture in, on, or adjacent to electrical equipment, including partially protected locations

<sup>5</sup> Not all product variations on this page are DLC qualified. Visit [qpl.designlights.org/solid-state-lighting](http://qpl.designlights.org/solid-state-lighting) to confirm qualification.

<sup>6</sup> Do not use with phase-cut dimmers. Use integrated switch for dimming.

<sup>7</sup> Wattage Replacements based on NEMA Standards Publication LL 10-2020 Replacing HID Lamps with LED Lamps: Light Output Equivalency Claims.

<sup>8</sup> \*Default wattage and color temperature settings noted by "\*" in tables above. Lumen levels correspond with wattage levels. Color temperature levels are independent of wattage & lumens.

## HID LED Replacement Lamp Case Studies

470W High Output BT56 LED Replacement lamps were used to retrofit 1500W Metal Halide fixtures at a baseball field in Riverview, New Brunswick, Canada. For more details around the retrofit and the resulting benefits that they realized, visit [www.LED.com/inspiration/ballfield-benefits-from-new-high-output-led-lamp](http://www.LED.com/inspiration/ballfield-benefits-from-new-high-output-led-lamp).



Drone images capture the before and after of the baseball field highlighting the uniform light coverage after the LED BT56 installation.



## HID LED Replacement Lamp Case Studies

Improvements in lighting can make a huge impact on the safety and security of a site. In the example below, 250W Metal Halide HID Lamps were replaced with 80W Type B ED23.5 LED HID Lamps, resulting in a noticeable improvement in visibility and light coverage.

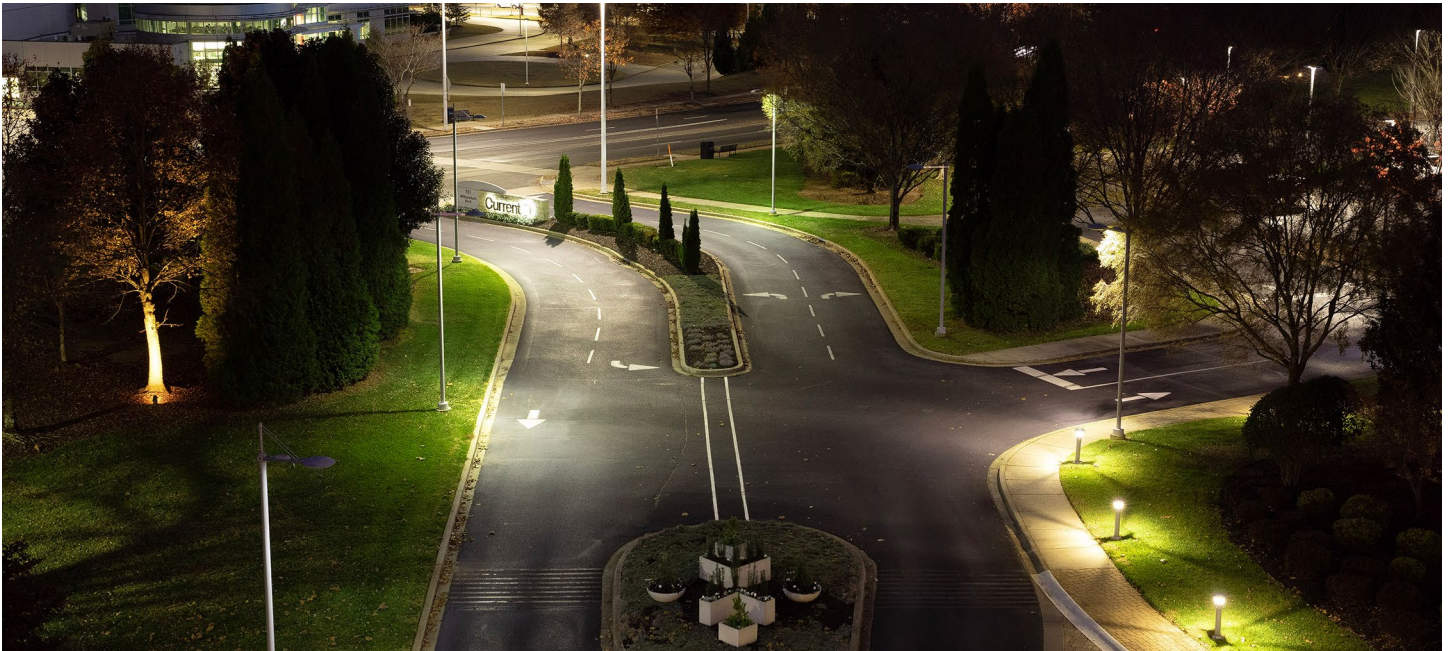

Before: 250W Metal Halide Lamps



After: 80W ED23.5 LED HID Lamps

# LED Lamps - HID - Hazardous Locations



## LED Lamps – HID for Hazardous Locations

Current offers the industry's most extensive portfolio of LED Lamps certified for use in hazardous locations. LED hazardous location lamps offer an opportunity to realize the benefits of an upgrade to LED lighting at an affordable cost. Retrofits certified to UL844 allow existing hazardous location fixtures to be used, while replacing old HID lamps and bypassing the ballasts. Lamps can provide an attractive ROI when entire fixture upgrades may be cost prohibitive, allowing hazardous location facilities to save on energy costs and improve light quality and reliability without compromising safety.

LED HID Lamps approved for hazardous locations provide customers an innovative lighting solution. These lamps maintain the key features of standard GE LED HID Lamps, with a proprietary active cooling design that allows high output from a compact form, with omnidirectional light output. With E26-based hazardous location lamps, Current also includes an E39 socket adapter in the kit for mogul base applications. This eliminates the possibility of ordering a lamp with the wrong base. The heat profile of Current's LED lamps is lower than traditional HID, which equates to a lower overall temperature code. This may provide additional benefits to a facility, beyond the lower energy consumption and increased longevity of the lamps themselves.



## LED HID - Type B - Hazardous Locations

Bulb Shape	Base Type <sup>1</sup>	Watts	Order Code	Description	Volts	Carton Qty <sup>2</sup>	MOL (in)	MOD (in)	Lumens (Initial)	Color Temp. (Initial)	CRI	Wattage Replacement <sup>3</sup>	Rated Life L70 (Hrs) <sup>1</sup>	DLC <sup>4</sup> ID <sup>3,4</sup>	Location Rating <sup>5</sup>
<b>LED Replacement Lamps for HID - Ballast Bypass (Type B) - Hazardous Locations</b>															
ED17	E26/EX39	21	93134832	LED21ED17/730/HAZ	120-277	3	5.4	2.6	3,000	3000K	>70	50W HPS / 70W MH	50,000	-	Damp
	E26/EX39	21	93134833	LED21ED17/740/HAZ	120-277	3	5.4	2.6	3,000	4000K	>70	50W HPS / 70W MH	50,000	-	Damp
	E26/EX39	21	93134834	LED21ED17/750/HAZ	120-277	3	5.4	2.6	3,000	5000K	>70	50W HPS / 70W MH	50,000	-	Damp
	E26/EX39	35	93134830	LED35ED17/740/HAZ	120-277	3	5.4	2.6	5,000	4000K	>70	70W HPS / 100W MH	50,000	-	Damp
	E26/EX39	35	93134831	LED35ED17/750/HAZ	120-277	3	5.4	2.6	5,000	5000K	>70	70W HPS / 100W MH	50,000	-	Damp
	E26/EX39	45	93134846	LED45ED17/730/HAZ	120-277	3	5.4	2.6	6,000	3000K	>70	100W HPS / 100W MH	50,000	-	Damp
	E26/EX39	45	93134847	LED45ED17/740/HAZ	120-277	3	5.4	2.6	6,000	4000K	>70	100W HPS / 100W MH	50,000	-	Damp
	E26/EX39	45	93134848	LED45ED17/750/HAZ	120-277	3	5.4	2.6	6,000	5000K	>70	100W HPS / 100W MH	50,000	-	Damp
ED23.5	E26/EX39	80	93141934	LED80ED23.5/740/HAZ	120-277	3	7.8	3.7	12,000	4000K	>70	150W HPS / 250W MH	50,000	-	Damp
	E26/EX39	80	93141935	LED80ED23.5/750/HAZ	120-277	3	7.8	3.7	12,000	5000K	>70	150W HPS / 250W MH	50,000	-	Damp
	EX39	80	93148146	LED80ED23.5/740/277/480/HAZ	277-480	3	7.8	3.7	12,000	4000K	>70	150W HPS / 250W MH	50,000	S-3GZE5Y	Damp
ED28	EX39	80	93148147	LED80ED23.5/750/277/480/HAZ	277-480	3	7.8	3.7	12,000	5000K	>70	150W HPS / 250W MH	50,000	S-048JK5	Damp
	EX39	150	93154635	LED150ED28/740/HAZ	120-277	3	8.3	4.1	23,500	4000K	>70	310W HPS / 400W MH	50,000	S-EB9LHA	Damp
	EX39	150	93154636	LED150ED28/750/HAZ	120-277	3	8.3	4.1	23,500	5000K	>70	310W HPS / 400W MH	50,000	S-S2QAV1	Damp
	EX39	150	93154647	LED150ED28/740/277/480/HAZ	277-480	3	8.3	4.1	23,500	4000K	>70	310W HPS / 400W MH	50,000	S-ZN9G32	Damp
	EX39	150	93154648	LED150ED28/750/277/480/HAZ	277-480	3	8.3	4.1	23,500	5000K	>70	310W HPS / 400W MH	50,000	S-6UW8HL	Damp

Additional Information for LED Replacement Lamps for HID: Open and Closed Rated - Ballast bypass required  
 These products are covered by U.S. Patents 10788163 and 10508776. These products may also be covered by other U.S. patents or pending applications.

\* EX39 socket adapter is included with HAZ E26 based lamps for mogul base applications.

<sup>1</sup> The life rating is based on the hours of operation the lamp will provide before reaching 70% of its original lumen output (L70)

<sup>2</sup> Minimum order quantity = 1

<sup>3</sup> E26 based products are not eligible for DLC. Not all product variations on this page are DLC qualified. Visit [qpl.designlights.org/solid-state-lighting](http://qpl.designlights.org/solid-state-lighting) to confirm qualification.

<sup>4</sup> Do not use with phase-cut dimmers. Dimming functions only with external Variac control devices.

<sup>5</sup> UL 1993 Environmental Requirements for LED LAMPS

Damp Location - Exterior or interior location that is normally or periodically subject to condensation of moisture in, on, or adjacent to electrical equipment, including partially protected locations

<sup>6</sup> Wattage Replacement levels correspond with wattage levels. Wattage Replacements based on NEMA Standards Publication LL 10-2020 *Replacing HID Lamps with LED Lamps: Light Output Equivalency Claims*.

© See Installation Guide for applicable Hazardous Location luminaire fittings



## What's Considered a Hazardous Location?

The National Electrical Code (NEC) defines hazardous locations in terms of CLASS, DIVISION and GROUP:

- **CLASS I** locations are those in which flammable gases or vapors are or may be present in the air in quantities sufficient to produce explosive or ignitable mixtures.
- **CLASS II** locations are those that are hazardous because of the presence of combustible dust.

Each CLASS is further defined as either DIVISION 1 or DIVISION 2.

- **DIVISION 1** is an environment that is normally hazardous.
- **DIVISION 2** is an environment that is not normally hazardous.

**GROUP** defines the specific hazardous material in the surrounding atmosphere. See the table below for specific examples.

NEC Class	Division	Group	Typical Atmosphere and Auto-ignition Temperatures
I - Gases, Vapors	2 - Not normally present	A	Acetylene (305°C, 581°F)
		B	Hydrogen (502°C, 986°F) manufactured gases containing more than 30% hydrogen (by volume)
		C	Ethylene (450°C, 842°F) Cyclopropane (503°C, 938°F)
		D	Hexane (225°C, 437°F) Butane (288°C, 550°F) Propane (450°C, 842°F) Acetone (465°C, 869°F) Benzene (420°C, 788°F) Gasoline (280°-471°C, 536°-880°F)
II - Combustible Dusts	1 - Normally present	E	Metal Dusts (Aluminum, Magnesium)
	2 - Not normally present	F	Carbonaceous Dusts (Coal, Carbon black, Charcoal, Coke)
		G	Dusts not in Groups E or F (Flour, Grain, Wood, Plastic)

*Typical Hazardous Substances and Auto-ignition Temperatures by Group*

## How are LED Retrofits Certified?

UL evaluates Retrofit Luminaire Conversion Kits for Use in Hazardous Locations in accordance with the appropriate Standards. LED Lamps are UL-certified as part of Retrofit Kits that also include an installation guide detailing instructions for retrofitting hazardous location luminaires and a fixture label that indicates the lamp being used and associated new temperature code.

[See lamp installation guides for full luminaire fitting details.](#)

## Current Hazardous Location Lamps – Approved UL Fixtures by Classification

Classifications: Class 1, Division 2, Groups A, B, C, D				Classifications: Class 2, Division 1, Groups E, F, G; Class 2, Division 2, Groups F, G			
UL HazLoc Fixture Type	ED17	ED23.5	ED28	UL HazLoc Fixture Type	ED17	ED23.5	ED28
GE Filtr-Gard® H2	Yes	Yes	Yes	GE Filtr-Gard® H2	-	-	-
GE Powr-Gard® H9	-	-	-	GE Powr-Gard® H9	Yes	Yes	-
Appleton Mercmaster™ II	Yes	Yes	Yes	Appleton Mercmaster™ II	Yes	Yes	Yes
Appleton Mercmaster™ III	Yes	Yes	Yes	Appleton Mercmaster™ III	Yes	Yes	Yes
Crouse-Hinds Champ® VMV	Yes	Yes	Yes	Crouse-Hinds Champ® VMV	Yes	-	Yes
Thomas & Betts Hazlux® 3	Yes	Yes	Yes	Thomas & Betts Hazlux® 3	Yes	Yes	Yes
Hubbell Killark® VM Series	Yes	Yes	Yes	Hubbell Killark® VM Series	Yes	Yes	Yes
Holophane Petrolux® P3M	Yes	Yes	-	Holophane Petrolux® P3M	Yes	Yes	-
Holophane Petrolux® II PETL	-	-	Yes	Holophane Petrolux® II PETL	-	-	Yes

# LED Lamps - HID - Hazardous Locations



## Ohio Manufacturing Facility Replaces Dated HPS Lamps with New Current LED HID Lamps Approved for Hazardous Locations



Before: 250W High Pressure Sodium Lamps

After: 45W ED17 LED HID Lamps

An Ohio-based company needed a solution for a dimly lit manufacturing plant, and Current jumped at the opportunity to help. This wasn't a normal lamp refit, but Current knew its expansive LED Lamp portfolio had a product up for the challenge.

From the outset of the project, it was apparent that the customer needed lamps that would fit into traditional hazardous rated High Pressure Sodium (HPS) fixtures. Installation needed to be quick to avoid downtime, and budgets were tight, so avoiding significant renovations was preferred. The new LED HID replacement lamps needed to be approved for hazardous rated fixtures, as the plant deals with hazardous materials in its processes.

### The Solution

Current recommended its Hazardous LED HID Replacement Lamps. These LED lamps are designed for those rugged environments where long lasting performance is a necessity. Current's LED HID replacement lamps for hazardous locations are certified for use in a variety of hazardous location luminaires, including Class I Division 2, Class II Division 1, and Class II Division 2 applications.

With a much longer life compared to a standard HID lamp, these LED lamps would provide consistent, dependable lighting in a facility that desperately needed it. The LED lamps use much less energy compared with their HPS counterparts. This not only saves money, but it also provides the facility with an improved temperature code. This is important as it reduces the ambient temperature of the fixture by an average of 95°C in the most commonly used fixtures. By lowering the temperature code, you decrease the air temperature around the fixture, which makes for a safer operating environment. This allows customers the ability to install higher lumen lamps in locations that they were previously only able to provide low wattage/lumen lamps.

### Why Current's Lamps

One consideration for this plant was ongoing maintenance. Its existing lighting was not easy to replace and required significant manpower to maintain or update. Current was able to give them a solution that would last 2.5 times longer while still delivering a more efficient and effective solution. At the beginning of the installation, the team quickly realized they had fixtures with both medium (E26) and mogul (E39) sockets, which posed an issue with managing multiple lamp designs for the installation. Current's product team prepared for this exact scenario by including a mogul-base (E39) adapter with each lamp. Current's product strategy eliminated the possibility of ordering a lamp with the wrong base and the installer having to come back at a later date at an additional charge. This also reduces the SKU count for a project.

In addition to the longer life of LEDs, the industrial plant was also drawn to the fact that Current's lamps can go from a 250W HPS Lamp all the way down to 45W, which means increased savings in addition to longer life. The plant is now realizing \$25,000 annual savings compared to their traditional lamps. Over the life of the lamp, they will save \$125,000, and switching to Current's Hazardous Location LED HID replacement lamps will help them achieve payback in just 9 months.

Many manufacturing areas face uneven light distribution and dark spots. Most common is burned out lamps that cost time and money to replace because operations have to stop while these are fixed. Current's hazardous location lamps offer a five-year/50,000-hour warranty to give the end user peace of mind and avoid these issues.

# LED Lamps - HID - Hazardous Locations



## The Results

Installing the lamps was a smooth process. Once the new lights were turned on, the change was obvious: Areas were brighter.

The feedback from members working in the facility is overwhelmingly positive. They report that spaces are much brighter, providing better visibility in places that used to be very dark, and making the plant look and feel like a better place to work. In fact, the facility has already requested additional lamp retrofits in the plant due to the success and effectiveness they are witnessing after just a few weeks.

“The rooms look fantastic, it’s way easier to work and see, and instantly modernizes and brightens the entire area. It’s hard to believe, and somewhat embarrassing, that we lived with and just accepted the old lighting for so long,” the plant manager said.

Another worker added, “The new LED lamps make a drastic difference throughout our facility. With the new upgrade from the old yellow tinted HPS lights, some areas that once had a dark and gloomy feeling have now become areas where our employees want to work. It is amazing how something so little can improve the area and the site’s morale so much.”

Current’s Hazardous Location LED HID Replacement Lamps were the perfect solution for this manufacturing plant. Now, with better lighting, lower maintenance costs and reduced energy expenses, the facility can be safer and more productive.

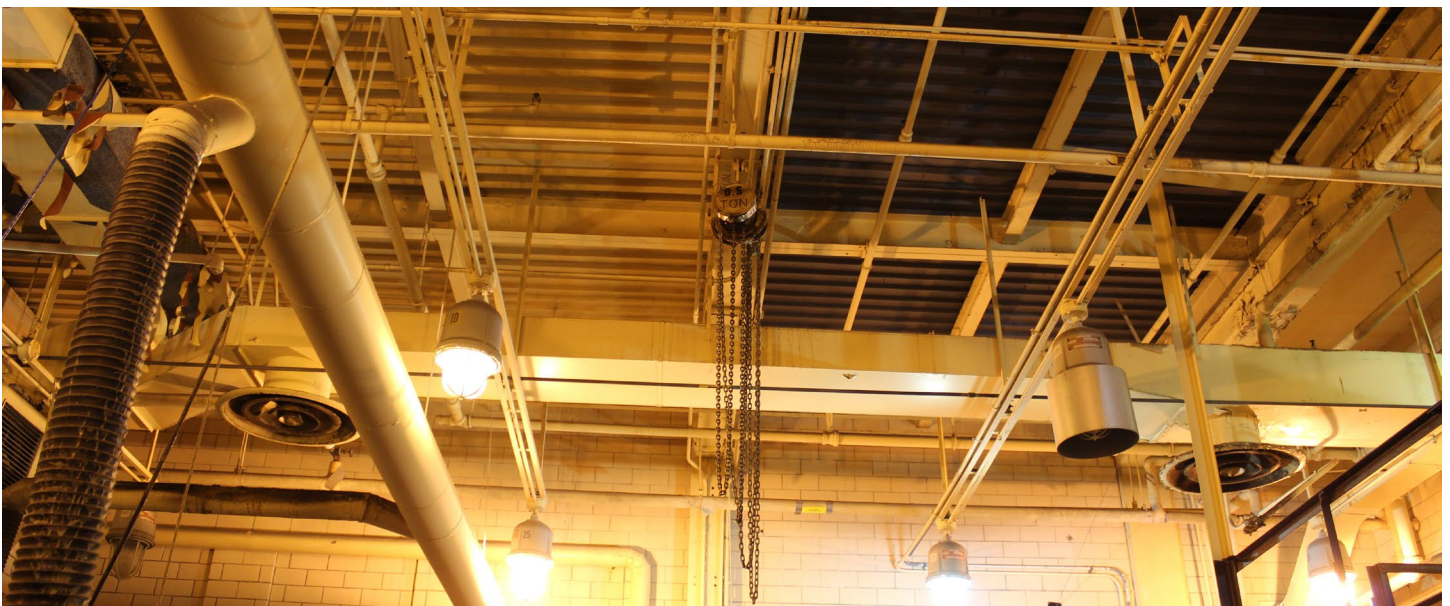

# LED Lamps - Plug-in - Type A



## LED Lamps - Type A Plug-ins

Type A LED plug-in lamps are direct replacements for pin-based compact fluorescent lamps. These lamps operate from CFL ballasts. Horizontal and vertical orientation lamps are offered in order to minimize energy consumption and improve fixture efficiency. Choose the lamp orientation that suits the application.



# LED Lamps - Plug-in - Type A



## Catalog Logic:

### Bulb Shape:

Bulb shape followed by its size (the maximum diameter of the bulb expressed in eighths of an inch).

**Watts:**  
Nominal Lamp  
Watts on ballast

**Order Code:**  
Use the order code when ordering to ensure that you receive the exact product you require

**Description:**  
Lamp Model  
Description

**Carton Quantity:**  
Number of lamps  
packed in a  
carton

**MOL (in):**  
Maximum Overall  
Length in inches

**Lumens:**  
Light output (as defined by  
FTC Lamp Label Rules)

**Color Temperature (K):**  
A measure of the visual  
"warmth" or "coolness"  
of the light from the  
lamp. The higher  
the value, the whiter  
or "cooler" the light  
appears.

**Color Rendering Index (CRI or R):**  
An indication of the ability of the  
lamp to render object colors in a  
normal natural way. The higher the  
number (0-100), the better the color  
appearance.

**Dimmable:**  
Indicates whether a lamp  
is dimmable or not

**Wattage Replacement:**  
Wattage of Traditional  
Lamp the LED Lamp is  
meant to replace

**Location Rating:**  
Location Rating as defined  
for LED Lamps by UL 1993

**Additional Information:**  
Typical application and/or  
other important information

**DLC:**  
Indicates whether product  
is listed on the DesignLights  
Consortium Qualified  
Products List

**Rated Life L70:**  
Hours of operation  
the lamp will provide  
before reaching 70%  
of its original lumen  
output

Bulb Shape	Base Type	Lamp Watts	Order Code	Description	Carton Qty <sup>2</sup>	MOL (in)	Lumens (Initial)	Color Temp (Initial) CRI	Wattage Replacement	Rated Life L70 (Hrs) <sup>1</sup>	Dimmable	DLC <sup>4</sup>	Location Rating <sup>3</sup>	Additional Information <sup>5</sup>
Vertical Type A 4-pin														
Plug-In G24q/GX24q		9	33956	LED9G24Q-V/827	6	5.9	1100	2700K 80	13/18/26	50,000	-	-	Damp	Requires Electronic Ballast, Fully Enclosed

## LED9G24Q-V/827



## Lamp Drawings (not drawn to scale)

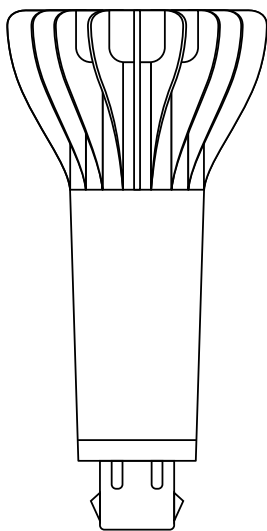

Type A  
GX24q

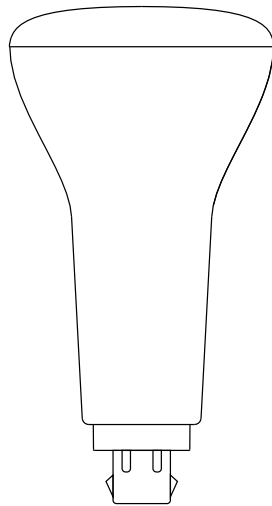

Type A  
G24q

Type A  
G24d

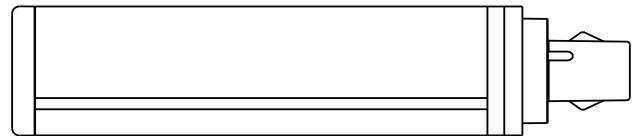

Type A  
G24q

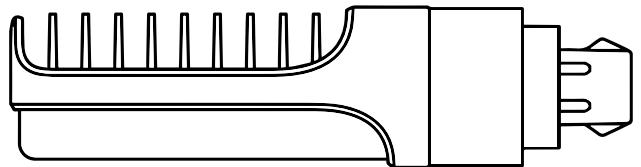



# LED Lamps - Plug-in - Type A

## Type A - 2-pin Plug-ins

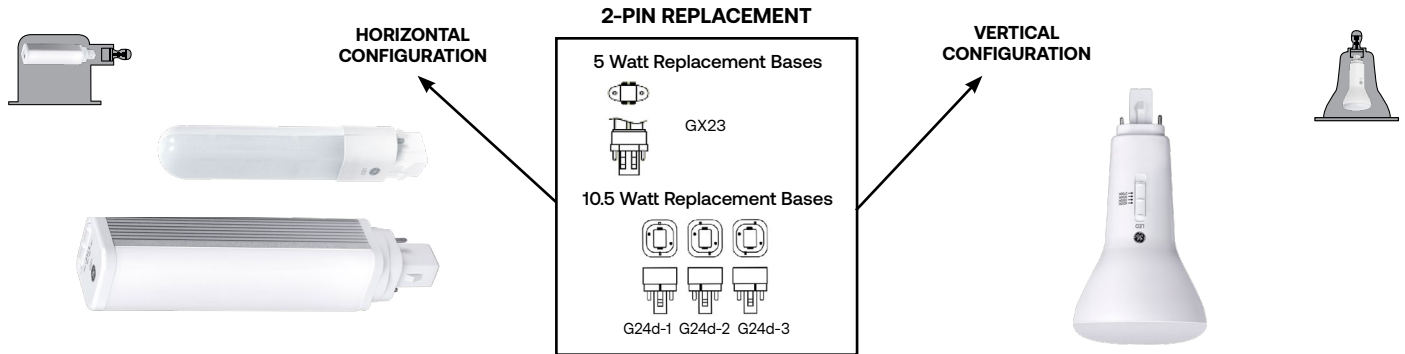

## Selectable SpectraChoice™ Type A - 2-pin Plug-in Lamps

Bulb Shape	Base Type	Lamp Watts	Order Code	Description	Carton Qty <sup>2</sup>	MOL (In)	Lumens (Initial) <sup>5</sup>	Color Temp* (Initial)	CRI	Wattage Replacement	Rated Life L70 (Hrs) <sup>1</sup>	DLC <sup>4</sup> ID <sup>4</sup>	Location Rating <sup>3</sup>	Additional Information <sup>^</sup>
<b>Vertical Type A G24d 2-pin</b>														
<b>Plug-In</b>							1000	2700K						
	G24d	10.5	93300091	LED1HG24d-V/8SC-4PK	24	6.2	1100	3000K	80	13/18/26	50,000	-	Damp	SpectraChoice™ Selectable Color Temperature (4000K Default), Requires Magnetic Ballast, Fully Enclosed, 4 pack
							1100	3500K						
							1100	4000K*						
<b>Horizontal Type A G24d 2-Pin</b>														
<b>Plug-In</b>							1000	2700K						
	G24d	10.5	93300090	LED1HG24d-H/8SC-4PK	24	6.6	1100	3000K	80	13/18/26	50,000	-	Damp	SpectraChoice™ Selectable Color Temperature (4000K Default), Requires Magnetic Ballast, Fully Enclosed, 4 pack
							1100	3500K						
							1100	4000K*						

## Type A - 2-pin Plug-in Lamps

Bulb Shape	Base Type	Lamp Watts	Order Code	Description	Carton Qty <sup>2</sup>	MOL (In)	Lumens (Initial) <sup>5</sup>	Color Temp* (Initial)	CRI	Wattage Replacement	Rated Life L70 (Hrs) <sup>1</sup>	DLC <sup>4</sup> ID <sup>4</sup>	Location Rating <sup>3</sup>	Additional Information <sup>^</sup>
<b>Type A GX23 2-pin</b>														
<b>Plug-In</b>	GX23	5	91404	LED5GX23/827	6	6.7	500	2700K	80	13	50,000	-	Damp	Requires Magnetic Ballast, Fully Enclosed
	GX23	5	91405	LED5GX23/830	6	6.7	530	3000K	80	13	50,000	-	Damp	Requires Magnetic Ballast, Fully Enclosed
	GX23	5	91407	LED5GX23/835	6	6.7	545	3500K	80	13	50,000	-	Damp	Requires Magnetic Ballast, Fully Enclosed
	GX23	5	91408	LED5GX23/840	6	6.7	560	4000K	80	13	50,000	-	Damp	Requires Magnetic Ballast, Fully Enclosed
	GX23	5	91410	LED5GX23/850	6	6.7	565	5000K	80	13	50,000	-	Damp	Requires Magnetic Ballast, Fully Enclosed
<b>Vertical Type A G24d 2-pin</b>														
<b>Plug-In</b>	G24d	10.5	92988	LED1HG24d-V/835	6	6.2	1050	3500K	80	13/18/26	50,000	-	Damp	Requires Magnetic Ballast, Fully Enclosed
	G24d	10.5	92996	LED1HG24d-V/840	6	6.2	1050	4000K	80	13/18/26	50,000	-	Damp	Requires Magnetic Ballast, Fully Enclosed

<sup>1</sup> The life rating is based on the hours of operation the lamp will provide before reaching 70% of its original lumen output (L70)

<sup>2</sup> Minimum order quantity = Carton Qty

<sup>3</sup> UL 1993 Environmental Requirements for LED LAMPS

Damp Location - Exterior or interior location that is normally or periodically subject to condensation of moisture in, on, or adjacent to electrical equipment, including partially protected locations

<sup>4</sup> DLC<sup>®</sup> does not have a category for two-pin plug-in lamps

<sup>5</sup> Lumen levels correspond with color temperature for selectable lamps

\* Default color temperature setting is 4000K for selectable lamps

<sup>^</sup> Check ballast compatibility at LED.com/LED2pin-compatibility



# LED Lamps - Plug-in - Type A

## Type A - 4-pin Plug-ins

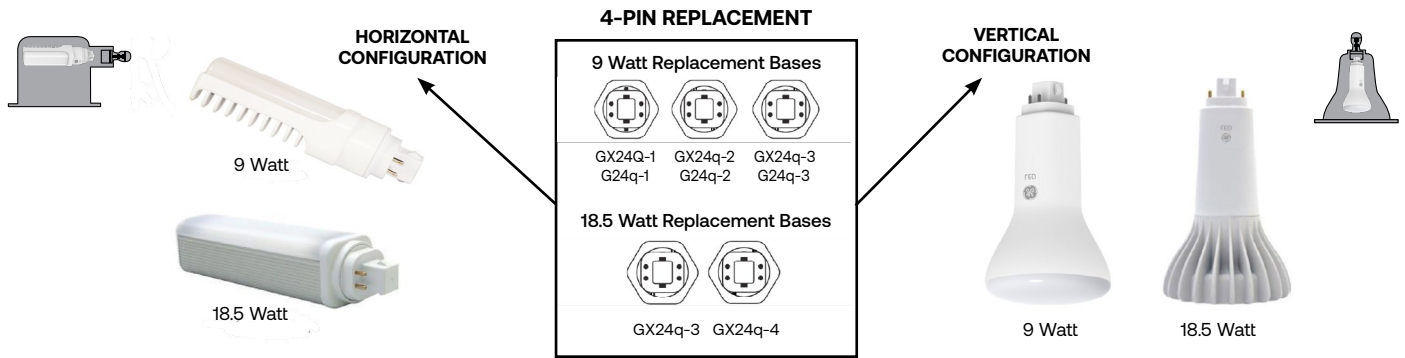

## Selectable SpectraChoice™ Type A - 4-pin Plug-in Lamps

Bulb Shape	Base Type	Lamp Watts	Order Code	Description	Carton Qty <sup>2</sup>	MOL (In)	Lumens (Initial) <sup>5</sup>	Color Temp* (Initial)	CRI	Wattage Replacement	Rated Life L70 (Hrs) <sup>1</sup>	DLC <sup>3</sup> ID <sup>4</sup>	Location Rating <sup>3</sup>	Additional Information <sup>4</sup>
<b>Vertical Type A 4-pin</b>														
Plug-In	G24q/GX24q	9	93300089	LED9G24q-V/8SC-4PK	24	5.9	1000 1100 1100 1100	2700K 3000K 3500K 4000K*	80	13/18/26	50,000	S-WU5YE2	Damp	SpectraChoice™ Selectable Color Temperature (4000K Default), Requires Electronic Ballast, Fully Enclosed, 4 pack
Plug-In	G24q/GX24q	18.5	93314806	LED19GX24q-V/8SC	12	6.5	1850 1850 1850 1850	2700K 3000K 3500K 4000K*	80	32/42	50,000	-	Damp	SpectraChoice™ Selectable Color Temperature (4000K Default), Requires Electronic Ballast
<b>Horizontal Type A 4-pin</b>														
Plug-In	G24q/GX24q	18.5	93314804	LED19GX24q-H/8SC	12	6.8	1850 1850 1850 1850	2700K 3000K 3500K 4000K*	80	32/42	50,000	-	Damp	SpectraChoice™ Selectable Color Temperature (4000K Default), Requires Electronic Ballast

## Type A - 4-pin Plug-in Lamps

Bulb Shape	Base Type	Lamp Watts	Order Code	Description	Carton Qty <sup>2</sup>	MOL (In)	Lumens (Initial) <sup>5</sup>	Color Temp* (Initial)	CRI	Wattage Replacement	Rated Life L70 (Hrs) <sup>1</sup>	DLC <sup>3</sup> ID <sup>4</sup>	Location Rating <sup>3</sup>	Additional Information <sup>4</sup>	
<b>Vertical Type A 4-pin</b>															
	Plug-In	G24q/GX24q	9	33969	LED9G24Q-V/830	6	5.9	1200	3000K	80	13/18/26	50,000	-	Damp	Requires Electronic Ballast, Fully Enclosed
		GX24q	18.5	39288	LED19GX24q-V/827	6	6.42	1800	2700K	80	32/42	50,000	-	Damp	Requires Electronic Ballast
		GX24q	18.5	39277	LED19GX24q-V/830	6	6.42	1850	3000K	80	32/42	50,000	-	Damp	Requires Electronic Ballast
		GX24q	18.5	39275	LED19GX24q-V/835	6	6.42	1950	3500K	80	32/42	50,000	-	Damp	Requires Electronic Ballast
	GX24q	18.5	39279	LED19GX24q-V/840	6	6.42	1950	4000K	80	32/42	50,000	-	Damp	Requires Electronic Ballast	
<b>Horizontal Type A 4-pin</b>															
	Plug-In	G24q/GX24q	9	33994	LED9G24Q-H/827	6	5.31	1100	2700K	80	13/18/26	50,000	S-6PKGMC	Damp	Requires Electronic Ballast, Fully Enclosed
		G24q/GX24q	9	33997	LED9G24Q-H/830	6	5.31	1200	3000K	80	13/18/26	50,000	S-RVMHOC	Damp	Requires Electronic Ballast, Fully Enclosed
		G24q/GX24q	9	33998	LED9G24Q-H/835	6	5.31	1200	3500K	80	13/18/26	50,000	S-HOEDLY	Damp	Requires Electronic Ballast, Fully Enclosed
		G24q/GX24q	9	33999	LED9G24Q-H/840	6	5.31	1200	4000K	80	13/18/26	50,000	S-3FW29C	Damp	Requires Electronic Ballast, Fully Enclosed
		GX24q	18.5	39289	LED19GX24q-H/827	6	6.7	1850	2700K	80	32/42	50,000	-	Damp	Requires Electronic Ballast
		GX24q	18.5	39282	LED19GX24q-H/830	6	6.7	1850	3000K	80	32/42	50,000	-	Damp	Requires Electronic Ballast
		GX24q	18.5	39276	LED19GX24q-H/835	6	6.7	1950	3500K	80	32/42	50,000	-	Damp	Requires Electronic Ballast
		GX24q	18.5	39283	LED19GX24q-H/840	6	6.7	1950	4000K	80	32/42	50,000	-	Damp	Requires Electronic Ballast

## Type A - High Lumen Biax 2G11 Plug-in Lamps

Bulb Shape	Base Type	Lamp Watts	Order Code	Description	Carton Qty <sup>2</sup>	MOL (In)	Lumens (Initial) <sup>5</sup>	Color Temp* (Initial)	CRI	Wattage Replacement	Rated Life L70 (Hrs) <sup>1</sup>	DLC <sup>3</sup> ID <sup>4</sup>	Location Rating <sup>3</sup>	Additional Information <sup>4</sup>	
<b>High Lumen Biax Type A (HLBX)</b>															
	HLBX	2G11	17	39073	LED172G11/830/10	10	22.3	2150	3000K	80	40	50,000	-	Damp	Instant or PRS Ballast
		2G11	17	39074	LED172G11/835/10	10	22.3	2150	3500K	80	40	50,000	-	Damp	Instant or PRS Ballast
		2G11	17	39075	LED172G11/840/10	10	22.3	2200	4000K	80	40	50,000	-	Damp	Instant or PRS Ballast
		2G11	17	39076	LED172G11/850/10	10	22.3	2200	5000K	80	40	50,000	-	Damp	Instant or PRS Ballast

<sup>1</sup> The life rating is based on the hours of operation the lamp will provide before reaching 70% of its original lumen output (L70)

<sup>2</sup> Minimum order quantity = Carton Qty

<sup>3</sup> UL 1993 Environmental Requirements for LED LAMPS

Damp Location - Exterior or interior location that is normally or periodically subject to condensation of moisture in, on, or adjacent to electrical equipment, including partially protected locations

<sup>4</sup> Not all product variations on this page are DLC qualified. Visit [qpl.designlights.org/solid-state-lighting](http://qpl.designlights.org/solid-state-lighting) to confirm qualification.

<sup>5</sup> Lumen levels correspond with color temperature for selectable lamps

\* Default color temperature setting is 4000K for selectable lamps

\* Check ballast compatibility at [LED.com/LED4pin-compatibility](http://LED.com/LED4pin-compatibility) for G24q/GX24q lamps. Check ballast compatibility at [LED.com/LED2G11-compatibility](http://LED.com/LED2G11-compatibility) for 2G11 lamps.

# LED Lamps - Plug-in - Type B



## LED Lamps - Type B Plug-ins

Type B LED plug-in lamps offer the opportunity to replace pin-based compact fluorescent lamps and eliminate costs related to the ballasts. Type B lamps operate from mains voltage. The fixture is re-wired to bypass the ballast. Horizontal and vertical orientation lamps are offered in order to minimize energy consumption and improve fixture efficiency. Choose the lamp orientation that suits the application.

### Lamp Drawings (not drawn to scale)

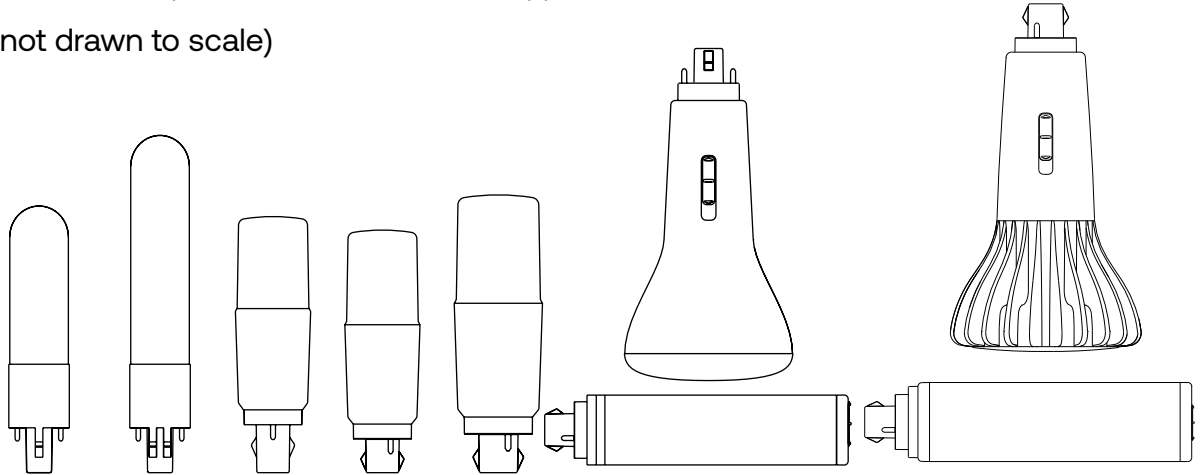

Base	G23	GX23	GX23-2	G24	G24	G24	G24
Fits In Sockets	G23	GX23	GX23-2	G24d G24q GX24q	G24d G24q GX24q	G24d G24q GX24q	G24d G24q GX24q
Input Voltage	120-277	120-277	120-277	120-277	120-277	120-347	120-347
Color Temperature	2700K 3000K 3500K 4000K	2700K 3000K 3500K 4000K 5000K	2700K 3000K 3500K 4000K	2700K 3000K 3500K 4000K	2700K 3000K 3500K 4000K	SpectraChoice™ 2700K 3000K 3500K 4000K	SpectraChoice™ 2700K 3000K 3500K 4000K
Rated Life (L70)	50,000	50,000	20,000	20,000	50,000	50,000	50,000
Lumens	500	500	800	850	1200	1100	1850
Light Distribution	Directional	Directional	Omnidirectional	Omnidirectional	Omnidirectional	Directional	Directional
Wattage	5W	5W	7.5W	7.5W	10W	10.5W	18W
CFL Equivalent	7/9W	13W	13W	13W	18W	13/18/26W	32/42W

Heat sink for thermal management enables long life

Plastic lens provides excellent diffusion



Type B G24 Horizontal

Horizontal orientation lamps feature a rotatable base



Type B G24 Vertical

G24 Type B plug-in bases can be used in a variety of sockets



# LED Lamps - Plug-in - Type B



## Catalog Logic:

### Bulb Shape:

Bulb shape followed by its size (the maximum diameter of the bulb expressed in eighths of an inch).

### Color Rendering Index (CRI or R):

An indication of the ability of the lamp to render object colors in a normal natural way. The higher the number (0-100), the better the color appearance.

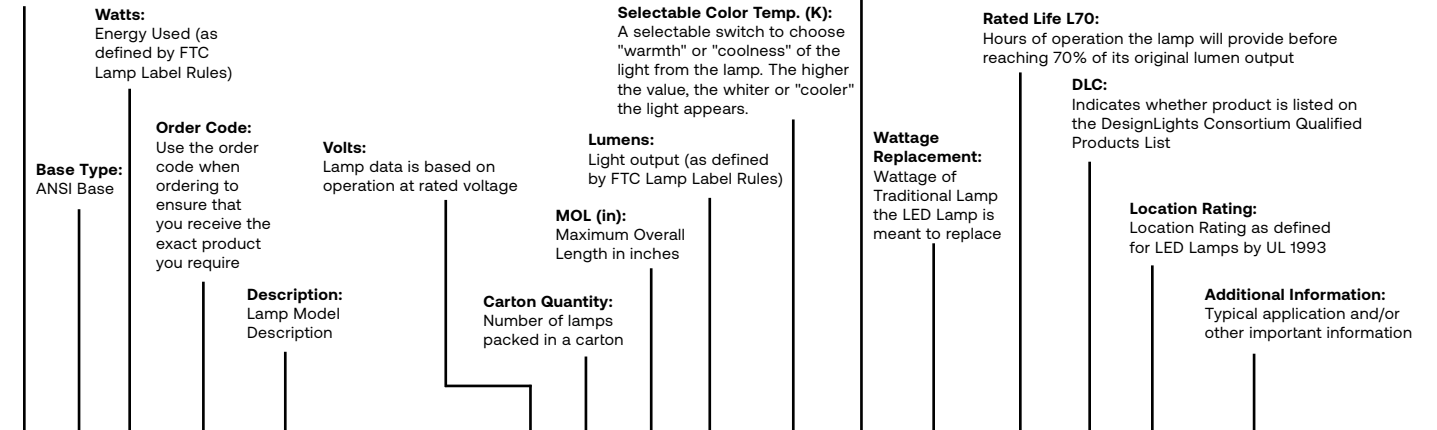

Bulb Shape	Base Type	Watts	Order Code	Description	Volts	Carton Qty <sup>2</sup>	MOL (In)	Lumens (Initial) <sup>5</sup>	Selectable Color Temp. (Initial)*	CRI	Wattage Replacement	Rated Life L70 (Hrs) <sup>1</sup>	DLC <sup>4</sup>	Location Rating <sup>3</sup>	Additional Information
------------	-----------	-------	------------	-------------	-------	-------------------------	----------	-------------------------------	-----------------------------------	-----	---------------------	-----------------------------------	------------------	------------------------------	------------------------

Vertical Type B 2-pin - Fits in G24d and G24q sockets - Selectable Color Temperature - Ballast Bypass

Plug-In															
	G24	10.5	93300088	LED11BG24-V/8SC/120-347-4PK	120-347	24	5.9	1000 1100 1100 1100	2700K 3000K 3500K 4000K	80	13/18/26	50,000	-	Damp	SpectraChoice™ (4000K Default) Selectable Color Temperature, Ballast Bypass, Fully Enclosed, 4 pack

## LED11BG24-H/8SC/120-347-4PK

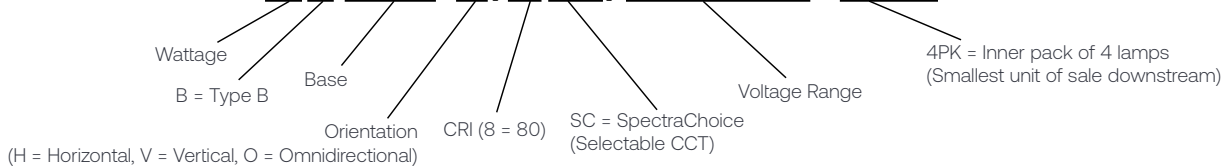

## Base Identification (not drawn to scale)

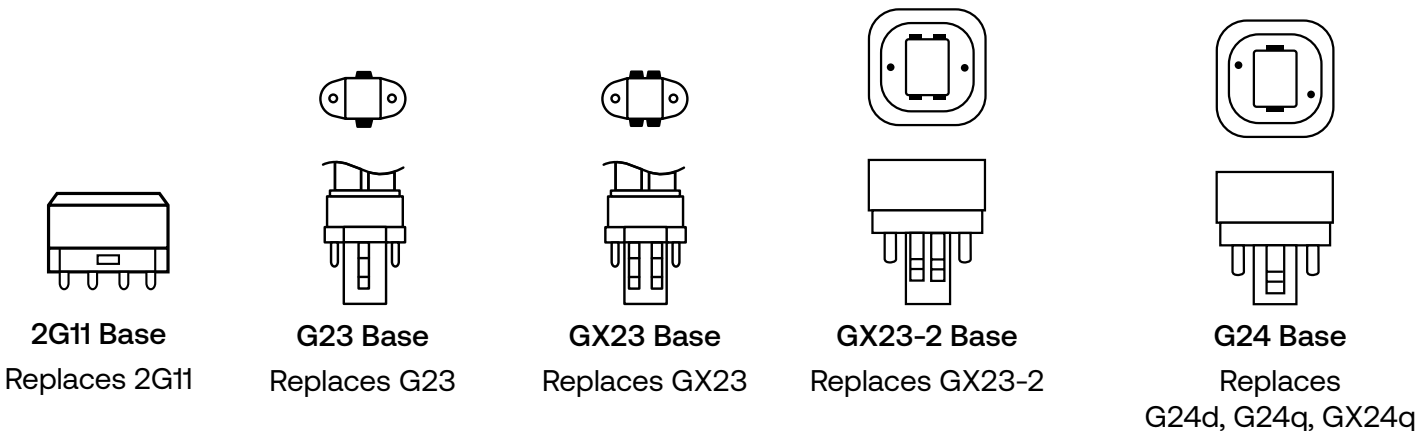

# LED Lamps - Plug-in - Type B



## LED Lamps - SpectraChoice™ Type B Plug-ins

SpectraChoice™ Type B Plug-in lamps feature built-in switches to select color temperature. Horizontal and vertical orientation lamps are offered in order to minimize energy consumption and improve fixture efficiency. Choose the lamp orientation that suits the application.

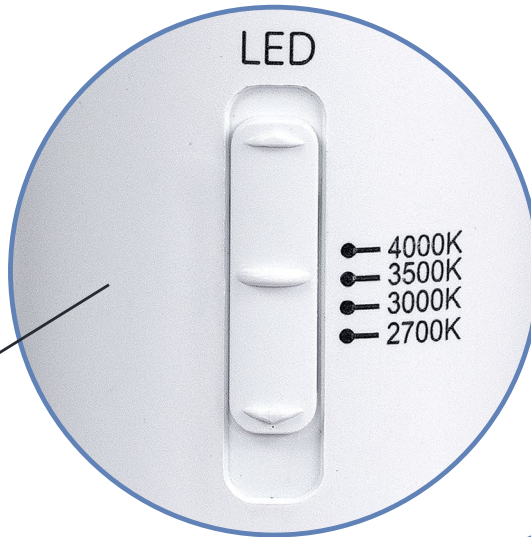

# LED Lamps - Plug-in - Type B



Type B LED plug-in lamps can be used in a variety of compact fluorescent sockets. By re-wiring the socket and eliminating concerns related to ballast compatibility, a single lamp can fit and operate in a wider variety of sockets. Type B LED plug-in lamp bases do not have exclusionary features related to specific wattages like CFL lamps do. A 2-pin G24 lamp can fit in 2-pin G24d or 4-pin G24q/GX24q sockets as shown below.

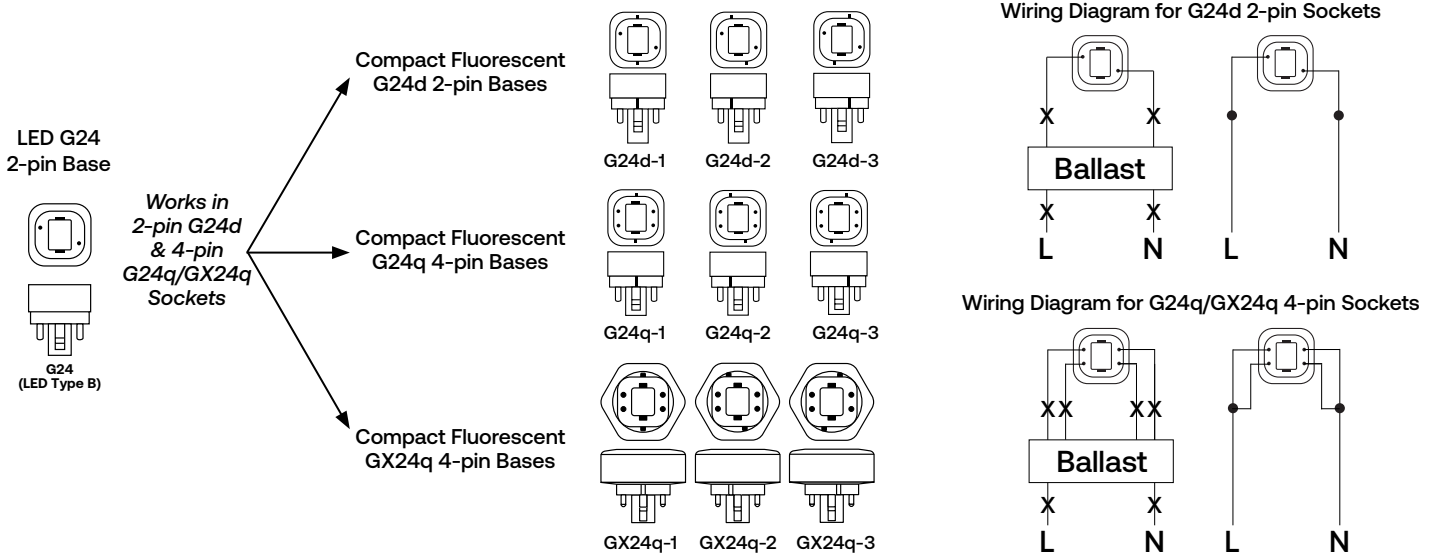

## Ballast Bypass Selectable SpectraChoice™ G24 Plug-in Lamps - Type B

Bulb Shape	Base Type	Watts	Order Code	Description	Carton Qty <sup>2</sup>	MOL (In)	MOD (In)	Lumens (Initial) <sup>5</sup>	Selectable Color Temp. (Initial)*		Wattage Replacement	Rated Life L70 (Hrs) <sup>1</sup>	DLC <sup>3</sup> ID <sup>4</sup>	Location Rating <sup>3</sup>	Additional Information	
									Volts	CRI						
<b>Vertical Type B 2-pin - Fits in G24d and G24q sockets - Selectable Color Temperature - Ballast Bypass</b>																
<b>Plug-In</b>																
	G24	10.5	93300088	LED18BG24-V/8SC/120-347-4PK	120-347	24	5.9	3.1	1000 1100 1100 1100	2700K 3000K 3500K 4000K*	80	13/18/26	50,000	-	Damp	SpectraChoice™ Selectable Color Temperature (4000K Default), Ballast Bypass, Fully Enclosed, 4 pack
	G24	18	93312489	LED18BG24-V/8SC/120-347	120-347	12	6.5	3.6	1850 1850 1850 1850	2700K 3000K 3500K 4000K*	80	32/42	50,000	-	Damp	SpectraChoice™ Selectable Color Temperature (4000K Default), Ballast Bypass, Fully Enclosed
<b>Horizontal Type B 2-pin - Fits in G24d and G24q sockets - Selectable Color Temperature - Ballast Bypass</b>																
<b>Plug-In</b>																
	G24	10.5	93300087	LED18BG24-H/8SC/120-347-4PK	120-347	24	6.4	1.9	1000 1100 1100 1100	2700K 3000K 3500K 4000K*	80	13/18/26	50,000	-	Damp	SpectraChoice™ Selectable Color Temperature (4000K Default), Ballast Bypass, Fully Enclosed, 4 pack
	G24	18	93312525	LED18BG24-H/8SC/120-347	120-347	12	6.8	2.3	1850 1850 1850 1850	2700K 3000K 3500K 4000K*	80	32/42	50,000	-	Damp	SpectraChoice™ Selectable Color Temperature (4000K Default), Ballast Bypass, Fully Enclosed

<sup>1</sup> The life rating is based on the hours of operation the lamp will provide before reaching 70% of its original lumen output (L70)

<sup>2</sup> Minimum order quantity = Carton Qty

<sup>3</sup> UL 1993 Environmental Requirements for LED LAMPS

Damp Location - Exterior or interior location that is normally or periodically subject to condensation of moisture in, on, or adjacent to electrical equipment, including partially protected locations

<sup>4</sup> DLC® does not have a category for two-pin plug-in lamps

<sup>5</sup> Lumen levels correspond with color temperature

\* Default color temperature setting is 4000K

# LED Lamps - Plug-in - Type B

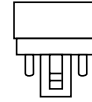

G24 Base

Replaces G24d & G24q

## Ballast Bypass Omnidirectional G24 Plug-in Lamps - Type B

Bulb Shape	Base Type	Watts	Order Code	Description	Volts	Carton Qty <sup>2</sup>	MOL (In)	MOD (In)	Lumens (Initial)	Color Temp. (Initial)	CRI	Wattage Replacement	Rated Life L70 (Hrs) <sup>1</sup>	DLC <sup>4</sup> ID <sup>4</sup>	Location Rating <sup>3</sup>	Additional Information
<b>Omnidirectional Type B 2-pin - Fits in G24d and G24q sockets - Ballast Bypass</b>																
Plug-In	G24	7.5	93300068	LED8BG24-O/827-4PK	120-277	24	4.4	1.5	800	2700K	80	13	20,000	-	Damp	Fully Enclosed, 4 pack
	G24	7.5	93300069	LED8BG24-O/830-4PK	120-277	24	4.4	1.5	850	3000K	80	13	20,000	-	Damp	Fully Enclosed, 4 pack
	G24	7.5	93300080	LED8BG24-O/835-4PK	120-277	24	4.4	1.5	850	3500K	80	13	20,000	-	Damp	Fully Enclosed, 4 pack
	G24	7.5	93300081	LED8BG24-O/840-4PK	120-277	24	4.4	1.5	850	4000K	80	13	20,000	-	Damp	Fully Enclosed, 4 pack
<b>Omnidirectional Type B 2-pin - Fits in G24d and G24q sockets - Ballast Bypass</b>																
Plug-In	G24	10	93300082	LED10BG24-O/827-4PK	120-277	24	5.4	1.8	1100	2700K	80	18	50,000	-	Damp	Fully Enclosed, 4 pack
	G24	10	93300083	LED10BG24-O/830-4PK	120-277	24	5.4	1.8	1200	3000K	80	18	50,000	-	Damp	Fully Enclosed, 4 pack
	G24	10	93300084	LED10BG24-O/835-4PK	120-277	24	5.4	1.8	1200	3500K	80	18	50,000	-	Damp	Fully Enclosed, 4 pack
	G24	10	93300086	LED10BG24-O/840-4PK	120-277	24	5.4	1.8	1200	4000K	80	18	50,000	-	Damp	Fully Enclosed, 4 pack

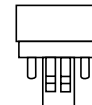

GX23-2 Base

Replaces GX23-2

## Ballast Bypass Omnidirectional GX23-2 Plug-in Lamps - Type B

Bulb Shape	Base Type	Watts	Order Code	Description	Volts	Carton Qty <sup>2</sup>	MOL (In)	MOD (In)	Lumens (Initial)	Color Temp. (Initial)	CRI	Wattage Replacement	Rated Life L70 (Hrs) <sup>1</sup>	DLC <sup>4</sup> ID <sup>4</sup>	Location Rating <sup>3</sup>	Additional Information
<b>Omnidirectional GX23-2 Plug-in Type B - Ballast Bypass</b>																
Plug-In	GX23-2	7.5	93312531	LED8BGX23-2-O/827	120-277	24	4.7	1.5	800	2700K	80	13	20,000	-	Damp	Ballast Bypass, Fully Enclosed
	GX23-2	7.5	93312537	LED8BGX23-2-O/830	120-277	24	4.7	1.5	800	3000K	80	13	20,000	-	Damp	Ballast Bypass, Fully Enclosed
	GX23-2	7.5	93312543	LED8BGX23-2-O/835	120-277	24	4.7	1.5	800	3500K	80	13	20,000	-	Damp	Ballast Bypass, Fully Enclosed
	GX23-2	7.5	93312549	LED8BGX23-2-O/840	120-277	24	4.7	1.5	800	4000K	80	13	20,000	-	Damp	Ballast Bypass, Fully Enclosed

<sup>1</sup> The life rating is based on the hours of operation the lamp will provide before reaching 70% of its original lumen output (L70)

<sup>2</sup> Minimum order quantity = Carton Qty

<sup>3</sup> UL 1993 Environmental Requirements for LED LAMPS

<sup>4</sup> Damp Location - Exterior or interior location that is normally or periodically subject to condensation of moisture in, on, or adjacent to electrical equipment, including partially protected locations

<sup>5</sup> DLC<sup>®</sup> does not have a category for two-pin plug-in lamps

# LED Lamps - Plug-in - Type B



**G23 Base**  
Replaces G23

## Ballast Bypass G23 Plug-in Lamps - Type B

Bulb Shape	Base Type	Watts	Order Code	Description	Volts	Carton Qty <sup>2</sup>	MOL (In)	Lumens (Initial)	Color Temp. (Initial)	CRI	Wattage Replacement	Rated Life L70 (Hrs) <sup>1</sup>	DLC <sup>3</sup> ID <sup>4</sup>	Location Rating <sup>3</sup>	Additional Information
<b>G23 Plug-In Type B - Ballast Bypass</b>															
Plug-In	G23	5	93312465	LED5BG23/827	120-277	24	5.4	500	2700K	80	7/9	50,000	-	Damp	Ballast Bypass, Fully Enclosed
	G23	5	93312471	LED5BG23/830	120-277	24	5.4	500	3000K	80	7/9	50,000	-	Damp	Ballast Bypass, Fully Enclosed
	G23	5	93312477	LED5BG23/835	120-277	24	5.4	500	3500K	80	7/9	50,000	-	Damp	Ballast Bypass, Fully Enclosed
	G23	5	93312483	LED5BG23/840	120-277	24	5.4	500	4000K	80	7/9	50,000	-	Damp	Ballast Bypass, Fully Enclosed

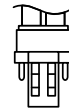

**GX23 Base**  
Replaces GX23

## Ballast Bypass GX23 Plug-in Lamps - Type B

Bulb Shape	Base Type	Watts	Order Code	Description	Volts	Carton Qty <sup>2</sup>	MOL (In)	Lumens (Initial)	Color Temp. (Initial)	CRI	Wattage Replacement	Rated Life L70 (Hrs) <sup>1</sup>	DLC <sup>3</sup> ID <sup>4</sup>	Location Rating <sup>3</sup>	Additional Information
<b>GX23 Plug-in Type B - Ballast Bypass</b>															
Plug-In	GX23	5	93312495	LED5BGX23/827	120-277	24	6.8	500	2700K	80	13	50,000	-	Damp	Ballast Bypass, Fully Enclosed
	GX23	5	93312501	LED5BGX23/830	120-277	24	6.8	500	3000K	80	13	50,000	-	Damp	Ballast Bypass, Fully Enclosed
	GX23	5	93312507	LED5BGX23/835	120-277	24	6.8	500	3500K	80	13	50,000	-	Damp	Ballast Bypass, Fully Enclosed
	GX23	5	93312513	LED5BGX23/840	120-277	24	6.8	500	4000K	80	13	50,000	-	Damp	Ballast Bypass, Fully Enclosed
	GX23	5	93312519	LED5BGX23/850	120-277	24	6.8	500	5000K	80	13	50,000	-	Damp	Ballast Bypass, Fully Enclosed

## Ballast Bypass High Lumen Biax 2G11 Plug-in Lamps - Type B

Bulb Shape	Base Type	Watts	Order Code	Description	Volts	Carton Qty <sup>2</sup>	MOL (In)	Lumens (Initial)	Color Temp. (Initial)	CRI	Wattage Replacement	Rated Life L70 (Hrs) <sup>1</sup>	DLC <sup>3</sup> ID <sup>4</sup>	Location Rating <sup>3</sup>	Additional Information
<b>High Lumen Biax Type B (HLBX) - Ballast Bypass</b>															
HLBX	2G11	17	93136025	LED17B2G11/830	120-277	10	22.3	2100	3000K	80	40	50,000	-	Damp	
	2G11	17	93136086	LED17B2G11/835	120-277	10	22.3	2100	3500K	80	40	50,000	-	Damp	
	2G11	17	93136087	LED17B2G11/840	120-277	10	22.3	2200	4000K	80	40	50,000	-	Damp	
	2G11	17	93136088	LED17B2G11/850	120-277	10	22.3	2200	5000K	80	40	50,000	-	Damp	

<sup>1</sup> The life rating is based on the hours of operation the lamp will provide before reaching 70% of its original lumen output (L70)

<sup>2</sup> Minimum order quantity = Carton Qty

<sup>3</sup> UL 1993 Environmental Requirements for LED LAMPS

Damp Location - Exterior or interior location that is normally or periodically subject to condensation of moisture in, on, or adjacent to electrical equipment, including partially protected locations

<sup>4</sup> Not all product variations on this page are DLC qualified. DLC<sup>3</sup> does not have a category for two-pin plug-in lamps. Visit [qpl.designlights.org/solid-state-lighting](http://qpl.designlights.org/solid-state-lighting) to confirm qualification.

# LED Lamps – Directional



## LED Lamps – PARs

Current offers LED PAR lamps featuring the exclusive Visual Comfort Lens design. With advanced optics and reduced glare, these lamps offer the light qualities desired by merchants for retail applications.

High output and value lines are also available to serve applications needing higher lumens or when advanced optics are not required.



# LED Lamps - Directional



## Catalog Logic:

**Bulb Shape:**  
Bulb shape followed by its size (the maximum diameter of the bulb expressed in eighths of an inch).

**Watts:**  
Energy Used (as defined by FTC Lamp Label Rules)

**Lumens:**  
Light output (as defined by FTC Lamp Label Rules)

**Color Rendering Index (CRI or R):**  
An indication of the ability of the lamp to render object colors in a normal natural way. The higher the number (0-100), the better the color appearance.

**Dimmable:**  
Indicates whether a lamp is dimmable or not

**Base Type:**  
ANSI Base

**Order Code:**  
Use the order code when ordering to ensure that you receive the exact product you require

**Volts:**  
Lamp data is based on operation at rated voltage

**MOL (in):**  
Maximum Overall Length in inches

**Color Temperature (K):**  
A measure of the visual "warmth" or "coolness" of the light from the lamp. The higher the value, the whiter or "cooler" the light appears.

**Wattage Replacement:**  
Wattage of Traditional Lamp the LED Lamp is meant to replace

**Location Rating:**  
Location Rating as defined for LED Lamps by UL 1993

**Description:**  
Lamp Model Description

**Carton Quantity:**  
Number of lamps packed in a carton

**CBCP:**  
Center Beam Candle Power

**Rated Life L70:**  
Hours of operation the lamp will provide before reaching 70% of its original lumen output

**Additional Information:**  
Typical application and/or other important information

**Beam Angle:**  
Degrees

**Housing Color:**  
Color of lamp body

Bulb Shape	Base Type	Watts	Order Code	Description	Carton Qty	MOL (in)	Lumens (Initial)	Color Temp. (Initial)	CRI	Wattage Replacement	Rated Life L70 (Hrs)	Dimmable	Location Rating	Beam Angle	Housing Color	Additional Information
PAR38	E26	18	87917	LED18D38OW3835/40	6	5.31	1700	4400	3500K	81	150	Yes	Wet	40°	White	

## LED18D38OW3835/40



## Lamp Drawings (not drawn to scale)

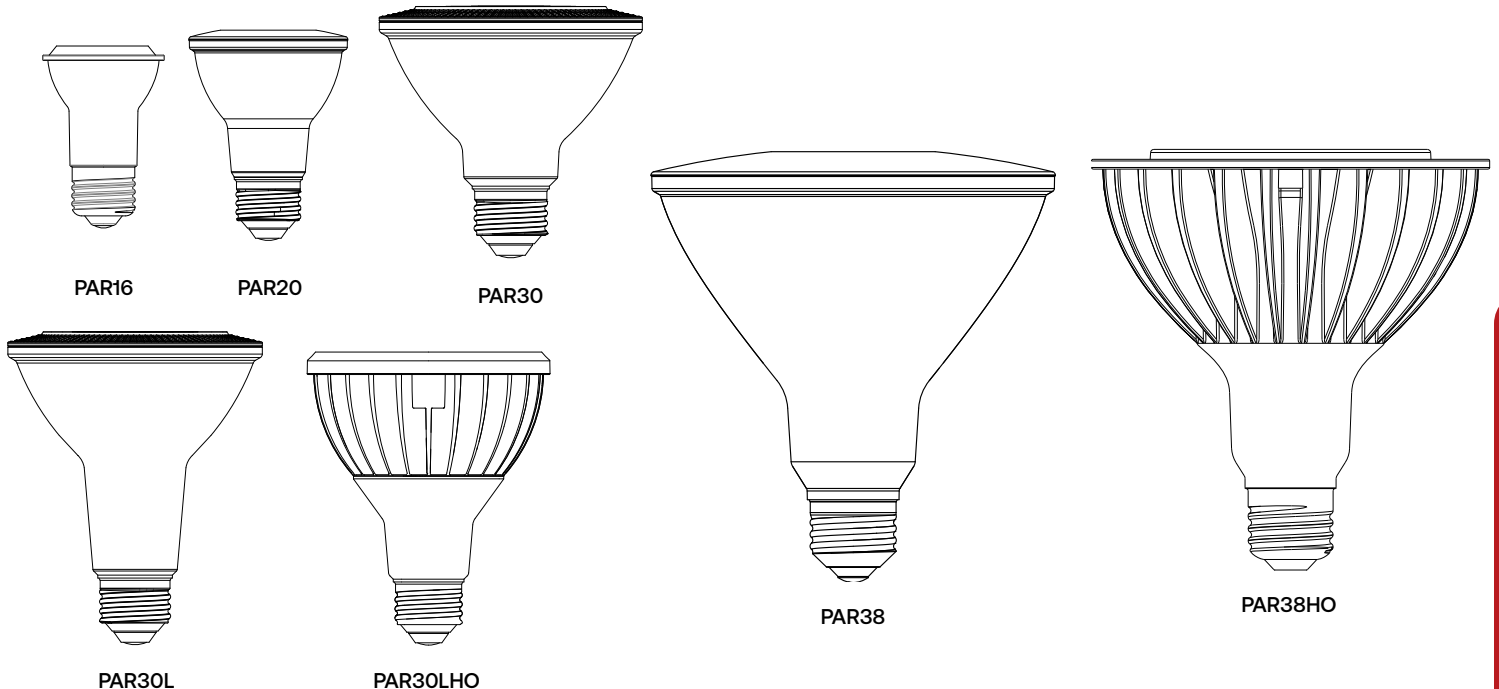

# LED Lamps - Directional



## Directional Lamps (PAR16 - PAR20)

Bulb Shape	Base Type	Watts	Order Code	Description	Volts	Carton Qty <sup>2</sup>	MOL (in)	Lumens (Initial)	CBCP	Color Temp. (Initial)	CRI	Wattage Replacement	Rated Life L70 (Hrs) <sup>1</sup>	Dim-mable	Location Rating <sup>3</sup>	Beam Angle	Housing Color	Additional Information	
<b>Compact PAR16</b>																			
PAR16	E26	6	93305603	LED6DP16W830/35-6PK	120	24	3.0	550	1000	3000K	80	60	25,000	Yes	Damp	35°	White	6 pack	
<b>Compact PAR20</b>																			
PAR20	E26	7	93349	LED7DP203B827/20	120	6	3.5	500	3600	2700K	80	50	25,000	Yes	Damp	20°	Black		
	E26	7	93360	LED7DP203W827/20	120	6	3.5	500	3600	2700K	80	50	25,000	Yes	Damp	20°	White		
	E26	7	93311901	LED7DP200B927/35	120	6	3.5	500	966	2700K	90	50	25,000	Yes	Wet	35°	Black	CEC Title 20	
	E26	7	93354	LED7DP203B827/35	120	6	3.5	500	1150	2700K	80	50	25,000	Yes	Damp	35°	Black		
	E26	7	93107782	LED7DP203W927/35	120	6	3.5	430	1000	2700K	90	50	25,000	Yes	Damp	35°	White		
	E26	7	93311900	LED7DP200W927/35	120	6	3.5	500	966	2700K	90	50	25,000	Yes	Wet	35°	White	CEC Title 20	
	E26	7	93362	LED7DP203W827/35	120	6	3.5	500	1150	2700K	80	50	25,000	Yes	Damp	35°	White		
	E26	7	93327	LED7DP203B830/20	120	6	3.5	520	3600	3000K	80	50	25,000	Yes	Damp	20°	Black		
	E26	7	93347	LED7DP203W830/20	120	6	3.5	520	3600	3000K	80	50	25,000	Yes	Damp	20°	White		
	E26	7	93311903	LED7DP200B930/35	120	6	3.5	520	966	3000K	90	50	25,000	Yes	Wet	35°	Black	CEC Title 20	
	E26	7	93311902	LED7DP200W930/35	120	6	3.5	520	966	3000K	90	50	25,000	Yes	Wet	35°	White	CEC Title 20	

## Directional Lamps (PAR30 - Visual Comfort Lens)

Bulb Shape	Base Type	Watts	Order Code	Description	Volts	Carton Qty <sup>2</sup>	MOL (in)	Lumens (Initial)	CBCP	Color Temp. (Initial)	CRI	Wattage Replacement	Rated Life L70 (Hrs) <sup>1</sup>	Dim-mable	Location Rating <sup>3</sup>	Beam Angle	Housing Color	Additional Information	
<b>PAR30 - Low Glare - Visual Comfort Lens</b>																			
PAR30	E26	12	93311923	LED12DP30RW927/25	120	6	3.6	1050	3800	2700K	90	75	25,000	Yes	Damp	25°	White	CEC Title 20	
	E26	12	42133	LED12DP30RW827/25	120	6	3.74	1000	4700	2700K	80	75	25,000	Yes	Damp	25°	White		
	E26	12	93311925	LED12DP30RB927/40	120	6	3.6	1050	2200	2700K	90	75	25,000	Yes	Damp	40°	Black	CEC Title 20	
	E26	12	93107784	LED12DP30RB927/40	120	6	3.74	850	1700	2700K	90	75	25,000	Yes	Damp	40°	Black		
	E26	12	84395	LED12DP30RW927/40	120	6	3.74	850	1700	2700K	90	75	25,000	Yes	Damp	40°	White		
	E26	12	93311924	LED12DP30RW927/40	120	6	3.6	1050	2200	2700K	90	75	25,000	Yes	Damp	40°	White	CEC Title 20	
	E26	12	42134	LED12DP30RW827/40	120	6	3.74	1000	2200	2700K	80	75	25,000	Yes	Damp	40°	White		
	E26	12	93311926	LED12DP30RW930/25	120	6	3.6	1050	3900	3000K	90	75	25,000	Yes	Damp	25°	White	CEC Title 20	
	E26	12	84384	LED12DP30RW830/25	120	6	3.74	1050	4800	3000K	80	75	25,000	Yes	Damp	25°	White		
	E26	12	93311927	LED12DP30RW930/40	120	6	3.6	1050	2200	3000K	90	75	25,000	Yes	Damp	40°	White	CEC Title 20	
	E26	12	42131	LED12DP30RW830/40	120	6	3.74	1050	2400	3000K	80	75	25,000	Yes	Damp	40°	White		
<b>PAR30 Long Neck - Low Glare - Visual Comfort Lens</b>																			
PAR30L	E26	12	93312005	LED12DP30LRW927/25	120	6	4.7	1050	3800	2700K	90	75	25,000	Yes	Damp	25°	White	CEC Title 20	
	E26	12	84407	LED12DP3LRW927/40	120	6	4.72	850	1700	2700K	90	75	25,000	Yes	Damp	40°	White		
	E26	12	93312006	LED12DP30LRW927/40	120	6	4.7	1050	2200	2700K	90	75	25,000	Yes	Damp	40°	White	CEC Title 20	
	E26	12	42144	LED12DP3LRW827/40	120	6	4.72	1000	2200	2700K	80	75	25,000	Yes	Damp	40°	White		
	E26	12	84399	LED12DP3LRW930/25	120	6	4.72	900	3900	3000K	90	75	25,000	Yes	Damp	25°	White		
	E26	12	93312007	LED12DP30LRW930/25	120	6	4.7	1050	3900	3000K	90	75	25,000	Yes	Damp	25°	White	CEC Title 20	
	E26	12	93312008	LED12DP30LRW930/40	120	6	4.7	1050	2200	3000K	90	75	25,000	Yes	Damp	40°	White	CEC Title 20	
	E26	12	93316394	LED12DP30LRB930/40	120	6	4.7	1050	2200	3000K	90	75	25,000	Yes	Damp	40°	Black	CEC Title 20	
	E26	12	42137	LED12DP3LRW830/40	120	6	4.72	1050	2400	3000K	80	75	25,000	Yes	Damp	40°	White		

## Directional Lamps (PAR30 - Value)

Bulb Shape	Base Type	Watts	Order Code	Description	Volts	Carton Qty <sup>2</sup>	MOL (in)	Lumens (Initial)	CBCP	Color Temp. (Initial)	CRI	Wattage Replacement	Rated Life L70 (Hrs) <sup>1</sup>	Dim-mable	Location Rating <sup>3</sup>	Beam Angle	Housing Color	Additional Information	
<b>PAR30 - TIR Lens</b>																			
PAR30	E26	12	93153892	LED12DP30VOW830/25-4PK	120	16	3.66	850	3400	3000K	80	75	15,000	Yes	Wet	25°	White	4 pack	
<b>PAR30 Long Neck - TIR Lens</b>																			
PAR30L	E26	12	93153891	LED12DP30LVOW830/ 25-4PK	120	16	4.69	850	3400	3000K	80	75	15,000	Yes	Wet	25°	White	4 pack	

## Directional Lamps (PAR30 - High Output)

Bulb Shape	Base Type	Watts	Order Code	Description	Volts	Car-ton Qty <sup>2</sup>	MOL (in)	Lumens (Initial)	CBCP	Color Temp. (Initial)	CRI	Wattage Replacement	Rated Life L70 (Hrs) <sup>1</sup>	Dim-mable	Location Rating <sup>3</sup>	Beam Angle	Housing Color	Additional Information	
<b>PAR 30 Long Neck - High Output - Universal 120-277V</b>																			
PAR30HO	E26	18	75089	LED18P30LW83015	120-277	6	4.6	1800	15500	3000K	80	75	25,000	-	Damp	15°	White		
	E26	18	75091	LED18P30LW83025	120-277	6	4.6	1800	7000	3000K	80	75	25,000	-	Damp	25°	White		
	E26	18	75065	LED18P30LW93015	120-277	6	4.6	1400	12500	3000K	90	75	25,000	-	Damp	15°	White		
	E26	18	75078	LED18P30LW93025	120-277	6	4.6	1400	5000	3000K	90	75	25,000	-	Damp	25°	White		

<sup>1</sup> The life rating is based on the hours of operation the lamp will provide before reaching 70% of its original lumen output (L70)

<sup>2</sup> Minimum order quantity = Carton Qty

<sup>3</sup> UL 1993 Environmental Requirements for LED LAMPS

Damp Location - Exterior or interior location that is normally or periodically subject to condensation of moisture in, on, or adjacent to electrical equipment, including partially protected locations

Wet Location - Location in which water or other liquid can drip, splash, or flow on or against electrical equipment.

When installing outdoors, ensure the socket used is suitably Listed for use in Wet locations and socket gaskets provided by the manufacturer are correctly attached.

^ GE Lighting, a Savant company, lamp, distributed Current Lighting Solutions, LLC.

# LED Lamps - Directional



## Directional Lamps (PAR38 - Visual Comfort Lens)

Bulb Shape	Base Type	Watts	Order Code	Description	Volts	Carton Qty <sup>2</sup>	MOL (in)	Lumens (Initial)	CBCP	Color Temp. (Initial)	CRI	Wattage Replacement	Rated Life L70 (Hrs) <sup>1</sup>	Dimmable	Location Rating <sup>3</sup>	Beam Angle	Housing Color	Additional Information	
<b>PAR38 - Low Glare - Visual Comfort Lens</b>																			
PAR38	E26	12	93311944	LED12DP38ROW927/25	120	6	5.2	1050	5400	2700K	90	100	25,000	Yes	Wet	25°	White	CEC Title 20	
	E26	12	93311945	LED12DP38ROW927/40	120	6	5.2	1050	2300	2700K	90	100	25,000	Yes	Wet	40°	White	CEC Title 20	
	E26	12	92971	LED12D38W3827/40	120	6	5.31	1050	2300	2700K	81	100	25,000	Yes	Damp	40°	White		
	E26	12	93311946	LED12DP38ROW930/25	120	6	5.2	1050	5400	3000K	90	100	25,000	Yes	Wet	25°	White	CEC Title 20	
	E26	12	92972	LED12D38W3830/25	120	6	5.31	1050	5500	3000K	81	100	25,000	Yes	Damp	25°	White		
	E26	12	93311947	LED12DP38ROW930/40	120	6	5.2	1050	2300	3000K	90	100	25,000	Yes	Wet	40°	White	CEC Title 20	
	E26	12	92973	LED12D38OW3830/40	120	6	5.31	1050	2300	3000K	80	100	25,000	Yes	Wet	40°	White		
	E26	16	93313077	LED16DP38ROW930/15	120	6	5.2	1550	15000	3000K	90	120	25,000	Yes	Wet	15°	White	CEC Title 20	
	E26	16	93313079	LED16DP38ROW830/15	120	6	5.2	1800	18000	3000K	80	120	25,000	Yes	Wet	15°	White		
	E26	16	93313081	LED16DP38ROS830/15	120	6	5.2	1800	18000	3000K	80	120	25,000	Yes	Wet	15°	Silver		
	E26	18	92923	LED18DP38W3927/25	120	6	5.31	1250	4900	2700K	92	100	25,000	Yes	Damp	25°	White		
	E26	18	93311929	LED18DP38ROW927/25	120	6	5.2	1550	5800	2700K	90	120	25,000	Yes	Wet	25°	White	CEC Title 20	
	E26	18	92950	LED18D38OW3827/25	120	6	5.31	1550	5800	2700K	81	120	25,000	Yes	Wet	25°	White		
	E26	18	93311930	LED18DP38ROW927/40	120	6	5.2	1550	3700	2700K	90	150	25,000	Yes	Wet	40°	White	CEC Title 20	
	E26	18	92958	LED18D38OW3827/40	120	6	5.31	1550	3800	2700K	81	120	25,000	Yes	Wet	40°	White		
	E26	18	92961	LED18D38W3830/15	120	6	5.31	1750	20000	3000K	81	150	25,000	Yes	Damp	15°	White		
	E26	18	93096546	LED18D38S3830/15	120	6	5.31	1750	20000	3000K	80	150	25,000	Yes	Damp	15°	Silver		
	E26	18	93311932	LED18DP38ROB930/25	120	6	5.2	1550	6000	3000K	90	120	25,000	Yes	Wet	25°	Black	CEC Title 20	
	E26	18	93311931	LED18DP38ROW930/25	120	6	5.2	1550	6000	3000K	90	120	25,000	Yes	Wet	25°	White	CEC Title 20	
	E26	18	92963	LED18D38OW3830/25	120	6	5.31	1550	6000	3000K	81	120	25,000	Yes	Wet	25°	White		
	E26	18	93311933	LED18DP38ROS930/25	120	6	5.2	1550	6000	3000K	90	120	25,000	Yes	Wet	25°	Silver	CEC Title 20	
	E26	18	92934	LED18D38W3930/40	120	6	5.31	1350	3200	3000K	92	120	25,000	Yes	Damp	40°	White		
	E26	18	93311934	LED18DP38ROW930/40	120	6	5.2	1550	3800	3000K	90	150	25,000	Yes	Wet	40°	White	CEC Title 20	
	E26	18	93316388	LED18DP38ROB930/40	120	6	5.2	1550	3800	3000K	90	150	25,000	Yes	Wet	40°	Black	CEC Title 20	
	E26	18	92967	LED18D38OW3830/40	120	6	5.31	1550	4000	3000K	81	150	25,000	Yes	Wet	40°	White		
	E26	18	93311935	LED18DP38ROW935/25	120	6	5.2	1700	6500	3500K	90	120	25,000	Yes	Wet	25°	White	CEC Title 20	
	E26	18	85085	LED18D38OW3835/25	120	6	5.31	1700	6500	3500K	81	120	25,000	Yes	Wet	25°	White		
	E26	18	93311936	LED18DP38ROW935/40	120	6	5.2	1700	4200	3500K	90	150	25,000	Yes	Wet	40°	White	CEC Title 20	
	E26	18	87917	LED18D38OW3835/40	120	6	5.31	1700	4400	3500K	81	150	25,000	Yes	Wet	40°	White		
	E26	18	93311937	LED18DP38ROW940/25	120	6	5.2	1700	6500	4000K	90	120	25,000	Yes	Wet	25°	White	CEC Title 20	
	E26	18	93171	LED18D38OW3840/25	120	6	5.31	1700	6500	4000K	81	120	25,000	Yes	Wet	25°	White		
	E26	18	93311938	LED18DP38ROW940/40	120	6	5.2	1700	4200	4000K	90	150	25,000	Yes	Wet	40°	White	CEC Title 20	
	E26	18	93172	LED18D38OW3840/40	120	6	5.31	1700	4400	4000K	81	150	25,000	Yes	Wet	40°	White		
	E26	18	93311939	LED18DP38ROW950/25	120	6	5.2	1700	6500	5000K	90	120	25,000	Yes	Wet	25°	White	CEC Title 20	
	E26	18	93311940	LED18DP38ROW950/40	120	6	5.2	1700	4200	5000K	90	150	25,000	Yes	Wet	40°	White	CEC Title 20	

## Directional Lamps (PAR38 - High Output)

Bulb Shape	Base Type	Watts	Order Code	Description	Volts	Carton Qty <sup>2</sup>	MOL (in)	Lumens (Initial)	CBCP	Color Temp. (Initial)	CRI	Wattage Replacement	Rated Life L70 (Hrs) <sup>1</sup>	Dimmable	Location Rating <sup>3</sup>	Beam Angle	Housing Color	Additional Information	
<b>PAR 38 - High Output - TIR Lens - Smooth Housing</b>																			
PAR38	E26	27	93314739	LED27DP38OW830/15	120	6	5.3	3100	20000	3000K	80	250	25,000	Yes	Wet	15°	White		
	E26	27	93314751	LED27DP38OW830/25	120	6	5.3	3100	10000	3000K	80	250	25,000	Yes	Wet	25°	White		
	E26	27	93314753	LED27DP38OW830/40	120	6	5.3	3100	5000	3000K	80	250	25,000	Yes	Wet	40°	White		
	E26	27	93314755	LED27DP38OW835/15	120	6	5.3	3100	20000	3500K	80	250	25,000	Yes	Wet	15°	White		
	E26	27	93314757	LED27DP38OW835/25	120	6	5.3	3100	10000	3500K	80	250	25,000	Yes	Wet	25°	White		
	E26	27	93314759	LED27DP38OW835/40	120	6	5.3	3100	5000	3500K	80	250	25,000	Yes	Wet	40°	White		
<b>PAR 38 - High Output - TIR Lens - Finned Heat Sink</b>																			
PAR38	E26	32	75447	LED32DP38W830/15	120	6	5.12	3000	26000	3000K	82	250	25,000	Yes	Wet	15°	White		
	E26	32	88801	LED32DP38W830/25	120	6	5.12	3000	13000	3000K	80	250	25,000	Yes	Wet	25°	White		
	E26	32	88810	LED32DP38W830/40	120	6	5.12	3000	6000	3000K	80	250	25,000	Yes	Wet	40°	White		
	E26	32	30233	LED32DP38W835/15	120	6	5.12	3100	25000	3500K	80	250	25,000	Yes	Wet	15°	White		
	E26	32	30237	LED32DP38W835/25	120	6	5.12	3100	13000	3500K	80	250	25,000	Yes	Wet	25°	White		
	E26	32	30239	LED32DP38W835/40	120	6	5.12	3100	6000	3500K	80	250	25,000	Yes	Wet	40°	White		
	E26	32	20109	LED32P38W830/15	120-277	6	5.12	3000	25000	3000K	80	250	25,000	-	Wet	15°	White		
	E26	32	20130	LED32P38W830/25	120-277	6	5.12	3000	13000	3000K	80	250	25,000	-	Wet	25°	White		
	E26	32	20137	LED32P38W830/40	120-277	6	5.12	3000	6000	3000K	80	250	25,000	-	Wet	40°	White		

## Directional Lamps (PAR38 - Value)

Bulb Shape	Base Type	Watts	Order Code	Description	Volts	Carton Qty <sup>2</sup>	MOL (in)	Lumens (Initial)	CBCP	Color Temp. (Initial)	CRI	Wattage Replacement	Rated Life L70 (Hrs) <sup>1</sup>	Dimmable	Location Rating <sup>3</sup>	Beam Angle	Housing Color	Additional Information	
<b>PAR38 - TIR Lens</b>																			
	E26	15	93153880	LED15DP38VOW830/35-4PK	120	16	5.31	1300	2300	3000K	80	90	15,000	Yes	Wet	35°	White	4 pack	

<sup>1</sup> The life rating is based on the hours of operation the lamp will provide before reaching 70% of its original lumen output (L70)

<sup>2</sup> Minimum order quantity = Carton Qty

<sup>3</sup> UL 1993 Environmental Requirements for LED LAMPS

Damp Location - Exterior or interior location that is normally or periodically subject to condensation of moisture in, on, or adjacent to electrical equipment, including partially protected locations

Wet Location - Location in which water or other liquid can drip, splash, or flow on or against electrical equipment

When installing outdoors, ensure the socket used is suitably Listed for use in Wet locations and socket gaskets provided by the manufacturer are correctly attached.

# LED Lamps – Directional



## LED Lamps – MR16s

LED MR16 lamps are the perfect solution for high output in decorative lighting applications. The lamps are dimmable, long-lasting and available in a variety of beam angles and color temperatures.

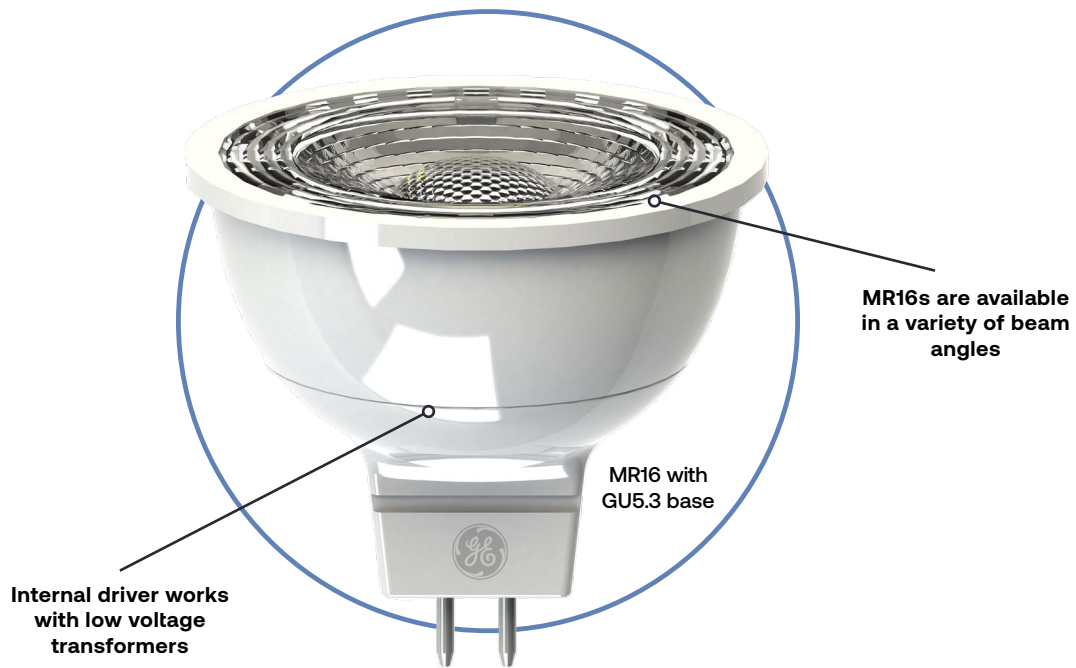

## Lamp Drawings (not drawn to scale)

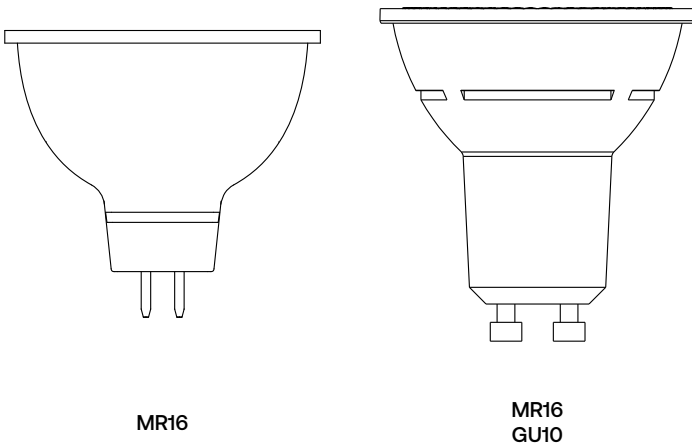

# LED Lamps - Directional



## Catalog Logic:

### Bulb Shape:

Bulb shape followed by its size (the maximum diameter of the bulb expressed in eighths of an inch).

### Watts:

Energy Used (as defined by FTC Lamp Label Rules)

### Lumens:

Light output (as defined by FTC Lamp Label Rules)

### Color Temperature (K):

A measure of the visual "warmth" or "coolness" of the light from the lamp. The higher the value, the whiter or "cooler" the light appears.

### Color Rendering Index (CRI or R):

An indication of the ability of the lamp to render object colors in a normal natural way. The higher the number (0-100), the better the color appearance.

**Wattage Replacement:**  
Wattage of Traditional Lamp the LED Lamp is meant to replace

**Dimmable:**  
Indicates whether a lamp is dimmable or not

**Rated Life L70:**  
Hours of operation the lamp will provide before reaching 70% of its original lumen output

**Location Rating:**  
Location Rating as defined for LED Lamps by UL 1993

**Beam Angle:**  
Degrees

**Additional Information:**  
Typical application and/or other important information

**Housing Color:**  
Color of lamp body

**Base Type:**  
ANSI Base

**Order Code:**  
Use the order code when ordering to ensure that you receive the exact product you require

**Description:**  
Lamp Model Description

**Carton Quantity:**  
Number of lamps packed in a carton

**MOL (in):**  
Maximum Overall Length in inches

**Volts:**  
Lamp data is based on operation at rated voltage

**CBCP:**  
Center Beam Candle Power

Bulb Shape	Base Type	Watts	Order Code	Description	Volts	Carton Qty <sup>2</sup>	MOL (In)	Lumens (Initial)	CBCP	Color Temp (Initial)	CRI	Wattage Replacement	Rated Life L70 (Hrs) <sup>1</sup>	Dimmable	Location Rating <sup>3</sup>	Beam Angle	Housing Color	Additional Information <sup>^</sup>	
<b>12 Volt AC/DC MR16</b>																			
GU5.3	6.5	6.5	75155	LED6.5DMR16W82715	12	6	1.87	500	4900	2700K	80	50	25,000	Yes	Damp	15°	White		

## LED6.5DMR16W82715

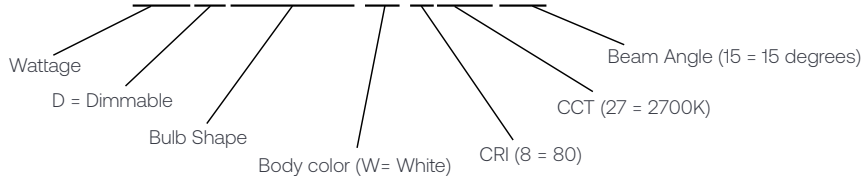

## Directional Lamps (MR16-GU10)

Bulb Shape	Base Type	Watts	Order Code	Description	Volts	Carton Qty <sup>2</sup>	MOL (In)	Lumens (Initial)	CBCP	Color Temp (Initial)	CRI	Wattage Replacement	Rated Life L70 (Hrs) <sup>1</sup>	Dimmable	Location Rating <sup>3</sup>	Beam Angle	Housing Color	Additional Information <sup>^</sup>	
<b>12 Volt AC/DC MR16</b>																			
GU5.3	6.5	6.5	75155	LED6.5DMR16W82715	12	6	1.87	500	4900	2700K	80	50	25,000	Yes	Damp	15°	White		
GU5.3	6.5	6.5	75153	LED6.5DMR16W83015	12	6	1.87	520	4900	3000K	80	50	25,000	Yes	Damp	15°	White		
GU5.3	6.5	6.5	75158	LED6.5DMR16W84015	12	6	1.87	550	5000	4000K	80	50	25,000	Yes	Damp	15°	White		
GU5.3	6.5	6.5	93226	LED6.5DMR16W82725	12	6	1.79	500	2350	2700K	80	50	25,000	Yes	Damp	25°	White		
GU5.3	6.5	6.5	93222	LED6.5DMR16W83025	12	6	1.79	520	2350	3000K	80	50	25,000	Yes	Damp	25°	White		
GU5.3	6.5	6.5	93228	LED6.5DMR16W84025	12	6	1.79	550	2400	4000K	80	50	25,000	Yes	Damp	25°	White		
GU5.3	6.5	6.5	93227	LED6.5DMR16W82735	12	6	1.79	500	1350	2700K	80	50	25,000	Yes	Damp	35°	White		
GU5.3	6.5	6.5	93097010	LED6.5DMR16B82735	12	6	1.79	500	1350	2700K	80	50	25,000	Yes	Damp	35°	Black		
GU5.3	6.5	6.5	93223	LED6.5DMR16W83035	12	6	1.79	520	1350	3000K	80	50	25,000	Yes	Damp	35°	White		
GU5.3	6.5	6.5	93229	LED6.5DMR16W84035	12	6	1.79	550	1400	4000K	80	50	25,000	Yes	Damp	35°	White		
GU5.3	7	7	21359	LED7MRX16R930/10	12	6	2.01	350	8000	3000K	95	50	25,000	-	Damp	10°	White	Reveal	
<b>Value 12 Volt AC/DC MR16</b>																			
GU5.3	4.5	4.5	34560	LED4.5DMR1682735	12	6	1.78	380	1000	2700K	80	35	25,000	Yes	Dry	35°	White		
GU5.3	4.5	4.5	34561	LED4.5DMR1683035	12	6	1.78	400	1000	3000K	80	35	25,000	Yes	Dry	35°	White		
GU5.3	4.5	4.5	34563	LED4.5DMR1684035	12	6	1.78	400	1100	4000K	80	35	25,000	Yes	Dry	35°	White		
GU5.3	6.5	6.5	34606	LED6.5DMR1682725	12	6	1.78	500	2350	2700K	80	50	25,000	Yes	Dry	25°	White		
GU5.3	6.5	6.5	34607	LED6.5DMR1682735	12	6	1.78	500	1350	2700K	80	50	25,000	Yes	Dry	35°	White		
GU5.3	6.5	6.5	34611	LED6.5DMR1683025	12	6	1.78	530	2350	3000K	80	50	25,000	Yes	Dry	25°	White		
GU5.3	6.5	6.5	34625	LED6.5DMR1683035	12	6	1.78	530	1350	3000K	80	50	25,000	Yes	Dry	35°	White		
<b>120V GU10</b>																			
GU10	4	4	93305604	LED4D/GU10W830/35-6PK	120	24	2.1	320	370	3000K	80	35	25,000	Yes	Damp	35°	White	6 pack	
GU10	5.5	5.5	93305605	LED5D/GU10W830/35-6PK	120	24	2.1	500	595	3000K	80	50	25,000	Yes	Damp	35°	White	6 pack	

<sup>^</sup> Check dimmer and transformer compatibility at LED.com/dimming

<sup>1</sup> The life rating is based on the hours of operation the lamp will provide before reaching 70% of its original lumen output (L70)

<sup>2</sup> Minimum order quantity = Carton Qty

<sup>3</sup> UL 1993 Environmental Requirements for LED LAMPS

Damp Location - Exterior or interior location that is normally or periodically subject to condensation of moisture in, on, or adjacent to electrical equipment, including partially protected locations

Dry Location - Location not normally subject to dampness, but may include a location subject to temporary dampness (i.e., building under construction, provided ventilation is adequate to prevent an accumulation of moisture)

# LED Lamps - Directional



## LED Lamps - RS Cans

RS Cans make downlight retrofits easy, with a medium base pigtail. Use the existing socket for power and provide a finished look to the ceiling without having to replace the existing fixture.



### Selectable SpectraChoice™ RS Cans

The new SpectraChoice™ Selectable RS Can Downlights are the perfect solution to give an updated look to ceilings with recessed lighting.

Make color temperature selections easily at any time with an integrated switch, no tools required.



Medium (E26) base pigtail for easy installation

Quick disconnect if E26 base is not needed

White trim provides a finished look to the ceiling

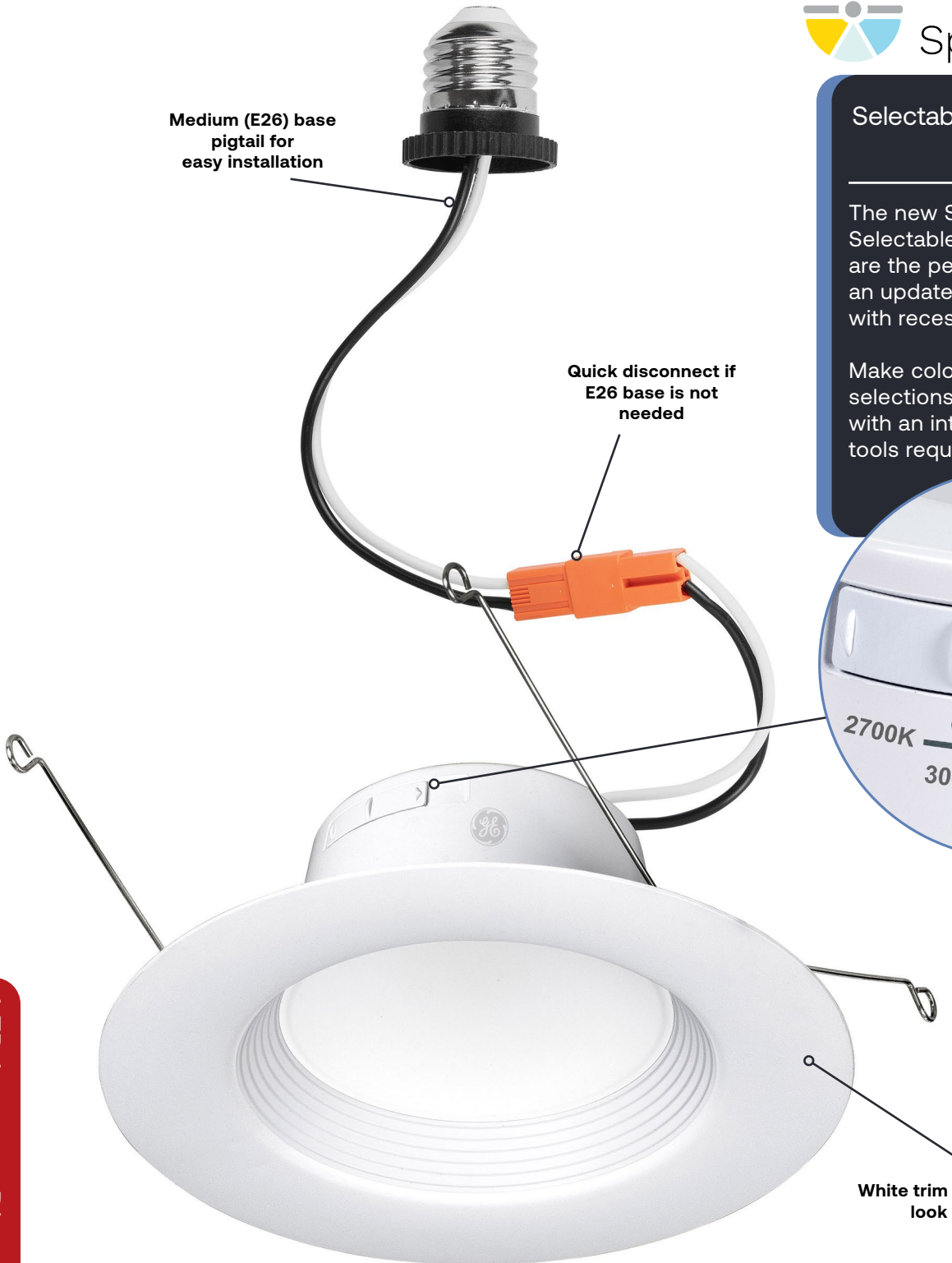

# LED Lamps - Directional



## Catalog Logic:

### Bulb Shape:

Bulb shape followed by its size (the maximum diameter of the bulb expressed in eighths of an inch).

**Watts:** Energy Used (as defined by FTC Lamp Label Rules)

**Lumens:** Light output (as defined by FTC Lamp Label Rules)

**MOL (in):** Maximum Overall Length in inches

**Color Rendering Index (CRI or R):** An indication of the ability of the lamp to render object colors in a normal natural way. The higher the number (0-100), the better the color appearance.

**Wattage Replacement:** Wattage of Traditional Lamp the LED Lamp is meant to replace

**Dimmable:** Indicates whether a lamp is dimmable or not

**Additional Information:** Typical application and/or other important information

**Base Type:** ANSI Base

**Order Code:** Use the order code when ordering to ensure that you receive the exact product you require

**Volts:** Lamp data is based on operation at rated voltage

**Carton Quantity:** Number of lamps packed in a carton

**Color Temperature (K):** A measure of the visual "warmth" or "coolness" of the light from the lamp. The higher the value, the whiter or "cooler" the light appears.

**Rated Life L70:** Hours of operation the lamp will provide before reaching 70% of its original lumen output

**Location Rating:** Location Rating as defined for LED Lamps by UL 1993

**Description:** Lamp Model Description

Bulb Shape	Base Type	Watts	Order Code	Description	Volts	Carton Qty <sup>2</sup>	MOL (In)	Lumens (Initial)	Color Temp (Initial)	Wattage Replacement	Rated Life L70 (Hrs) <sup>1</sup>	Dimmable	Location Rating <sup>3</sup>	Additional Information	
RS Cans															
E26	8	93162554	LED8DRS4/9SC-4PK		120	16	2.4	700	2700/3000/4000/5000K	90	65	50,000	Yes	Damp	4" Can, Pigtail, Title 24-JA8, 4 pack

## LED8DRS6/9SC-4PK

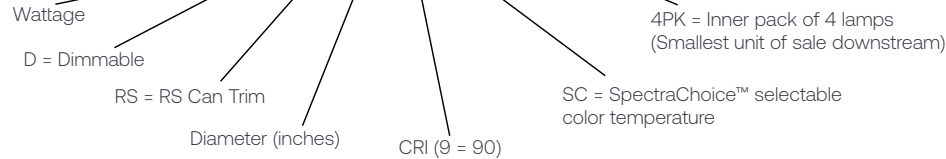

## Selectable SpectraChoice™ RS Cans

Bulb Shape	Base Type	Watts	Order Code	Description	Volts	Carton Qty <sup>2</sup>	MOL (In)	Lumens (Initial)	Selectable Color Temperature*	Wattage Replacement	Rated Life L70 (Hrs) <sup>1</sup>	Dimmable	Location Rating <sup>3</sup>	Additional Information	
Selectable RS Cans															
	E26	8	93162554	LED8DRS4/9SC-4PK	120	16	2.4	700	2700/3000/4000/5000K	90	65	50,000	Yes	Damp	4" Can, Pigtail, Title 24-JA8, 4 pack
	E26	8	93162555	LED8DRS6/9SC-4PK	120	16	2.8	700	2700/3000/4000/5000K	90	65	50,000	Yes	Damp	6" Can, Pigtail, Title 24-JA8, 4 pack
	E26	12	93162556	LED12DRS6/9SC-4PK	120	16	2.8	1100	2700/3000/4000/5000K	90	90	50,000	Yes	Damp	6" Can, Pigtail, Title 24-JA8, 4 pack

## RS Cans

Bulb Shape	Base Type	Watts	Order Code	Description	Volts	Carton Qty <sup>2</sup>	MOL (In)	Lumens (Initial)	Color Temp (Initial)	Wattage Replacement	Rated Life L70 (Hrs) <sup>1</sup>	Dimmable	Location Rating <sup>3</sup>	Additional Information	
RS Cans															
	E26	8	19888	LED8DRS6/827	120	12	4.96	700	2700K	80	65	50,000	Yes	Damp	6" Can, Pigtail Attachment
	E26	8	19908	LED8DRS6/830	120	12	4.96	700	3000K	80	65	50,000	Yes	Damp	6" Can, Pigtail Attachment

<sup>1</sup> The life rating is based on the hours of operation the lamp will provide before reaching 70% of its original lumen output (L70)

<sup>2</sup> Minimum order quantity = Carton Qty

<sup>3</sup> UL 1993 Environmental Requirements for LED LAMPS

Damp Location - Exterior or interior location that is normally or periodically subject to condensation of moisture in, on, or adjacent to electrical equipment, including partially protected locations

\* Default color temperature setting is 3000K.

# LED Lamps – Directional



## LED Lamps – Reflectors

Current offers LED reflector lamps for all of your recessed can and downlighting application needs in the restaurant, hospitality and property management sectors.



# LED Lamps - Directional



## Catalog Logic:

### Bulb Shape:

Bulb shape followed by its size (the maximum diameter of the bulb expressed in eighths of an inch).

**Watts:**  
Energy Used (as defined by FTC Lamp Label Rules)

**Lumens:**  
Light output (as defined by FTC Lamp Label Rules)

**Color Temperature (K):**  
A measure of the visual "warmth" or "coolness" of the light from the lamp. The higher the value, the whiter or "cooler" the light appears.

**Color Rendering Index (CRI or R):**  
An indication of the ability of the lamp to render object colors in a normal natural way. The higher the number (0-100), the better the color appearance.

**MOL (in):**  
Maximum Overall Length in inches

**CBCP:**  
Center Beam Candle Power

**Wattage Replacement:**  
Wattage of Traditional Lamp the LED Lamp is meant to replace

**Location Rating:**  
Location Rating as defined for LED Lamps by UL 1993

**Order Code:**  
Use the order code when ordering to ensure that you receive the exact product you require

**Carton Quantity:**  
Number of lamps packed in a carton

**Volts:**  
Lamp data is based on operation at rated voltage

**Dimmable:**  
Indicates whether a lamp is dimmable or not

**Description:**  
Lamp Model Description

**Rated Life L70:**  
Hours of operation the lamp will provide before reaching 70% of its original lumen output

**Additional Information:**  
Typical application and/or other important information

Bulb Shape	Base Type	Watts	Order Code	Description	Volts	Carton Qty <sup>2</sup>	MOL (In)	Lumens (Initial)	Color Temp (Initial)	CRI	Wattage Replacement	Rated Life L70 (Hrs) <sup>1</sup>	Dimmable	Location Rating <sup>3</sup>	Additional Information
R20	E26	5	45545	LED5DR209CSW	120	6	4.0	450	2700K	92	45	15,000	Yes	Damp	Frosted, White body <sup>^</sup>

## LED13DBR40/827

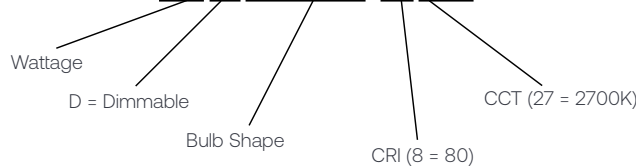

## Reflector Lamps

Bulb Shape	Base Type	Watts	Order Code	Description	Volts	Carton Qty <sup>2</sup>	MOL (In)	Lumens (Initial)	Color Temp (Initial)	CRI	Wattage Replacement	Rated Life L70 (Hrs) <sup>1</sup>	Dimmable	Location Rating <sup>3</sup>	Additional Information
	E26	5.5	93311895	LED5DR20/927	120	6	4.0	500	2700K	90	45	15,000	Yes	Damp	Frosted, White body, CEC Title 20
	E26	5.5	93311896	LED5DR20/930	120	6	4.0	500	3000K	90	45	15,000	Yes	Damp	Frosted, White body, CEC Title 20
	E26	5	45545	LED5DR209CSW	120	6	4.0	450	2700K	92	45	15,000	Yes	Damp	Frosted, White body <sup>^</sup>
	E26	7	38268	LED7DR20/827	120	6	4.0	525	2700K	80	45	15,000	Yes	Damp	Frosted, White body
	E26	7	43233	LED7DR20/830	120	6	4.0	525	3000K	80	45	15,000	Yes	Damp	Frosted, White body
	E26	7	38273	LED7DR20/850	120	6	4.0	525	5000K	80	45	15,000	Yes	Damp	Frosted, White body
	E26	8	93305498	LED8DBR30/927-6PK	120	24	5.4	650	2700K	90	65	15,000	Yes	Damp	White body, 6 pack, CEC Title 20
	E26	8	93305499	LED8DBR30/930-6PK	120	24	5.4	650	3000K	90	65	15,000	Yes	Damp	White body, 6 pack, CEC Title 20
	E26	8	93305510	LED8DBR30/940-6PK	120	24	5.4	650	4000K	90	65	15,000	Yes	Damp	White body, 6 pack, CEC Title 20
	E26	8	93305512	LED8DBR30/950-6PK	120	24	5.4	650	5000K	90	65	15,000	Yes	Damp	White body, 6 pack, CEC Title 20
	E26	10	68160	LED10DR303/827W	120	6	5.4	700	2700K	80	65	25,000	Yes	Damp	Frosted, White body
	E26	10	68161	LED10DR303/830W	120	6	5.4	700	3000K	80	65	25,000	Yes	Damp	Frosted, White body
	E26	10	69107	LED10DR303/850W	120	6	5.4	700	5000K	80	65	25,000	Yes	Damp	Frosted, White body
	E26	12	93311897	LED12DBR40/927	120	6	6.4	1050	2700K	90	65	15,000	Yes	Damp	Frosted, White body, CEC Title 20
	E26	12	93311898	LED12DBR40/930	120	6	6.4	1050	3000K	90	65	15,000	Yes	Damp	Frosted, White body, CEC Title 20
E26	12	93311899	LED12DBR40/950	120	6	6.4	1050	5000K	90	65	15,000	Yes	Damp	Frosted, White body, CEC Title 20	

<sup>1</sup> The life rating is based on the hours of operation the lamp will provide before reaching 70% of its original lumen output (L70)

<sup>2</sup> Minimum order quantity = Carton Qty

<sup>3</sup> UL 1993 Environmental Requirements for LED LAMPS

Damp Location - Exterior or interior location that is normally or periodically subject to condensation of moisture in, on, or adjacent to electrical equipment, including partially protected locations

<sup>^</sup> GE Lighting, a Savant company, lamp, distributed Current Lighting Solutions, LLC.

# LED Lamps - General Purpose



## Catalog Logic:

### Bulb Shape:

Bulb shape followed by its size (the maximum diameter of the bulb expressed in eighths of an inch).

Bulb Shape	Base Type	Watts	Order Code	Description	Volts	Carton Qty <sup>2</sup>	MOL (in)	Lumens (Initial)	Color Temp. (Initial)	CRI	Wattage Replacement	Rated Life L70 (Hrs) <sup>3</sup>	Dimmable	Location Rating <sup>3</sup>	Additional Information
A19	E26	10	93156450	LED10DA19/827/E-4PK	120	24	4.3	800	2700K	80	60	15,000	Yes	Damp, Enclosed	White, 4 pack

## LED10DA19/827/E-4PK



## Lamp Drawings (not drawn to scale)

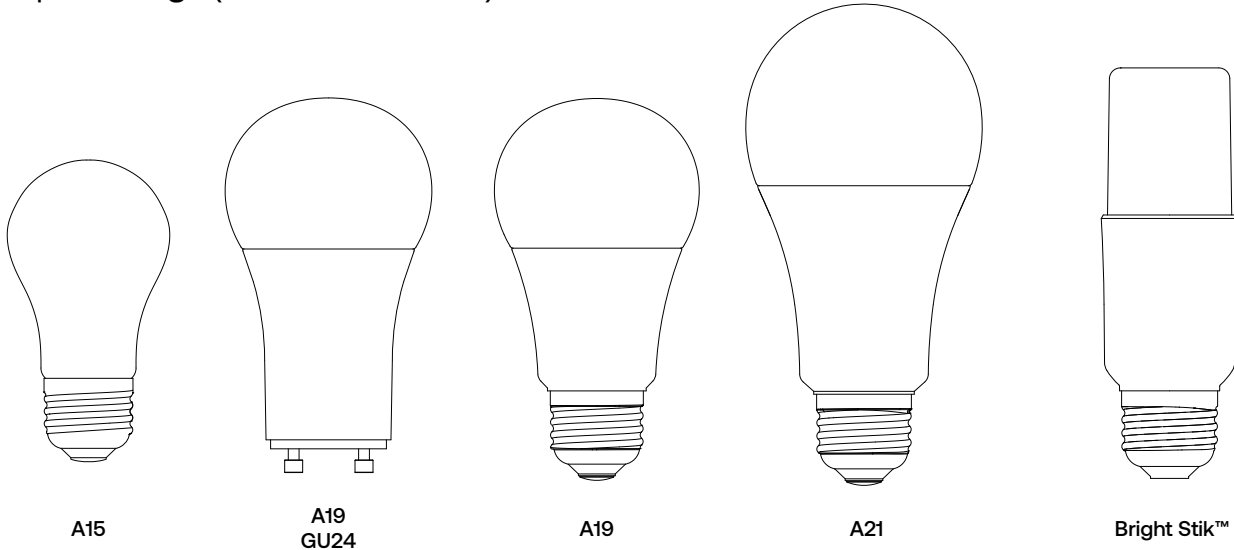

A15

A19  
GU24

A19

A21

Bright Stik™



# LED Lamps – General Purpose

## LED Lamps – SpectraChoice™ A-Line Lamps (Dimmable)

SpectraChoice™ A-line dimmable lamps feature built-in switches to select color temperature. These lamps are offered in 40, 60, 75 & 100W incandescent equivalent lumen levels. Four lamps can cover the vast majority of A-line applications, providing a great opportunity to reduce inventory and simplify BOMs.

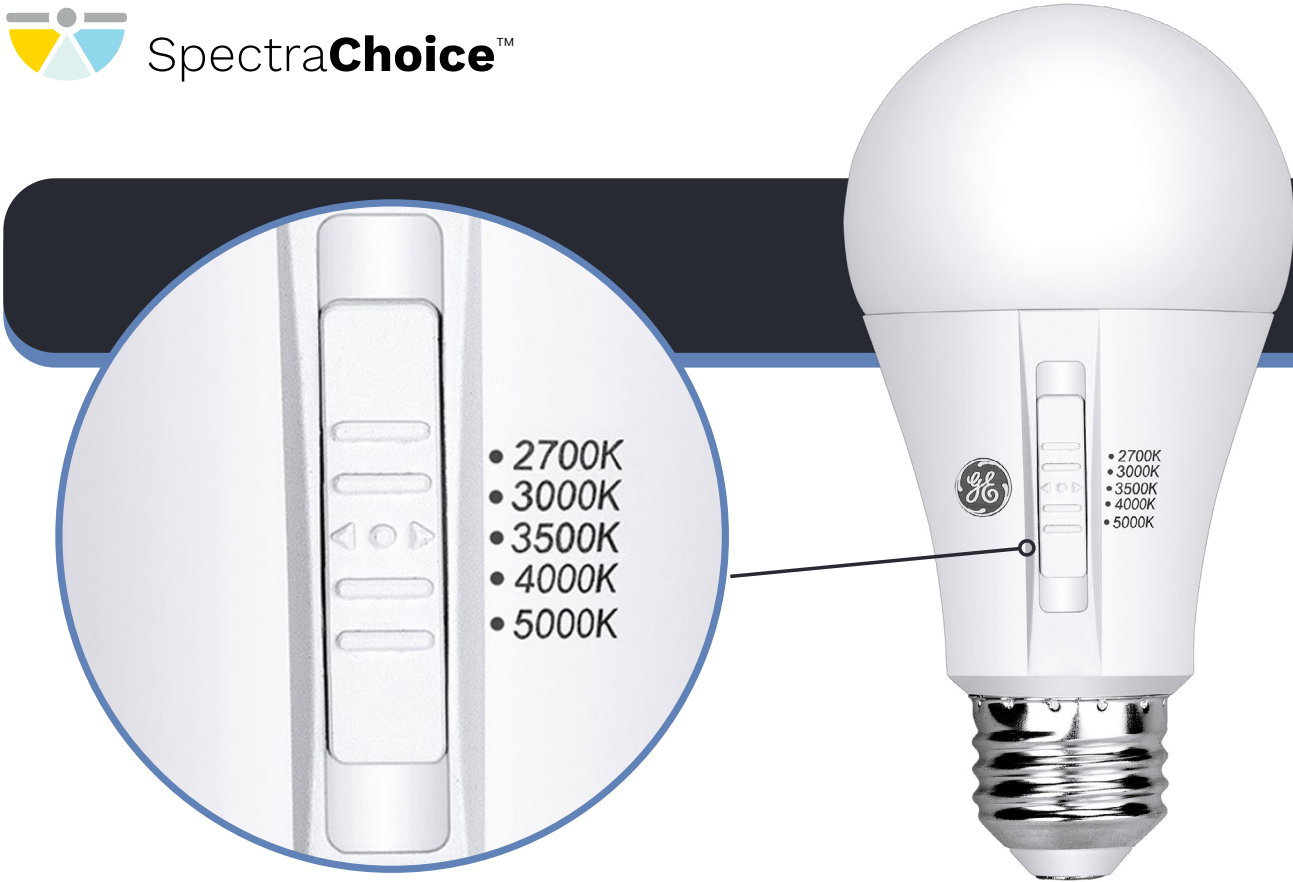

## Selectable SpectraChoice™ A-Line Lamps (Dimmable)

Bulb Shape	Base Type	Watts	Order Code	Description	Volts	Carton Qty <sup>2</sup>	MOL (In)	Lumens (Initial) <sup>5</sup>	Selectable Color Temp. (Initial)*	CRI	Wattage Replacement	Rated Life L70 (Hrs) <sup>1</sup>	Dimmable	Location Rating <sup>3</sup>	Additional Information
A-Line SpectraChoice™ Selectable Color Temperature									2700K* 3000K 3500K 4000K 5000K						
A19	E26	6	93313531	LED6DA19/9SC/E	120	24	4.3	480	2700K* 3000K 3500K 4000K 5000K	90	40	15,000	Yes	Damp, Enclosed	White, CEC Title 20
A19	E26	10	93313549	LED10DA19/9SC/E	120	24	4.3	800	2700K* 3000K 3500K 4000K 5000K	90	60	15,000	Yes	Damp, Enclosed	White, CEC Title 20
A19	E26	13	93313543	LED13DA19/9SC	120	24	4.7	1100	2700K* 3000K 3500K 4000K 5000K	90	75	15,000	Yes	Damp	White, CEC Title 20
A19	E26	15	93313537	LED15DA19/9SC	120	24	4.7	1600	2700K* 3000K 3500K 4000K 5000K	90	100	15,000	Yes	Damp	White, CEC Title 20

<sup>1</sup> The life rating is based on the hours of operation the lamp will provide before reaching 70% of its original lumen output (L70)

<sup>2</sup> Minimum order quantity = Carton Qty

<sup>3</sup> UL 1993 Environmental Requirements for LED LAMPS

Damp Location – Exterior or interior location that is normally or periodically subject to condensation of moisture in, on, or adjacent to electrical equipment, including partially protected locations

\* Default color temperature setting is 2700K

# LED Lamps - General Purpose



## A-Line Lamps (Dimmable)

Bulb Shape	Base Type	Watts	Order Code	Description	Volts	Carton Qty <sup>2</sup>	MOL (in)	Lumens (Initial)	Color Temp. (Initial)	CRI	Wattage Replacement	Rated Life L70 (Hrs) <sup>1</sup>	Dimmable	Location Rating <sup>3</sup>	Additional Information
<b>A15</b>															
A15	E26	3.5	93312022	LED4DFA15-W/927	120	12	3.5	300	2700K	90	40	15,000	Yes	Damp	All Glass, White, CEC Title 20
	E26	3.5	93142809	LED4DFA15-C-2PK	120	12	3.5	300	2700K	80	40	15,000	Yes	Damp	All Glass, Clear, 2 pack
	E26	3.5	93142810	LED4DFA15-W-2PK	120	12	3.5	300	2700K	80	40	15,000	Yes	Damp	All Glass, White, 2 pack
<b>A19</b>															
A19	E26	4.5	37669	LED5DAGCSW-2P 120	120	12	4.4	450	2700K	80	40	15,000	Yes	Damp	All Glass, Clear, 2 pack <sup>^</sup>
	E26	6	93156446	LED6DA19/827/E-4PK	120	24	4.3	480	2700K	80	40	15,000	Yes	Damp, Enclosed	White, 4 pack
	E26	6	93156447	LED6DA19/830/E-4PK	120	24	4.3	480	3000K	80	40	15,000	Yes	Damp, Enclosed	White, 4 pack
	E26	6	93156448	LED6DA19/840/E-4PK	120	24	4.3	480	4000K	80	40	15,000	Yes	Damp, Enclosed	White, 4 pack
	E26	6	93156449	LED6DA19/850/E-4PK	120	24	4.3	480	5000K	80	40	15,000	Yes	Damp, Enclosed	White, 4 pack
	E26	10	93156450	LED10DA19/827/E-4PK	120	24	4.3	800	2700K	80	60	15,000	Yes	Damp, Enclosed	White, 4 pack
	E26	10	93156531	LED10DA19/830/E-4PK	120	24	4.3	800	3000K	80	60	15,000	Yes	Damp, Enclosed	White, 4 pack
	E26	10	93156532	LED10DA19/840/E-4PK	120	24	4.3	800	4000K	80	60	15,000	Yes	Damp, Enclosed	White, 4 pack
	E26	10	93156533	LED10DA19/850/E-4PK	120	24	4.3	800	5000K	80	60	15,000	Yes	Damp, Enclosed	White, 4 pack
	E26	12	93156534	LED12DA19/827/E-4PK	120	24	4.7	1100	2700K	80	75	15,000	Yes	Damp, Enclosed	White, 4 pack
	E26	12	93156539	LED12DA19/830/E-4PK	120	24	4.7	1100	3000K	80	75	15,000	Yes	Damp, Enclosed	White, 4 pack
	E26	12	93156536	LED12DA19/840/E-4PK	120	24	4.7	1100	4000K	80	75	15,000	Yes	Damp, Enclosed	White, 4 pack
	E26	12	93156537	LED12DA19/850/E-4PK	120	24	4.7	1100	5000K	80	75	15,000	Yes	Damp, Enclosed	White, 4 pack
	E26	15	93156538	LED15DA19/827-4PK	120	24	4.7	1600	2700K	80	100	15,000	Yes	Damp	White, 4 pack
	E26	15	93156539	LED15DA19/830-4PK	120	24	4.7	1600	3000K	80	100	15,000	Yes	Damp	White, 4 pack
	E26	15	93156540	LED15DA19/840-4PK	120	24	4.7	1600	4000K	80	100	15,000	Yes	Damp	White, 4 pack
	E26	15	93156541	LED15DA19/850-4PK	120	24	4.7	1600	5000K	80	100	15,000	Yes	Damp	White, 4 pack

## A-Line Lamps 90 CRI (Dimmable)

Bulb Shape	Base Type	Watts	Order Code	Description	Volts	Carton Qty <sup>2</sup>	MOL (in)	Lumens (Initial)	Color Temp. (Initial)	CRI	Wattage Replacement	Rated Life L70 (Hrs) <sup>1</sup>	Dimmable	Location Rating <sup>3</sup>	Additional Information
<b>A19</b>															
A19	E26	5.5	93305532	LED6DA19/927/E-4PK	120	24	4.3	450	2700K	90	40	15,000	Yes	Damp, Enclosed	White, 4 pack, CEC Title 20
	E26	5.5	93305533	LED6DA19/950/E-4PK	120	24	4.3	450	5000K	90	40	15,000	Yes	Damp, Enclosed	White, 4 pack, CEC Title 20
	E26	10	93305534	LED10DA19/927/E-4PK	120	24	4.3	800	2700K	90	60	15,000	Yes	Damp, Enclosed	White, 4 pack, CEC Title 20
	E26	10	93305535	LED10DA19/950/E-4PK	120	24	4.3	800	5000K	90	60	15,000	Yes	Damp, Enclosed	White, 4 pack, CEC Title 20
	E26	13	93305536	LED13DA19/927-4PK	120	24	4.7	1100	2700K	90	75	15,000	Yes	Damp	White, 4 pack, CEC Title 20
	E26	13	93305537	LED13DA19/950-4PK	120	24	4.7	1100	5000K	90	75	15,000	Yes	Damp	White, 4 pack, CEC Title 20
	E26	15	93305538	LED15DA19/927-4PK	120	24	4.7	1600	2700K	90	100	15,000	Yes	Damp	White, 4 pack, CEC Title 20
	E26	15	93305539	LED15DA19/950-4PK	120	24	4.7	1600	5000K	90	100	15,000	Yes	Damp	White, 4 pack, CEC Title 20

## A-Line Lamps (High Output)

Bulb Shape	Base Type	Watts	Order Code	Description	Volts	Carton Qty <sup>2</sup>	MOL (in)	Lumens (Initial)	Color Temp. (Initial)	CRI	Wattage Replacement	Rated Life L70 (Hrs) <sup>1</sup>	Dimmable	Location Rating <sup>3</sup>	Additional Information
<b>A21</b>															
A21	E26	22	93309224	LED22DA21/827	120	4	5.7	2610	2700K	80	150	15,000	Yes	Wet	White
	E26	22	93309225	LED22DA21/850	120	4	5.7	2610	5000K	80	150	15,000	Yes	Wet	White
	E26	23	93309226	LED23A21/827	120	4	5.7	3010	2700K	80	200	15,000	No	Wet	White
	E26	23	93309227	LED23A21/850	120	4	5.7	3010	5000K	80	200	15,000	No	Wet	White

<sup>1</sup> The life rating is based on the hours of operation the lamp will provide before reaching 70% of its original lumen output (L70)

<sup>2</sup> Minimum order quantity = Carton Qty

<sup>3</sup> UL 1993 Environmental Requirements for LED LAMPS

Damp Location - Exterior or interior location that is normally or periodically subject to condensation of moisture in, on, or adjacent to electrical equipment, including partially protected locations  
Wet Location - Location in which water or other liquid can drip, splash, or flow on or against electrical equipment.

When installing outdoors, ensure the socket used is suitably Listed for use in Wet locations and socket gaskets provided by the manufacturer are correctly attached.

<sup>^</sup> GE Lighting, a Savant company, lamp, distributed Current Lighting Solutions, LLC.

# LED Lamps - General Purpose



## A-Line Lamps (GU24)

Bulb Shape	Base Type	Watts	Order Code	Description	Volts	Carton Qty <sup>2</sup>	MOL (in)	Lumens (Initial)	Color Temp. (Initial)	CRI	Wattage Replacement	Rated Life L70 (Hrs) <sup>1</sup>	Dimmable	Location Rating <sup>3</sup>	Additional Information
<b>GU24 Base General Purpose A-Line Lamps</b>															
A19	GU24	10	93156542	LED10DA19/GU24/827-E-4PK	120	24	4.2	800	2700K	80	40	15,000	Yes	Damp, Enclosed	White, 4 pack
A19	GU24	15	93156543	LED15DA19/GU24/827-4PK	120	24	4.4	1600	2700K	80	100	15,000	Yes	Damp	White, 4 pack

## A-Line Lamps (3-Way)

Bulb Shape	Base Type	Watts	Order Code	Description	Volts	Carton Qty <sup>2</sup>	MOL (in)	Lumens (Initial)	Color Temp. (Initial)	CRI	Wattage Replacement	Rated Life L70 (Hrs) <sup>1</sup>	Dimmable	Location Rating <sup>3</sup>	Additional Information
<b>3-Way General Purpose A-Line Lamps</b>															
A19	E26d	4/9/13	93156602	LED13A19/30/100/827-4PK	120	24	4.7	400/980/1400	2700K	80	30/70/100	15,000	-	Damp	White, 4 pack
A21	E26d	5/12/17	93156603	LED17A21/50/150/827-4PK	120	24	5.3	650/1500/2155	2700K	80	50/100/150	15,000	-	Damp	White, 4 pack

## A-Line Lamps (Value)

Bulb Shape	Base Type	Watts	Order Code	Description	Volts	Carton Qty <sup>2</sup>	MOL (in)	Lumens (Initial)	Color Temp. (Initial)	CRI	Wattage Replacement	Rated Life L70 (Hrs) <sup>1</sup>	Dimmable	Location Rating <sup>3</sup>	Additional Information
<b>A19</b>															
A19	E26	5	93142977	LED5A19/827-4PK	120	24	4.3	450	2700K	80	40	10,000	-	Damp	White, 4 pack
A19	E26	5	93142978	LED5A19/830-4PK	120	24	4.3	450	3000K	80	40	10,000	-	Damp	White, 4 pack
A19	E26	5	93142979	LED5A19/840-4PK	120	24	4.3	450	4000K	80	40	10,000	-	Damp	White, 4 pack
A19	E26	5	93142980	LED5A19/850-4PK	120	24	4.3	450	5000K	80	40	10,000	-	Damp	White, 4 pack
A19	E26	9	93142981	LED9A19/827-4PK	120	24	4.3	760	2700K	80	60	10,000	-	Damp	White, 4 pack
A19	E26	9	93142982	LED9A19/830-4PK	120	24	4.3	760	3000K	80	60	10,000	-	Damp	White, 4 pack
A19	E26	9	93142983	LED9A19/840-4PK	120	24	4.3	760	4000K	80	60	10,000	-	Damp	White, 4 pack
A19	E26	9	93142984	LED9A19/850-4PK	120	24	4.3	760	5000K	80	60	10,000	-	Damp	White, 4 pack
<b>A21</b>															
A21	E26	11	93142985	LED11A21/827-4PK	120	24	5.2	1050	2700K	80	75	10,000	-	Damp	White, 4 pack
A21	E26	11	93142986	LED11A21/830-4PK	120	24	5.2	1050	3000K	80	75	10,000	-	Damp	White, 4 pack
A21	E26	11	93142987	LED11A21/840-4PK	120	24	5.2	1050	4000K	80	75	10,000	-	Damp	White, 4 pack
A21	E26	11	93142988	LED11A21/850-4PK	120	24	5.2	1050	5000K	80	75	10,000	-	Damp	White, 4 pack
A21	E26	15	93142989	LED15A21/827-4PK	120	24	5.2	1520	2700K	80	100	10,000	-	Damp	White, 4 pack
A21	E26	15	93142990	LED15A21/830-4PK	120	24	5.2	1520	3000K	80	100	10,000	-	Damp	White, 4 pack
A21	E26	15	93142991	LED15A21/840-4PK	120	24	5.2	1520	4000K	80	100	10,000	-	Damp	White, 4 pack
A21	E26	15	93142992	LED15A21/850-4PK	120	24	5.2	1520	5000K	80	100	10,000	-	Damp	White, 4 pack

## Bright Stik™

Bulb Shape	Base Type	Watts	Order Code	Description	Volts	Carton Qty <sup>2</sup>	MOL (in)	Lumens (Initial)	Color Temp. (Initial)	CRI	Wattage Replacement	Rated Life L70 (Hrs) <sup>1</sup>	Dimmable	Location Rating <sup>3</sup>	Additional Information
<b>Bright Stik™</b>															
Bright Stik™	E26	5.5	66256	LED5.5LS3/827	120	48	4.45	450	2700K	80	40	15,000	-	Damp	3 pack
Bright Stik™	E26	5.5	75177	LED5.5LS3/850	120	48	4.45	450	5000K	80	40	15,000	-	Damp	3 pack
Bright Stik™	E26	9	75184	LED9LS3/827	120	48	4.45	800	2700K	80	60	15,000	-	Damp	3 pack
Bright Stik™	E26	9	75588	LED9LS3/850	120	48	4.45	800	5000K	80	60	15,000	-	Damp	3 pack
Bright Stik™	E26	12	75590	LED12LS2/827	120	32	5.24	1250	2700K	80	75	15,000	-	Damp	2 pack
Bright Stik™	E26	12	75591	LED12LS2/850	120	32	5.24	1250	5000K	80	75	15,000	-	Damp	2 pack
Bright Stik™	E26	15	75593	LED15LS2/827	120	32	5.24	1700	2700K	80	100	15,000	-	Damp	2 pack
Bright Stik™	E26	15	75644	LED15LS2/850	120	32	5.24	1700	5000K	80	100	15,000	-	Damp	2 pack

<sup>1</sup> The life rating is based on the hours of operation the lamp will provide before reaching 70% of its original lumen output (L70)

<sup>2</sup> Minimum order quantity = Carton Qty

<sup>3</sup> UL 1993 Environmental Requirements for LED LAMPS

Damp Location - Exterior or interior location that is normally or periodically subject to condensation of moisture in, on, or adjacent to electrical equipment, including partially protected locations

# LED Lamps - General Purpose



## LED Lamps - Decorative

Decorative LED lamps feature LED "filaments" in glass bulbs, mimicking a traditional decorative lamp look. Various shapes, bases and wattages are available in clear and white finishes.

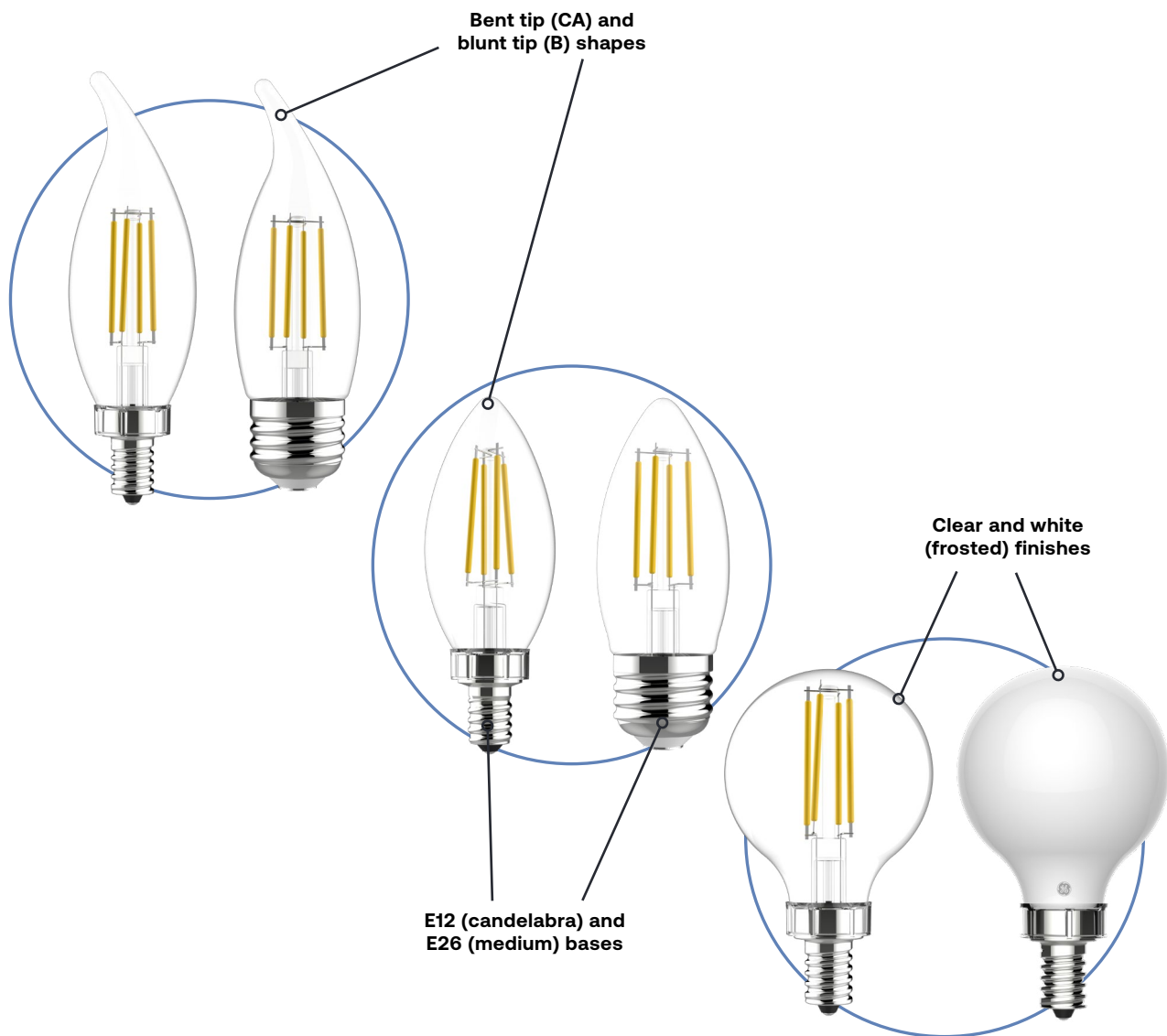

# LED Lamps - General Purpose



## Catalog Logic:

### Bulb Shape:

Bulb shape followed by its size (the maximum diameter of the bulb expressed in eighths of an inch).

**Watts:**  
Energy Used (as defined by FTC Lamp Label Rules)

**Description:**  
Lamp Model Description

**Lumens:**  
Light output (as defined by FTC Lamp Label Rules)

**MOL (in):**  
Maximum Overall Length in inches

**Carton Quantity:**  
Number of lamps packed in a carton

**Volts:**  
Lamp data is based on operation at rated voltage

### Color Rendering Index (CRI or R):

An indication of the ability of the lamp to render object colors in a normal natural way. The higher the number (0-100), the better the color appearance.

**Color Temperature (K):**  
A measure of the visual "warmth" or "coolness" of the light from the lamp. The higher the value, the whiter or "cooler" the light appears.

### Rated Life L70:

Hours of operation the lamp will provide before reaching 70% of its original lumen output

**Dimmable:**  
Indicates whether a lamp is dimmable or not

**Location Rating:**  
Location Rating as defined for LED Lamps by UL 1993

**Additional Information:**  
Typical application and/or other important information

Bulb Shape	Base Type	Watts	Order Code	Description	Volts	Carton Qty <sup>2</sup>	MOL (in)	Lumens (Initial)	Color Temp. (Initial)	CRI	Wattage Replacement	Rated Life L70 (Hrs) <sup>1</sup>	Dimmable	Location Rating <sup>3</sup>	Additional Information
CA	E12	3.5	93142795	LED4DFCAC-C-2PK	120	12	4.6	300	2700K	80	40	15,000	Yes	Damp	All Glass, Clear, Bent Tip, 2 pack

## LED4DFCAC-C-2PK

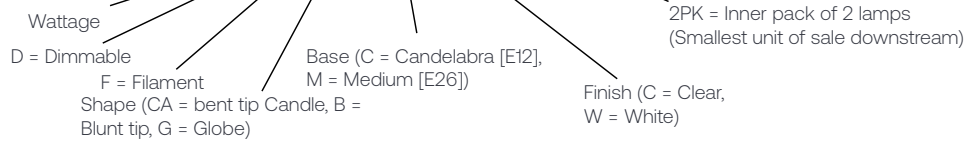

## Lamp Drawings (not drawn to scale)

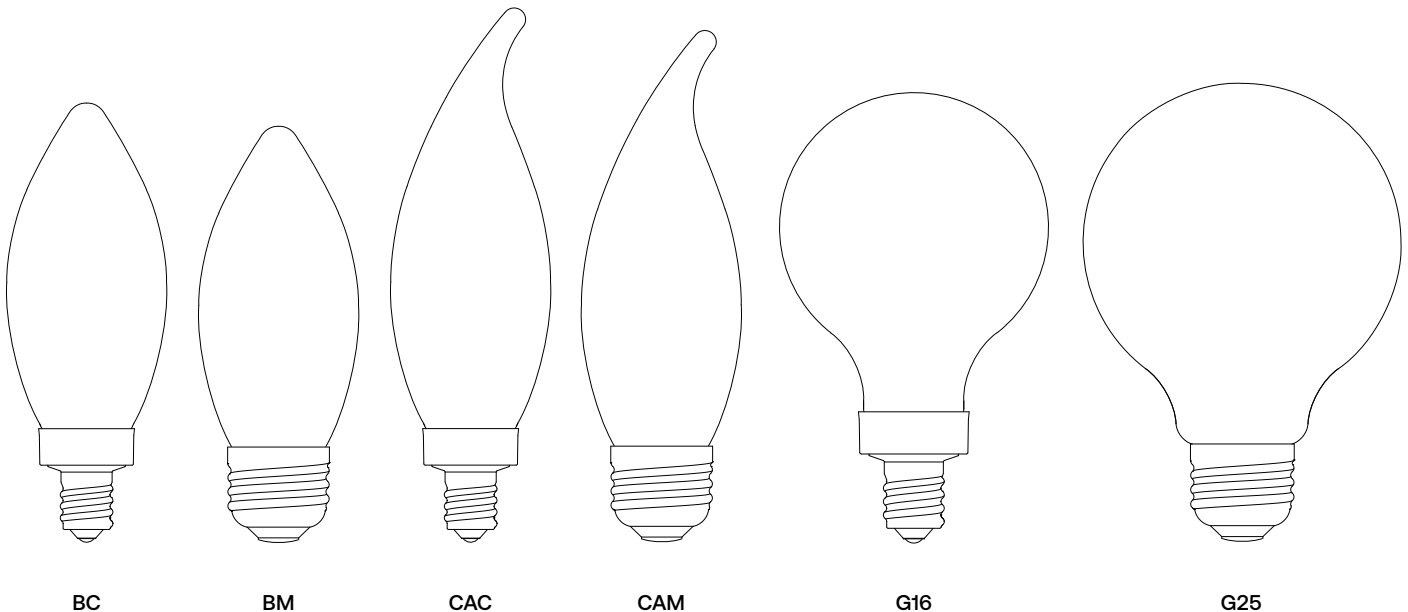

# LED Lamps - General Purpose

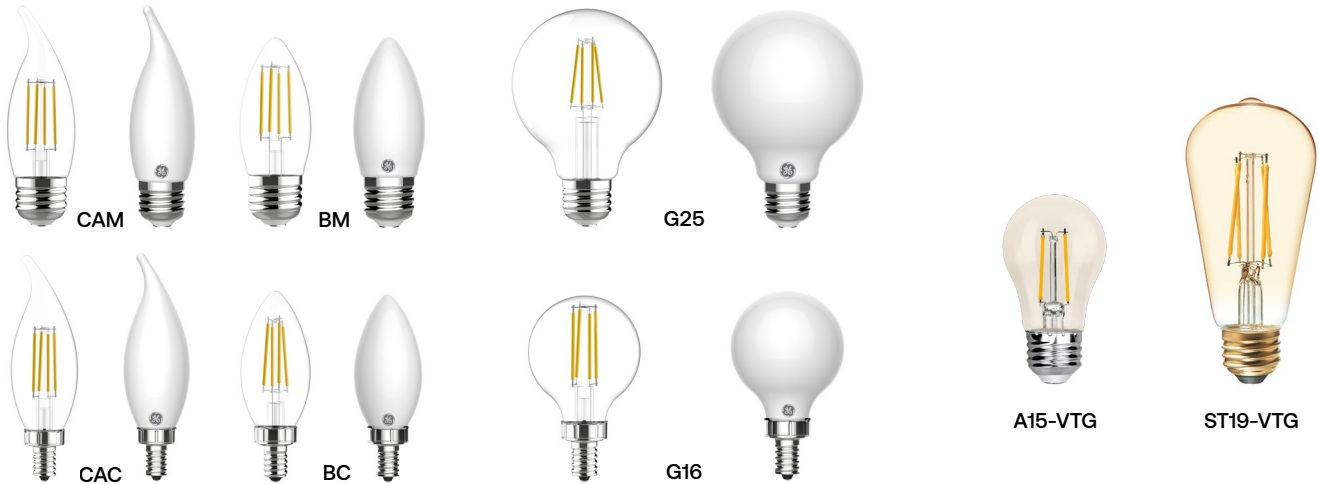

## Decorative Lamps

Bulb Shape	Base Type	Watts	Order Code	Description	Volts	Carton Qty <sup>2</sup>	MOL (in)	Lumens (Initial)	Color Temp. (Initial)	CRI	Wattage Replacement	Rated Life L70 (Hrs) <sup>1</sup>	Dimmable	Location Rating <sup>3</sup>	Additional Information
<b>Candies</b>															
<b>CA/B</b>	E26	2.5	93142804	LED3DFCAM-C-2PK	120	12	4.4	200	2700K	80	25	15,000	Yes	Damp	All Glass, Clear, Bent Tip, 2 pack
	E26	2.5	93142808	LED3DFCAM-W-2PK	120	12	4.4	200	2700K	80	25	15,000	Yes	Damp	All Glass, White, Bent Tip, 2 pack
	E26	3.5	93142811	LED4DFBM-C-2PK	120	12	3.8	300	2700K	80	40	15,000	Yes	Damp	All Glass, Clear, 2 pack
	E26	3.5	93142814	LED4DFBM-W-2PK	120	12	3.8	300	2700K	80	40	15,000	Yes	Damp	All Glass, White, 2 pack
	E26	3.5	93311960	LED4DFCAM-C/927	120	12	4.4	300	2700K	90	40	15,000	Yes	Damp	All Glass, Clear, Bent Tip, CEC Title 20
	E26	3.5	93142812	LED4DFCAM-C-2PK	120	12	4.4	300	2700K	80	40	15,000	Yes	Damp	All Glass, Clear, Bent Tip, 2 pack
	E26	3.5	93142815	LED4DFCAM-W-2PK	120	12	4.4	300	2700K	80	40	15,000	Yes	Damp	All Glass, White, Bent Tip, 2 pack
	E26	5	93142855	LED5DFBM-C-2PK	120	12	3.8	500	2700K	80	60	15,000	Yes	Damp	All Glass, Clear, 2 pack
	E26	5	93142856	LED5DFBM-W-2PK	120	12	3.8	500	2700K	80	60	15,000	Yes	Damp	All Glass, White, 2 pack
	E26	5	93142851	LED5DFCAM-C-2PK	120	12	4.4	500	2700K	80	60	15,000	Yes	Damp	All Glass, Clear, Bent Tip, 2 pack
	E26	5	93142852	LED5DFCAM-W-2PK	120	12	4.4	500	2700K	80	60	15,000	Yes	Damp	All Glass, White, Bent Tip, 2 pack
	E12	2.5	93142792	LED3DFCAC-C-2PK	120	12	4.6	200	2700K	80	25	15,000	Yes	Damp	All Glass, Clear, Bent Tip, 2 pack
	E12	2.5	93142793	LED3DFCAC-W-2PK	120	12	4.6	200	2700K	80	25	15,000	Yes	Damp	All Glass, White, Bent Tip, 2 pack
	E12	3.5	93142794	LED4DFBC-C-2PK	120	12	3.9	300	2700K	80	40	15,000	Yes	Damp	All Glass, Clear, 2 pack
	E12	3.5	93142796	LED4DFBC-W-2PK	120	12	3.9	300	2700K	80	40	15,000	Yes	Damp	All Glass, White, 2 pack
	E12	3.5	93312028	LED4DFCAC-C/927	120	12	4.6	300	2700K	90	40	15,000	Yes	Damp	All Glass, Clear, Bent Tip, CEC Title 20
	E12	3.5	93142795	LED4DFCAC-C-2PK	120	12	4.6	300	2700K	80	40	15,000	Yes	Damp	All Glass, Clear, Bent Tip, 2 pack
	E12	3.5	93142797	LED4DFCAC-W-2PK	120	12	4.6	300	2700K	80	40	15,000	Yes	Damp	All Glass, White, Bent Tip, 2 pack
E12	5	93142802	LED5DFBC-C-2PK	120	12	3.9	500	2700K	80	60	15,000	Yes	Damp	All Glass, Clear, 2 pack	
E12	5	93142803	LED5DFBC-W-2PK	120	12	3.9	500	2700K	80	60	15,000	Yes	Damp	All Glass, White, 2 pack	
E12	5	93142800	LED5DFCAC-C-2PK	120	12	4.6	500	2700K	80	60	15,000	Yes	Damp	All Glass, Clear, Bent Tip, 2 pack	
E12	5	93142801	LED5DFCAC-W-2PK	120	12	4.6	500	2700K	80	60	15,000	Yes	Damp	All Glass, White, Bent Tip, 2 pack	
<b>Globes</b>															
<b>G25</b>	E26	2.8	93142805	LED3DFG25-C-2PK	120	12	4.7	250	2700K	80	25	15,000	Yes	Damp	All Glass, Clear, 2 pack
	E26	2.8	93142807	LED3DFG25-W-2PK	120	12	4.7	250	2700K	80	25	15,000	Yes	Damp	All Glass, White, 2 pack
	E26	4	93311963	LED4DFG25-C/927	120	12	4.7	350	2700K	90	40	15,000	Yes	Damp	All Glass, Clear, CEC Title 20
	E26	4	93311966	LED4DFG25-W/927	120	12	4.7	350	2700K	90	40	15,000	Yes	Damp	All Glass, White, CEC Title 20
	E26	4	93142847	LED4DFG25-C-2PK	120	12	4.7	350	2700K	80	40	15,000	Yes	Damp	All Glass, Clear, 2 pack
	E26	4	93142846	LED4DFG25-W-2PK	120	12	4.7	350	2700K	80	40	15,000	Yes	Damp	All Glass, White, 2 pack
	E26	5	93142850	LED5DFG25-C-2PK	120	12	4.7	500	2700K	80	60	15,000	Yes	Damp	All Glass, Clear, 2 pack
	E26	5	93142849	LED5DFG25-W-2PK	120	12	4.7	500	2700K	80	60	15,000	Yes	Damp	All Glass, White, 2 pack
<b>G16.5</b>	E12	3.5	28280	LED3DFG16-GW-2T	120	12	3.0	250	2700K	80	25	15,000	Yes	Damp	All Glass, White, 2 pack <sup>^</sup>
	E12	4	93142798	LED4DFG16C-C-2PK	120	12	3.4	350	2700K	80	40	15,000	Yes	Damp	All Glass, Clear, 2 pack
	E12	4	93142799	LED4DFG16C-W-2PK	120	12	3.4	350	2700K	80	40	15,000	Yes	Damp	All Glass, White, 2 pack

## Vintage Style Decorative Lamps

Bulb Shape	Base Type	Watts	Order Code	Description	Volts	Carton Qty <sup>2</sup>	MOL (in)	Lumens (Initial)	Color Temp. (Initial)	CRI	Wattage Replacement	Rated Life L70 (Hrs) <sup>1</sup>	Dimmable	Location Rating <sup>3</sup>	Additional Information
<b>Vintage</b>															
A15	E26	3	93311928	LED3DFA15-C-VTG	120	12	3.5	150	2150K	90	25	15,000	Yes	Damp	All Glass, Clear Amber, CEC Title 20 Exempt
ST19	E26	5.5	93311890	LED5DFST19-C-VTG	120	12	5.3	400	2150K	90	40	15,000	Yes	Damp	All Glass, Clear Amber, CEC Title 20 Exempt

<sup>1</sup> The life rating is based on the hours of operation the lamp will provide before reaching 70% of its original lumen output (L70)

<sup>2</sup> Minimum order quantity = Carton Qty

<sup>3</sup> UL 1993 Environmental Requirements for LED LAMPS

Damp Location - Exterior or interior location that is normally or periodically subject to condensation of moisture in, on, or adjacent to electrical equipment, including partially protected locations

<sup>^</sup> GE Lighting, a Savant company, lamp, distributed Current Lighting Solutions, LLC.

# LED Lamps – Packaging Notes



## LED Lamps - Inner Pack Lamp Quantity

Packaging configurations vary across the wide range of LED Lamps offered by Current. LED Tubes are packaged in bulk, with no inner pack inside the outer carton. Many lamps, such as LED HID, are packaged in individual packs inside the outer carton. The table below details the materials that are packaged into saleable units of **more than one lamp**. These inner pack sizes are noted throughout the catalog in the "Additional Information" column, but the table below is provided as another reference.

Lamp Category	Order Code	Description	Inner Pack Lamp Qty	Outer Carton Lamp Qty
Plug-in	93300091	LED11G24d-V/8SC-4PK	4	24
Plug-in	93300090	LED11G24d-H/8SC-4PK	4	24
Plug-in	93300089	LED9G24q-V/8SC-4PK	4	24
Plug-in	93300088	LED11BG24-V/8SC/120-347-4PK	4	24
Plug-in	93300087	LED11BG24-H/8SC/120-347-4PK	4	24
Plug-in	93300068	LED8BG24-O/827-4PK	4	24
Plug-in	93300069	LED8BG24-O/830-4PK	4	24
Plug-in	93300080	LED8BG24-O/835-4PK	4	24
Plug-in	93300081	LED8BG24-O/840-4PK	4	24
Plug-in	93300082	LED10BG24-O/827-4PK	4	24
Plug-in	93300083	LED10BG24-O/830-4PK	4	24
Plug-in	93300084	LED10BG24-O/835-4PK	4	24
Plug-in	93300086	LED10BG24-O/840-4PK	4	24
PAR	93305603	LED6DP16W830/35-6PK	6	24
PAR	93153892	LED12DP30VOW830/25-4PK	4	16
PAR	93153891	LED12DP30LVOW830/25-4PK	4	16
PAR	93153880	LED15DP38VOW830/35-4PK	4	16
MR16	93305604	LED4D/GU10W830/35-6PK	6	24
MR16	93305605	LED5D/GU10W830/35-6PK	6	24
RS Can	93162554	LED8DRS4/9SC-4PK	4	16
RS Can	93162555	LED8DRS6/9SC-4PK	4	16
RS Can	93162556	LED12DRS6/9SC-4PK	4	16
Reflector	93305498	LED8DBR30/927-6PK	6	24
Reflector	93305499	LED8DBR30/930-6PK	6	24
Reflector	93305510	LED8DBR30/940-6PK	6	24
Reflector	93305512	LED8DBR30/950-6PK	6	24
A-line	93142809	LED4DFA15-C-2PK	2	12
A-line	93142810	LED4DFA15-W-2PK	2	12
A-line	37669	LED5DAGCSW-2P 120	2	12
A-line	93156446	LED6DA19/827/E-4PK	4	24
A-line	93156447	LED6DA19/830/E-4PK	4	24
A-line	93156448	LED6DA19/840/E-4PK	4	24
A-line	93156449	LED6DA19/850/E-4PK	4	24
A-line	93156450	LED10DA19/827/E-4PK	4	24
A-line	93156531	LED10DA19/830/E-4PK	4	24
A-line	93156532	LED10DA19/840/E-4PK	4	24
A-line	93156533	LED10DA19/850/E-4PK	4	24
A-line	93156534	LED12DA19/827/E-4PK	4	24
A-line	93156535	LED12DA19/830/E-4PK	4	24
A-line	93156536	LED12DA19/840/E-4PK	4	24
A-line	93156537	LED12DA19/850/E-4PK	4	24
A-line	93156538	LED15DA19/827-4PK	4	24
A-line	93156539	LED15DA19/830-4PK	4	24
A-line	93156540	LED15DA19/840-4PK	4	24
A-line	93156541	LED15DA19/850-4PK	4	24
A-line	93305532	LED6DA19/927/E-4PK	4	24
A-line	93305533	LED6DA19/950/E-4PK	4	24
A-line	93305534	LED10DA19/927/E-4PK	4	24
A-line	93305535	LED10DA19/950/E-4PK	4	24
A-line	93305536	LED13DA19/927-4PK	4	24
A-line	93305537	LED13DA19/950-4PK	4	24
A-line	93305538	LED15DA19/927-4PK	4	24
A-line	93305539	LED15DA19/950-4PK	4	24
A-line	93156542	LED10DA19/GU24/827/E-4PK	4	24
A-line	93156543	LED15DA19/GU24/827-4PK	4	24
A-line	93156602	LED13A19/30/100/827-4PK	4	24
A-line	93156603	LED17A21/50/150/827-4PK	4	24

Lamp Category	Order Code	Description	Inner Pack Lamp Qty	Outer Carton Lamp Qty
A-line	93142977	LED5A19/827-4PK	4	24
A-line	93142978	LED5A19/830-4PK	4	24
A-line	93142979	LED5A19/840-4PK	4	24
A-line	93142980	LED5A19/850-4PK	4	24
A-line	93142981	LED9A19/827-4PK	4	24
A-line	93142982	LED9A19/830-4PK	4	24
A-line	93142983	LED9A19/840-4PK	4	24
A-line	93142984	LED9A19/850-4PK	4	24
A-line	93142985	LED11A21/827-4PK	4	24
A-line	93142986	LED11A21/830-4PK	4	24
A-line	93142987	LED11A21/840-4PK	4	24
A-line	93142988	LED11A21/850-4PK	4	24
A-line	93142989	LED15A21/827-4PK	4	24
A-line	93142990	LED15A21/830-4PK	4	24
A-line	93142991	LED15A21/840-4PK	4	24
A-line	93142992	LED15A21/850-4PK	4	24
Bright Stik™	66256	LED5.5LS3/827	3	48
Bright Stik™	75177	LED5.5LS3/850	3	48
Bright Stik™	75184	LED9LS3/827	3	48
Bright Stik™	75588	LED9LS3/850	3	48
Bright Stik™	75590	LED12LS2/827	2	32
Bright Stik™	75591	LED12LS2/850	2	32
Bright Stik™	75593	LED15LS2/827	2	32
Bright Stik™	75644	LED15LS2/850	2	32
Decorative	93142804	LED3DFCAM-C-2PK	2	12
Decorative	93142808	LED3DFCAM-W-2PK	2	12
Decorative	93142811	LED4DFBM-C-2PK	2	12
Decorative	93142814	LED4DFBM-W-2PK	2	12
Decorative	93142812	LED4DFCAM-C-2PK	2	12
Decorative	93142815	LED4DFCAM-W-2PK	2	12
Decorative	93142855	LED5DFBM-C-2PK	2	12
Decorative	93142856	LED5DFBM-W-2PK	2	12
Decorative	93142851	LED5DFCAM-C-2PK	2	12
Decorative	93142852	LED5DFCAM-W-2PK	2	12
Decorative	93142792	LED3DFCAC-C-2PK	2	12
Decorative	93142793	LED3DFCAC-W-2PK	2	12
Decorative	93142794	LED4DFBC-C-2PK	2	12
Decorative	93142796	LED4DFBC-W-2PK	2	12
Decorative	93142795	LED4DFCAC-C-2PK	2	12
Decorative	93142797	LED4DFCAC-W-2PK	2	12
Decorative	93142802	LED5DFBC-C-2PK	2	12
Decorative	93142803	LED5DFBC-W-2PK	2	12
Decorative	93142800	LED5DFCAC-C-2PK	2	12
Decorative	93142801	LED5DFCAC-W-2PK	2	12
Decorative	93142805	LED3DFG25-C-2PK	2	12
Decorative	93142807	LED3DFG25-W-2PK	2	12
Decorative	93142847	LED4DFG25-C-2PK	2	12
Decorative	93142846	LED4DFG25-W-2PK	2	12
Decorative	93142850	LED5DFG25-C-2PK	2	12
Decorative	93142849	LED5DFG25-W-2PK	2	12
Decorative	28280	LED3DFG16-GW-2T	2	12
Decorative	93142798	LED4DFG16C-C-2PK	2	12
Decorative	93142799	LED4DFG16C-W-2PK	2	12



# TRADITIONAL LAMPS & BALLASTS

---

Current carries a full family of Traditional lamps that feature plug-and-play simplicity. Our engineering leadership over the years in Traditional lighting has resulted in products that provide the exceptional light quality that you know and love.



# Traditional Lamps



# Linear Fluorescent Lamps



**Linear** Fluorescent lighting, first introduced by GE in 1939, continues to offer low operating costs and long life.

## Lamp Drawings (not drawn to scale)

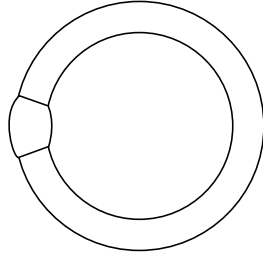

T9 Circline (1-1/8" diameter) 4-Pin Base (G10q)

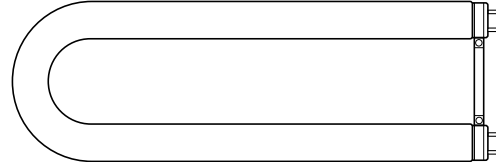

Mod-U-Line® T8/U6 (1" diameter) Medium Bi-Pin Base (G13)

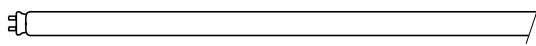

T5 (5/8" diameter) Miniature Bi-Pin Base (G5)

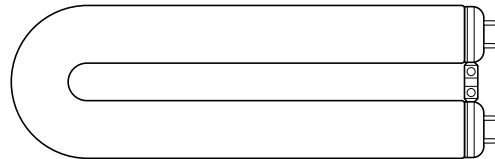

Mod-U-Line® T12/U3 (1 1/2" diameter) Medium Bi-Pin Base (G13)

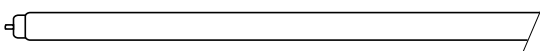

T6 (3/4" diameter) Single Pin Base (Fa8)

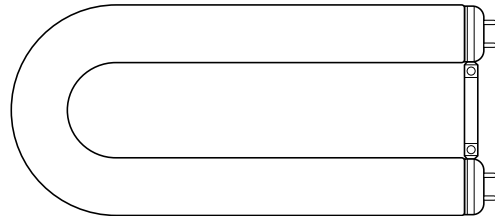

Mod-U-Line® T12/U6 (1-1/2" diameter) Medium Bi-Pin Base (G13)

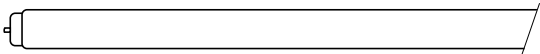

T8 (1" diameter) Single Pin Base (Fa8)

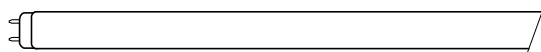

T8 (1" diameter) Medium Bi-Base (G13)

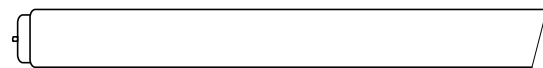

T12 (1-1/2" Diameter) Single Pin Base (Fa8)

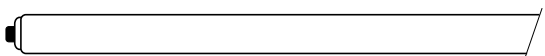

T8 (1" diameter) Recessed Double Contact Base (R17d)

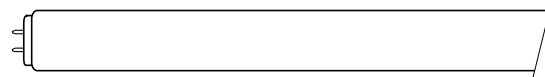

T12 (1-1/2" Diameter) Medium Bi-Pin Base (G13)

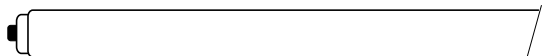

T10 (11/4" diameter) Recessed Double Contact Base (R17d)

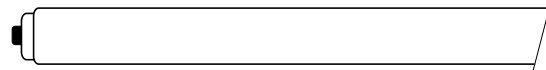

T12 (1-1/2" Diameter) Recessed Double Contact Base (R17d)

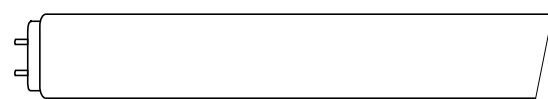

T17 (2-1/8" diameter) Mogul Bi-Pin (G20)

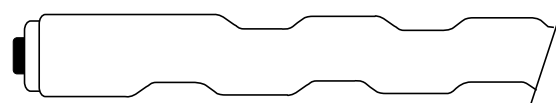

Power Groove® (2-1/8" diameter)  
Recessed Double Contact Base (R17d)

# Linear Fluorescent Lamps



## Base Identification (not drawn to scale)

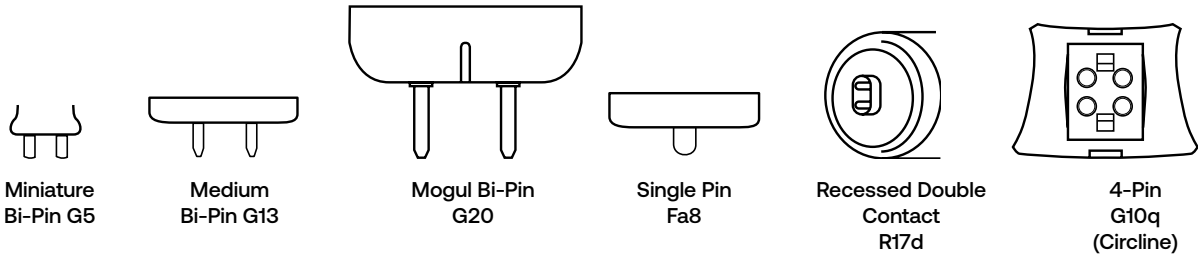

## Catalog Logic:

The following terms and descriptions can help you when checking fluorescent lamp specifications and when ordering products. Within each product line, lamps are divided into families and listed by bulb, base and then wattage.

Bulb Shape	Base Type	Watts	Nominal Length (in.)	Order Code	Description	Carton Qty	Rated Life (3hr/Start)	Rated Life (12hr/Start)	Initial Lumens	Mean Lumens	Color Temp.	CRI	Type B LED Replacement
T5	G5	14	21.6	31590	F14W/T5/830/ECO	40	30,000	36,000	1,350	1,240	3000K	85	93128494 LED9BDT5G2/830HE

**Bulb Shape:** followed by its size (the maximum diameter of the bulb expressed in eighths of an inch).

**Watts:** Energy used (as defined by FTC Lamp Label Rules). To estimate energy consumption (kWh), multiply watts x hours of use and divide by 1000.

**Base:** The type of base

**Nominal Length (in):** Lamp length including base and/or pins.

**Order Code:** Use the order code when ordering to ensure that you receive the exact product you require.

**Description:** Lamp Model Description

**Carton Quantity:** Number of lamps packed in a carton

**Rated Life (hours):** Life (as defined by FTC Lamp Label Rules) is rated life in hours.

**Initial Lumens:** Lamp light output after the initial 100 hours of operation.

**Means Lumens:** Lamp light output at 40% of rated lamp life or 8K hours for lamps exceeding 20K hours life.

**Color Temperature – Kelvins (K):** A measure of the visual "warmth" or "coolness" of the light from the lamp. The higher the value, the whiter or "cooler" the light appears.

**Color Rendering Index (CRI or R):** An indication of the ability of the lamp to render object colors in a normal natural way. The higher the number (0-100), the better the color appearance

**LED Replacement:** Current offers a wide range of LED replacement lamps. The LED lamp models are provided as general guidance. Often, there will be more than one LED lamp that may be used to replace a Traditional lamp. For Traditional lamps that operated off a ballast, the ballast bypass (UL Type B) LED option is given unless otherwise noted. The application should be considered when selecting an LED replacement lamp. Sometimes, Traditional lamps do not have a suitable LED replacement due to special application considerations, such as very high heat. Contact Current for additional guidance if the appropriate LED solution is unclear.

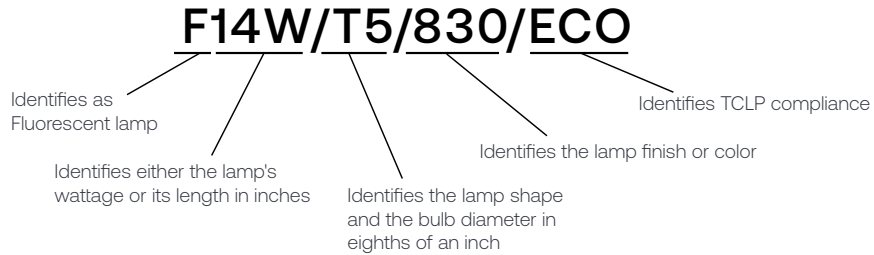

Lamp Contains Mercury. Manage in Accord with Disposal Laws. See [www.lamprecycle.org](http://www.lamprecycle.org) or 1-800-327-0097

# Linear Fluorescent Lamps



**\*\*Fluorescent Phase-Out Regulations\*\*:** Several US states have enacted legislation that prohibit/will prohibit the sale of Linear and Compact Fluorescent Lamps within their state. For more information including effective dates, please visit [www.LED.com/lamplegislation](http://www.LED.com/lamplegislation)

## T5 Starcoat Ecolux® Lamps

													Type B LED Replacement		
Bulb Shape	Base Type	Nominal Watts	Nominal Length (in.)	Order Code	Description	Carton Qty <sup>1</sup>	Rated Life (3hr/Start)	Rated Life (12hr/Start)	Initial Lumens	Mean Lumens	Color Temp.	CRI	Notes	Order Code	Description
<b>T5 High Efficiency</b>															
T5	G5	14	21.6	31590	F14W/T5/830/ECO	40	30,000	36,000	1,350	1,240	3000K	85		93128494	LED9BDT5G2/830HE
	G5	14	21.6	46671	F14W/T5/835/ECO	40	30,000	36,000	1,350	1,240	3500K	85		93128495	LED9BDT5G2/835HE
	G5	14	21.6	46673	F14W/T5/841/ECO	40	30,000	36,000	1,350	1,240	4100K	85		93128570	LED9BDT5G2/840HE
	G5	21	33.4	46677	F21W/T5/830/ECO	40	30,000	36,000	2,100	1,930	3000K	85		93128488	LED11BDT5G3830HE
	G5	21	33.4	46684	F21W/T5/835/ECO	40	30,000	36,000	2,100	1,930	3500K	85		93128490	LED11BDT5G3835HE
	G5	21	33.4	46687	F21W/T5/841/ECO	40	30,000	36,000	2,100	1,930	4100K	85		93128491	LED11BDT5G3840HE
	G5	28	45.2	46704	F28W/T5/830/ECO	40	30,000	36,000	2,900	2,660	3000K	85		93128354	LED14BDT5G4830HE
	G5	28	45.2	46705	F28W/T5/835/ECO	40	30,000	36,000	2,900	2,660	3500K	85		93128355	LED14BDT5G4835HE
	G5	28	45.2	46706	F28W/T5/841/ECO	40	30,000	36,000	2,900	2,660	4100K	85		93128486	LED14BDT5G4840HE
	<b>T5 High Output</b>														
T5	G5	24	21.6	46699	F24W/T5/830/ECO	40	30,000	36,000	2,000	1,840	3000K	85		93113793	LED11BDT5/G2/830
	G5	24	21.6	46700	F24W/T5/835/ECO	40	30,000	36,000	2,000	1,840	3500K	85		93114322	LED11BDT5/G2/835
	G5	24	21.6	46701	F24W/T5/841/ECO	40	30,000	36,000	2,000	1,840	4100K	85		93114323	LED11BDT5/G2/840
	G5	39	33.4	46744	F39W/T5/830/ECO	40	30,000	36,000	3,500	3,220	3000K	85		93114325	LED17BDT5/G3/830
	G5	39	33.4	46745	F39W/T5/835/ECO	40	30,000	36,000	3,500	3,220	3500K	85		93114626	LED17BDT5/G3/835
	G5	54	45.2	46759	F54W/T5/830/ECO	40	30,000	36,000	5,000	4,600	3000K	85		93100292	LED25BDT5/G4/830
	G5	54	45.2	46760	F54W/T5/835/ECO	40	30,000	36,000	5,000	4,600	3500K	85		93100293	LED25BDT5/G4/835
	G5	54	45.2	46761	F54W/T5/841/ECO	40	30,000	36,000	5,000	4,600	4100K	85		93100294	LED25BDT5/G4/840
	G5	54	45.2	46762	F54W/T5/850/ECO	40	30,000	36,000	4,800	4,410	5000K	85		93100295	LED25BDT5/G4/850
	G5	54	45.2	46763	F54W/T5/865/ECO	40	30,000	36,000	4,750	4,370	6500K	85		93100295	LED25BDT5/G4/850

## T5 Preheat Lamps

													Type B LED Replacement		
Bulb Shape	Base Type	Nominal Watts	Nominal Length (in.)	Order Code	Description	Carton Qty <sup>1</sup>	Rated Life (3hr/Start)	Initial Lumens	Mean Lumens	Color Temp.	CRI	Notes	Order Code	Description	
<b>12" and 21" Short T5</b>															
T5	G5	8	12.0	10059	F8T5/CW	24	5,000	400	320	4100K	60				
	G5	13	21.0	10086	F13T5/CW	24	5,000	850	705	4100K	60				

## T8 Starcoat® Lamps

													Type B LED Replacement		
Bulb Shape	Base Type	Nominal Watts	Nominal Length (in.)	Order Code	Description	Carton Qty <sup>1</sup>	Rated Life (3hr/Start)	Rated Life (12hr/Start)	Initial Lumens	Mean Lumens	Color Temp.	CRI	Notes	Order Code	Description
<b>2' T8 Ecolux®</b>															
T8	G13	17	24.0	45741	F17T8/SP30/ECO	24	30,000	36,000	1,325	1,260	3000K	78		39558	LED9BDT8/G2/830
	G13	17	24.0	45743	F17T8/SP35/ECO	24	30,000	36,000	1,325	1,260	3500K	78		39560	LED9BDT8/G2/835
	G13	17	24.0	45748	F17T8/SP41/ECO	24	30,000	36,000	1,325	1,260	4100K	78		39561	LED9BDT8/G2/840
<b>3' T8 Ecolux®</b>															
T8	G13	25	36.0	45754	F25T8/SP35/ECO	24	30,000	36,000	2,080	1,970	3500K	78		39547	LED12BDT8/G3/835
	G13	25	36.0	45756	F25T8/SP41/ECO	24	30,000	36,000	2,080	1,970	4100K	78		39554	LED12BDT8/G3/840
<b>4' T8 Ecolux®</b>															
T8	G13	32	48.0	68850	F32T8/SPX30/ECO2	36	30,000	36,000	2,925	2,770	3000K	85	Δ	39493	LED14BDT8/G4/830
	G13	32	48.0	68851	F32T8/SPX35/ECO2	36	30,000	36,000	2,925	2,770	3500K	85	Δ	39494	LED14BDT8/G4/835
	G13	32	48.0	68852	F32T8/SPX41/ECO2	36	30,000	36,000	2,925	2,770	4100K	85	Δ	39498	LED14BDT8/G4/840
	G13	32	48.0	68853	F32T8/SPX50/ECO2	36	30,000	36,000	2,900	2,755	5000K	82	Δ	39519	LED14BDT8/G4/850
	G13	32	48.0	66342	F32T8/SPX65/ECO2	36	30,000	36,000	2,900	2,755	6500K	78	Δ	39519	LED14BDT8/G4/850

<sup>1</sup> Minimum order quantity = Carton Qty

Δ Impacted by 4' fluorescent state legislation, SKU not for sale in Vermont after 1/1/2024 due to state legislation; for more information please visit [www.LED.com/lamplegislation](http://www.LED.com/lamplegislation)

# Linear Fluorescent Lamps



**\*\*Fluorescent Phase-Out Regulations\*\*:** Several US states have enacted legislation that prohibit/will prohibit the sale of Linear and Compact Fluorescent Lamps within their state. For more information including effective dates, please visit [www.LED.com/lamplegislation](http://www.LED.com/lamplegislation)

## Ultra Energy Saving T8 Lamps

Bulb Shape	Base Type	Watts	Nominal Length (in.)	Order Code	Description	Carton Qty <sup>1</sup>	Rated Life (3hr/Start)	Rated Life (12hr/Start)	Initial Lumens	Mean Lumens	Color Temp.	CRI	Notes	Type B LED Replacement	
														Order Code	Description
<b>4' T8 Ecolux<sup>®</sup> 25 Watt Lamp</b>															
T8	G13	25	48.0	72129	F32T8/25W/SPX35/ECO	36	50,000	55,000	2,500	2,350	3500K	85	Δ	93117213	LED11BDT8/G4/835
	G13	25	48.0	72130	F32T8/25W/SPX41/ECO	36	50,000	55,000	2,500	2,350	4100K	85	Δ	93117214	LED11BDT8/G4/840
	G13	25	48.0	72131	F32T8/25W/SPX50/ECO	36	50,000	55,000	2,500	2,350	5000K	80	Δ	93117215	LED11BDT8/G4/850
<b>4' T8 Ecolux<sup>®</sup> 28 Watt Lamp</b>															
T8	G13	28	48.0	72864	F28T8/XL/SPX35/ECO	36	45,000	50,000	2,675	2,515	3500K	85	Δ	93117213	LED11BDT8/G4/835
	G13	28	48.0	72866	F28T8/XL/SPX41/ECO	36	45,000	50,000	2,675	2,515	4100K	82	Δ	93117214	LED11BDT8/G4/840
	G13	28	48.0	72867	F28T8/XL/SPX50/ECO	36	45,000	50,000	2,675	2,515	5000K	80	Δ	93117215	LED11BDT8/G4/850
<b>4' T8 Ecolux<sup>®</sup> High Lumen</b>															
T8	G13	32	48.0	10326	F32T8/XL/SPX35/HL/ECO	36	40,000	45,000	3,100	2,915	3500K	85	Δ	39494	LED14BDT8/G4/835
	G13	32	48.0	10322	F32T8/XL/SPX41/HL/ECO	36	40,000	45,000	3,100	2,915	4100K	82	Δ	39498	LED14BDT8/G4/840
	G13	32	48.0	42556	F32T8/XL/SPX50/HL/ECO	36	40,000	45,000	3,000	2,820	5000K	80	Δ	39519	LED14BDT8/G4/850

## 8' T8 Lamps

Bulb Shape	Base Type	Watts	Nominal Length (in.)	Order Code	Description	Carton Qty <sup>1</sup>	Rated Life (3hr/Start)	Rated Life (12hr/Start)	Initial Lumens	Mean Lumens	Color Temp.	CRI	Notes	Type B LED Replacement	
														Order Code	Description
<b>8' T8 XL Extra-Life</b>															
T8	Fa8	59	96.0	68869	F96T8/XL/SPX35/2	24	24,000	30,000	5,950	5,650	3500K	85		93122171	LED34BDT8/G/8/835
	Fa8	59	96.0	68870	F96T8/XL/SPX41/2	24	24,000	30,000	5,400	4,860	4100K	85		93122172	LED34BDT8/G/8/840
	Fa8	59	96.0	68871	F96T8/XL/SPX50/2	24	24,000	30,000	5,950	5,650	5000K	82		93122174	LED34BDT8/G/8/850
<b>8' T8 XL Extra-Life Watt-Miser<sup>®</sup> Plus Energy Saving Lamps</b>															
T8	Fa8	54	96.0	15123	F96T8/XLSPX41WMP	24	24,000	30,000	5,400	5,000	4100K	84		93122172	LED34BDT8/G/8/840

## 8' T8 High Output Lamps

Bulb Shape	Base Type	Watts	Nominal Length (in.)	Order Code	Description	Carton Qty <sup>1</sup>	Rated Life (3hr/Start)	Initial Lumens	Mean Lumens	Color Temp.	CRI	Notes	Type B LED Replacement		
													Order Code	Description	
<b>8' T8 High Output – Recessed Double Contact</b>															
T8	R17D	86	96.0	12533	F96T8/SPX35/HO	24	18,000	8,200	7,800	3500K	85		93132591	LED43BDT8/G/8/835	
	R17D	86	96.0	12534	F96T8/SPX41/HO	24	18,000	8,200	7,800	4100K	85		93132592	LED43BDT8/G/8/840	
	R17D	86	96.0	12535	F96T8/SPX50/HO	24	18,000	8,200	7,800	5000K	82		93132593	LED43BDT8/G/8/850	

## T8 Mod-U-Line<sup>®</sup> Lamps

Bulb Shape	Base Type	Watts	Nominal Length (in.)	Order Code	Description	Carton Qty <sup>1</sup>	Rated Life (3hr/Start)	Initial Lumens	Mean Lumens	Color Temp.	CRI	Notes	Type B LED Replacement		
													Order Code	Description	
<b>T8 1-5/8" Spacing Ecolux<sup>®</sup></b>															
T8	G13	31	22.5	72118	F31T8/SPX35/U/ECO	15	24,000	2,775	2,440	3500K	82		93107352	LED13BDT8/U/835	
	G13	31	22.5	72119	F31T8/SPX41/U/ECO	15	24,000	2,775	2,440	4100K	82		93107388	LED13BDT8/U/840	
<b>T8 6" Spacing Ecolux<sup>®</sup></b>															
T8	G13	32	22.5	28145	F32T8/SP30/U6/ECO	12	20,000	2,700	2,375	3000K	78		93133049	LED13BDT8/U6/830	
	G13	32	22.5	28149	F32T8/SP35/U6/ECO	12	20,000	2,700	2,375	3500K	78		93133050	LED13BDT8/U6/835	
	G13	32	22.5	28152	F32T8/SP41/U6/ECO	12	20,000	2,700	2,375	4100K	78		93133051	LED13BDT8/U6/840	
	G13	32	22.5	72112	F32T8/SPX35/U6/ECO	12	20,000	2,800	2,465	3500K	82		93133050	LED13BDT8/U6/835	
	G13	32	22.5	72113	F32T8/SPX41/U6/ECO	12	20,000	2,800	2,465	4100K	82		93133051	LED13BDT8/U6/840	

## Special Application Lamps

Bulb Shape	Base Type	Watts	Nominal Length (in.)	Order Code	Description	Carton Qty <sup>1</sup>	Rated Life (3hr/Start)	Rated Life (12hr/Start)	Initial Lumens	Mean Lumens	Color Temp.	CRI	Additional Information	Type B LED Replacement	
														Order Code	Description
<b>covRguard<sup>®</sup> Shatter Resistant</b>															
<i>(T5 High Efficiency)</i>															
T5	G5	28	45.2	81547	F28W/T5/835/ECO/CVG	40	30,000	36,000	2,813	2,672	3500K	85	Blocks UV		
<i>(T5 High Output)</i>															
T5	G5	54	45.2	48458	F54T5/841/HO/ECO/CVG	40	30,000	36,000	4,850	4,560	4100K	85		93155904	LED25BDT5/G4/840/CVG
	G5	54	45.2	80311	F54T5/850/HO/ECO/CVG	40	30,000	36,000	4,650	4,370	5000K	85		93155905	LED25BDT5/G4/850/CVG
<b>T8 Ecolux<sup>®</sup> w/ Starcoat<sup>®</sup></b>															
<i>(4' T8 (48") Ecolux<sup>®</sup> w/Starcoat<sup>®</sup>)</i>															
T8	G13	32	48.0	41126	F32T8SPX35ECO/CVG	36	30,000	36,000	2,860	2,715	3500K	85	Blocks UV, Δ	93154588	LED16BDT8/G4/835XL/CVG
	G13	32	48.0	41127	F32T8SPX41ECO/CVG	36	30,000	36,000	2,860	2,715	4100K	85	Blocks UV, Δ	93154589	LED16BDT8/G4/840XL/CVG
	G13	32	48.0	15971	F32T8SPX50ECO/CVG	36	30,000	36,000	2,715	2,580	5000K	82	Blocks UV, Δ	93154586	LED16BDT8/G4/850XL/CVG

<sup>1</sup> Minimum order quantity = Carton Qty

Δ Impacted by 4' fluorescent state legislation, SKU not for sale in Vermont after 1/1/2024 due to state legislation; for more information please visit [www.LED.com/lamplegislation](http://www.LED.com/lamplegislation)

# Linear Fluorescent Lamps



**\*\*Fluorescent Phase-Out Regulations\*\*:** Several US states have enacted legislation that prohibit/will prohibit the sale of Linear and Compact Fluorescent Lamps within their state. For more information including effective dates, please visit [www.LED.com/lamplegislation](http://www.LED.com/lamplegislation)

## T12 Lamps

													Type B LED Replacement	
Bulb Shape	Base Type	Watts	Nominal Length (in.)	Order Code	Description	Carton Qty <sup>1</sup>	Rated Life (3hr/Start)	Initial Lumens	Mean Lumens	Color Temp.	CRI	Notes	Order Code	Description
<b>2' T12 - Preheat (TCLP Compliant)</b>														
T12	G13	20	24.0	80045	F20T12/CW/ECO	24	9,000	1,200	1,150	4100K	60		39561	LED9BDT8/G2/840
	G13	20	24.0	80047	F20T12/D/ECO	24	9,000	1,025	945	6500K	75		39563	LED9BDT8/G2/850
<b>4' T12 - Rapid Start (TCLP Compliant)</b>														
<b>(34W Watt-Miser<sup>®</sup> Ecolux<sup>®</sup>)</b>														
T12	G13	34	48.0	66474	F34CX41/WM/ECO	30	20,000	2,500	2,200	4100K	87	Δ	93117214	LED11BDT8/G4/840
<b>(40W Ecolux<sup>®</sup>)</b>														
T12	G13	40	48.0	80096	F40C50/ECO	30	20,000	2,250	1,870	5000K	90	Δ	93117215	LED11BDT8/G4/850
	G13	40	48.0	80097	F40DX/ECO	30	20,000	2,050	1,740	6500K	90	Δ	93117215	LED11BDT8/G4/850
<b>8' T12 Instant Start</b>														
<b>(8' Instant Start Standard)</b>														
T12	Fa8	75	96.0	14652	F96T12/DX	15	12,000	4,300	3,870	6500K	90		93122174	LED34BDT8/G/8/850
<b>(8' Instant Start Watt-Miser<sup>®</sup> XL Extra-life)</b>														
T12	Fa8	60	96.0	68052	F96T12/CW/C/WM	15	12,000	3,600	2,900	4100K	90		93122172	LED34BDT8/G/8/840
	Fa8	60	96.0	66858	F96T12XL/HL41/WM	15	12,000	5,900	5,480	4100K	80		93122172	LED34BDT8/G/8/840
<b>T12 High Output (800mA) Rapid Start Recessed Double Contact</b>														
<b>(4' High Output)</b>														
T12	R17D	60	48.0	10773	F48T12/CW/HO	24	12,000	3,825	3,320	4100K	60	Δ		
	R17D	60	48.0	10778	F48T12/D/HO	24	12,000	3,400	2,960	6500K	75	Δ		
<b>(5' High Output)</b>														
T12	R17D	75	60.0	23075	F60T12/CW/HO 15PK	15	12,000	5,150	4,480	4100K	60			
	R17D	75	60.0	23077	F60T12/D/HO 15PK	15	12,000	4,400	3,830	6500K	75			
<b>(6' High Output)</b>														
T12	R17D	85	72.0	13697	F72T12/CW/HO 15PK	15	12,000	6,350	5,520	4100K	60			
	R17D	85	72.0	13699	F72T12/D/HO 15PK	15	12,000	5,350	4,650	6500K	75			
<b>(7' High Output)</b>														
T12	R17D	100	84.0	13766	F84T12/CW/HO 15PK	15	12,000	7,700	6,700	4100K	60			
	R17D	100	84.0	13767	F84T12/D/HO 15PK	15	12,000	6,500	5,660	6500K	75			
<b>(8' High Output)</b>														
T12	R17D	95	96.0	66862	F96T12/HL41/HO/WM	15	12,000	8,850	7,920	4100K	77		93132592	LED43BDT8/G8/840

## Cold Temperature Lamps

													Type B LED Replacement		
Bulb Shape	Base Type	Watts	Nominal Length (in.)	Order Code	Description	Carton Qty <sup>1</sup>	Rated Life (3hr/Start)	Rated Life (12hr/Start)	Initial Lumens	Mean Lumens	Color Temp.	CRI	Notes	Order Code	Description
<b>High Output (800mA) Recessed Double Contact</b>															
T12	R17D	110	96.0	11918	F96T12/CW/HO/CT	15	12,000		8,900	7,740	4100K	60		93132592	LED43BDT8/G8/840
	R17D	110	96.0	11919	F96T12/D/HO/CT	15	12,000		7,600	6,610	6500K	75		93132593	LED43BDT8/G8/850

## T9 Circline<sup>®</sup> Lamps

													Type B LED Replacement	
Bulb Shape	Base Type	Watts	Nominal Length (in.)	Order Code	Description	Carton Qty <sup>1</sup>	Rated Life (3hr/Start)	Initial Lumens	Mean Lumens	Color Temp.	CRI	Notes	Order Code	Description
<b>T9 Circline<sup>®</sup> Lamps</b>														
T9	G10q	22	8.25	33774	FC8T9/CW	12	12,000	1,100	825	4100K	60			
	G10q	32	12.0	33890	FC12T9/CW	12	12,000	1,950	1,460	4100K	60			

<sup>1</sup> Minimum order quantity = Carton Qty

Δ Impacted by 4' fluorescent state legislation, SKU not for sale in Vermont after 1/1/2024 due to state legislation; for more information please visit [www.LED.com/lamplegislation](http://www.LED.com/lamplegislation)



## Regulation Readiness: Fluorescent Phase-Out

In an effort to regulate consumer products that contain mercury, state governments within the USA have passed legislation that will prohibit the sale and distribution of Linear and Compact Fluorescent lamps. The effective date of each state regulation is shown in the table below. This table will continue to evolve as new legislation is passed.

### Regulation Effective Date by Product Category

State	Product Category				
	4-Foot Linear Fluorescent	All Linear Fluorescent	Screw or Bayonet Based Compact Fluorescent	Pin Based Compact Fluorescent	Mercury Vapor High Intensity Discharge
Vermont	1/1/2024				
California		1/1/2025	1/1/2024	1/1/2025	
Colorado		1/1/2025	1/1/2024	1/1/2025	
Oregon		1/1/2025	1/1/2024	1/1/2025	
Rhode Island		1/1/2025	1/1/2024	1/1/2025	
Hawaii		1/1/2026	1/1/2025	1/1/2026	
Minnesota		1/1/2026	1/1/2025	1/1/2026	1/1/2025
Maine		1/1/2026	1/1/2026	1/1/2026	
Illinois		1/1/2027	1/1/2026	1/1/2027	
Washington State		1/1/2029	1/1/2029	1/1/2029	

### Mercury in Fluorescent Lighting

Fluorescent technology was developed by General Electric in 1934. While the amount of mercury in each fluorescent lamp has significantly decreased over the past 90 years, a small amount is still required to produce light in all Discharge lamps. When electricity is applied to a fluorescent tube, mercury ions emit energy in the form of ultraviolet (UV) light. UV light is then converted into visible light by interacting with the phosphor coating on the inside of the glass tube. Mercury has electrical characteristics that cannot be matched by other materials and remains a key component of fluorescent lighting.

### Transitioning to LED Lighting

LED (Light Emitting Diode) lamps do not contain mercury, and Current offers a variety of LED lamp options to replace Linear & Compact Fluorescent lamps. The different Types of LED lamps are explained in the following pages. Suggested LED replacements are noted for fluorescent lamps in the tables in this document. These are basic recommendations, but suitability should be evaluated for each specific application where fluorescent lamps were used. For more information about the transition from fluorescent to LED, contact your Current sales representative.

**To learn more about Fluorescent Regulations and LED replacements, please visit [www.LED.com/lamplaw](http://www.LED.com/lamplaw)**

# High Intensity Discharge Lamps



**High Intensity** Discharge lighting provides energy efficiency in a compact size for many commercial and industrial applications.

## Reference Guide | Bulb Identification

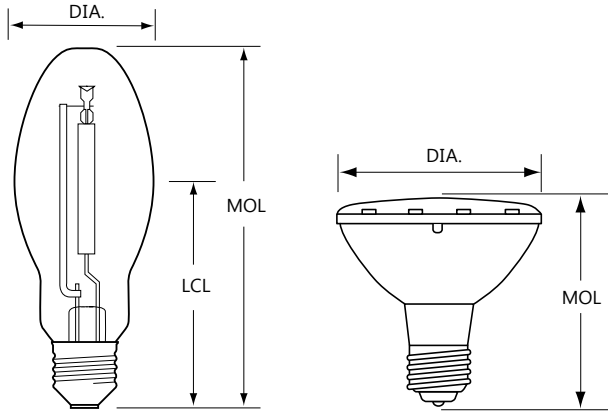

**DIA:** Diameter of bulb at widest point.  
**MOL:** Maximum Overall Length including base or pins.  
**LCL:** Distance between the center of the arc tube and the Light Center Length reference plane.  
**Note:** Lamp drawings are not drawn to scale. Be sure to check size and dimension information when identifying each lamp.

To convert inches to millimeters, multiply the dimension (in inches) by 25.4 (i.e. 1.5" x 25.4 = 38.1 mm).

## Filament Identification

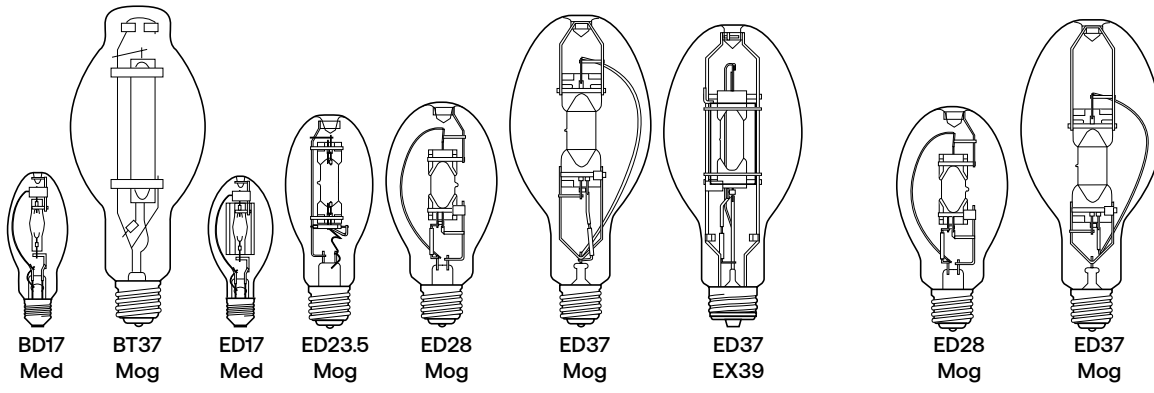

## Base Identification (not drawn to scale)

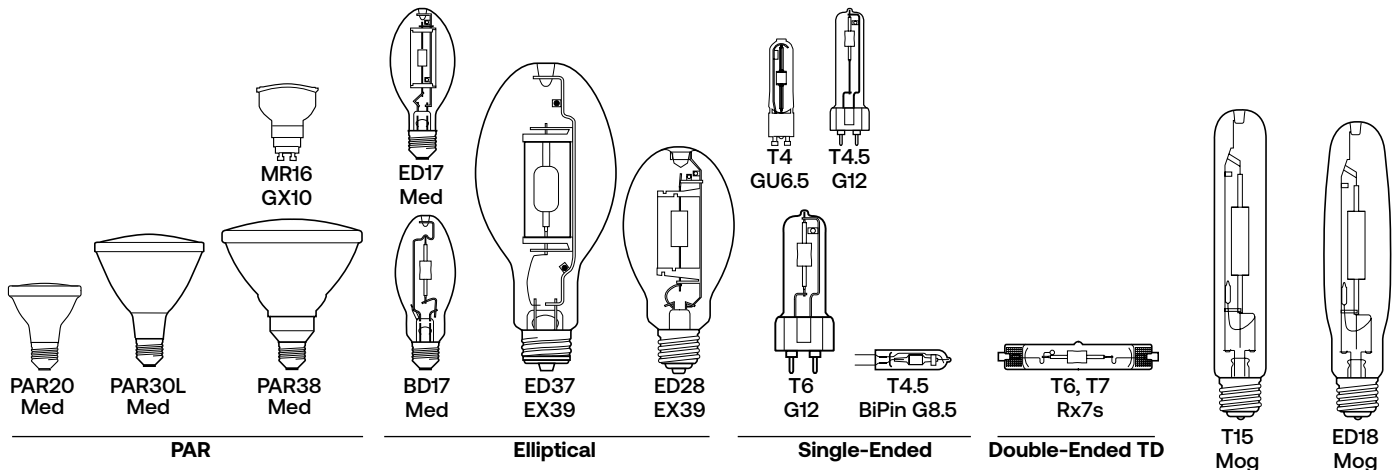

High Intensity Discharge Lamps

# High Intensity Discharge Lamps



## Lamp Drawings (not drawn to scale)

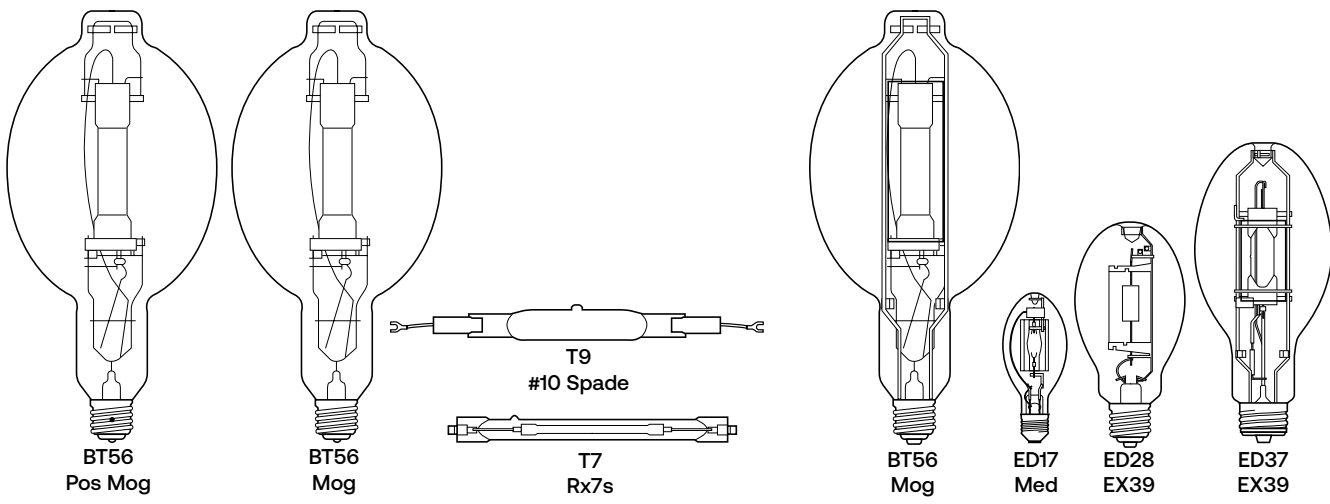
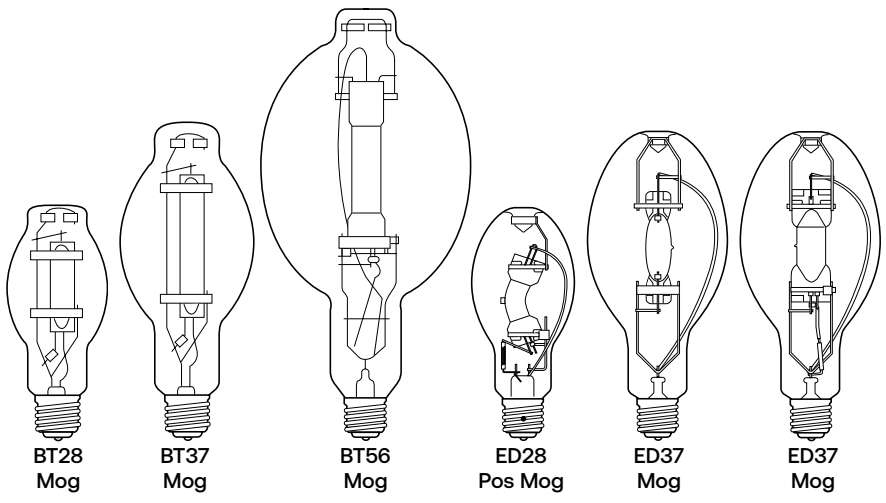
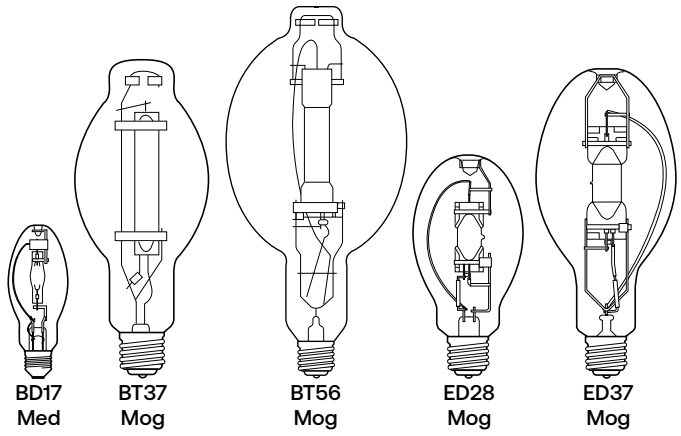

# High Intensity Discharge Lamps



## Lamp Drawings (Conti.) (not drawn to scale)

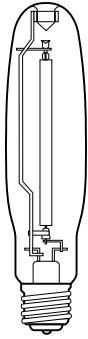

BD18  
Mog

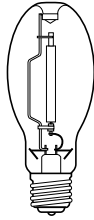

ED23.5  
Mog

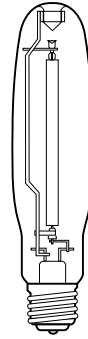

ED18  
Mog

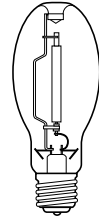

ED23.5  
Mog

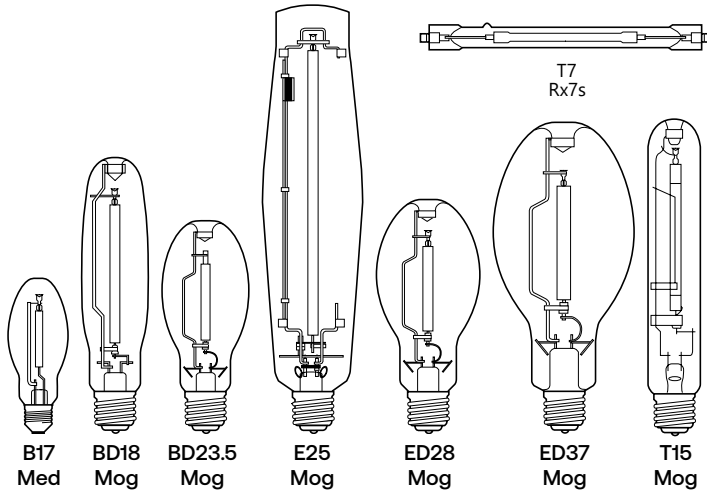

B17  
Med

BD18  
Mog

BD23.5  
Mog

E25  
Mog

ED28  
Mog

ED37  
Mog

T15  
Mog

T7  
Rx7s

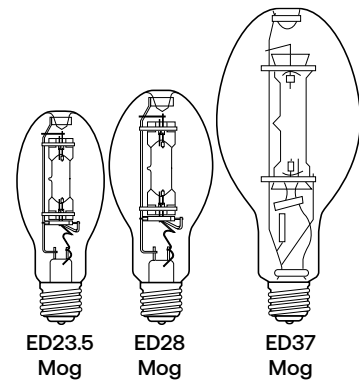

ED23.5  
Mog

ED28  
Mog

ED37  
Mog



# High Intensity Discharge Lamps

## Base Identification (not drawn to scale)



## Catalog Logic:

### Bulb Shape:

followed by its size (the maximum diameter of the bulb expressed in eighths of an inch).

**LET (Lamp Enclosure Type):**  
Describes fixture requirements for this lamp

**Base:**  
The type of base

**OP (Operating Position)**

### Watts:

Energy used (as defined by FTC Lamp Label Rules). To estimate energy consumption (kWh), multiply watts x hours of use and divide by 1000.

**LCL (in):**  
Distance between the center of the filament and the Light Center Length reference plane, in inches.

**MOL (in):**  
Maximum Overall Length in inches

**Order Code:**  
Use the order code when ordering to ensure that you receive the exact product you require.

### Description:

Lamp Model Description

### Color Temperature – Kelvins (K):

A measure of the visual "warmth" or "coolness" of the light from the lamp. The higher the value, the whiter or "cooler" the light appears.

### Means Lumens:

Lamp light output at 40% of rated lamp life or 8K hours for lamps exceeding 20K hours life.

### Rated Life (hours):

Life (as defined by FTC Lamp Label Rules) is rated life in hours.

### CBCP (Center beam Candlepower):

For reflector-type lamps, Center Beam Candlepower is the intensity (candelas) at the center of maximum intensity of the beam. Used only for ConstantColor® CMH® Metal Halide Lamps

**Carton Quantity:**  
Number of lamps packed in a carton

**ANSI Ballast Type:**  
Ballast type used to operate lamp

**Initial Lumens:**  
Lamp light output after the initial 100 hours of operation.

### Warning Notice:

Warning and Caution notices for High Intensity Discharge lamps. See pages 76 – 81

### LED Replacement:

Current offers a wide range of LED replacement lamps. The LED lamp models are provided as general guidance. Often, there will be more than one LED Lamp that may be used to replace a Traditional lamp. For Traditional lamps that operated off a ballast, the ballast bypass (UL Type B) LED option is given unless otherwise noted. The application should be considered when selecting an LED replacement lamp. Sometimes, Traditional lamps do not have a suitable LED replacement due to special application considerations, such as very high heat. Contact Current for additional guidance if the appropriate LED solution is unclear.

Bulb Shape	Base Type	LET	OP	Watts	MOL (in)	LCL (in)	Order Code	Description	ANSI Ballast Type	Car- ton Qty	Rated Life (hrs*)	Initial Lumens	Mean Lumens	Color Temp.	CRI	Warning Notice	Order Code	Description
CMH®	MR16/MR17																	
GX10	O	U		20	2.28		85101	CMH20MR16/830/SP	C156/M156	12	9,000	1,000		3000K	81	5		

## CMH20MR16/830/SP

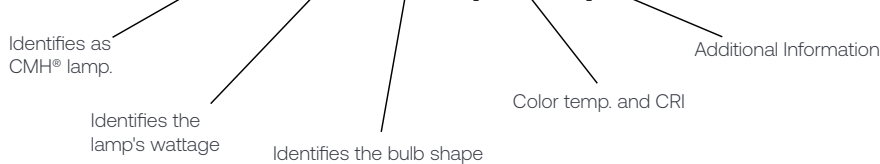

Lamp Contains Mercury. Manage in Accord with Disposal Laws. See [www.lamprecycle.org](http://www.lamprecycle.org) or 1-800-327-0097

# High Intensity Discharge Lamps



## Multi-Vapor® Metal Halide Lamps



																Type B LED Replacement		
Bulb Shape	Base Type	LET	OP	Watts	MOL (In)	LCL (In)	Order Code	Description	ANSI Ballast Type	Car-ton Qty <sup>1</sup>	Rated Life (hrs*)	Initial Lumens	Mean Lumens	Color Temp.	CRI	Warning Notice	Order Code	Description
<b>50 Watts - Enclosed Rated</b>																		
BD17	E26	E	U	50	5.43	3.43	10361	MXR50/U/MED	M110	6	10,000	3,200	2,100	3700K	60	1, 3	27729	LED21ED17/740
<b>70 Watts - Enclosed Rated</b>																		
BD17	E26	E	U	70	5.43	3.43	22158	MXR70/U/MED	M98	6	12,000	5,500	3,500	3500K	55	1, 3	27729	LED21ED17/740
BD17	E26	E	U	70	5.43	3.43	12590	MVR70/U/MED	M98	6	12000	5,500	3,000	4000K	65	1, 3	27729	LED21ED17/740
<b>70 Watts - Open Rated</b>																		
ED17	E26	O	U	70	5.43	3.43	12377	MXR70/U/MED/O	M98	6	15,000	5,500	3,500	3200K	70	3, 4	93303384	LED/LC/ED17/7SC
<b>100 Watts - Enclosed Rated</b>																		
BD17	E26	E	U	100	5.43	3.43	18680	MXR100/U/MED	M90	6	15,000	9,000	6,200	3200K	65	1, 3	93112114	LED35ED17/730
BD17	E26	E	U	100	5.43	3.43	12652	MVR100/U/MED	M90	6	15,000	9,500	5,800	4000K	70	1, 3	27602	LED35ED17/740
<b>100 Watts - Open Rated</b>																		
ED17	E26	O	U	100	5.43	3.43	12381	MXR100/U/MED/O	M90	6	15,000	9,000	6,200	3200K	70	3, 4	93112114	LED35ED17/730
<b>150 Watts - Enclosed Rated</b>																		
BD17	E26	E	U	150	5.43	3.43	12598	MVR150/U/MED	M102	6	15,000	14,000	10,500	4300K	65	1, 3	93303384	LED/LC/ED17/7SC
<b>150 Watts - Open Rated</b>																		
ED17	E26	O	U	150	5.43	3.43	45683	MXR150/U/MED/O	M102	6	15,000	12,500	8,600	3500K	70	3, 4	93303384	LED/LC/ED17/7SC
<b>175 Watts - Enclosed Rated</b>																		
BD17	E26	E	U	175	5.75	3.43	18902	MVR175/U/MED	M57	6	6,000H/ 10,000V	11,700H/ 14,000V	7,400H/ 8,800V	4000K	60	1, 2	93148082	LED45ED17/740
ED28	E39	E	U	175	8.25	5.00	47760	MVR175/U	M57	12	6,000H/ 10,000V	11,700H/ 13,600V	7,900H/ 8,800V	4000K	55	1, 2	22679	LED50ED23.5/740
ED28	E39	E	U	175	8.25	5.00	47761	MVR175/C/U	M57	12	6,000H/ 10,000V	11,900H/ 12,900V	7,900H/ 8,400V	3900K	55	1, 2	22679	LED50ED23.5/740
<b>250 Watts - Enclosed Rated</b>																		
ED28	E39	E	U	250	8.25	5.00	42729	MVR250/U	M58	12	6,000H/ 10,000V	19,100H/ 20,800V	12,400H/ 13,500V	4200K	60	1, 2	22635	LED80ED23.5/740
<b>250 Watts - Enclosed Rated, PulseArc</b>																		
ED28	E39	E	U	250	8.25	5.00	78665	MVR250/U/PA	M138/M153	12	12,000H/ 15,000V	18,600H/ 22,400V	12,000H/ 14,000V	3900K	60	1, 2	22635	LED80ED23.5/740
<b>320 Watts - Enclosed Rated, PulseArc</b>																		
ED28	E39	E	VBU	320	8.25	5.00	27501	MVR320/VBU/HO/PA	M132/M154	12	20,000	31,000	18,000	4000K	60	1, 2	22622	LED115ED28/740
<b>320 Watts - Open Rated</b>																		
ED37	EX39	O	VBU	320	11.50	7.00	46275	MPR320/VBU/XHOPA	M132/M154	6	20,000	32,000	22,500	4000K	65	3, 4	22622	LED115ED28/740
ED28	EX39	O	VBU	320	8.25	5.00	19609	MPR320/C/PA/ED28	M132/M154	12	20,000	30,600	22,500	3700K	70	3, 4	22622	LED115ED28/740
<b>400 Watts - Enclosed Rated</b>																		
ED28	E39	E	U	400	8.25	5.00	18904	MVR400/U/ED28	M59	12	15,000H/ 20,000V	33,100H/ 38,000V	22,100H/ 23,500V	4000K	60	1, 2	22611	LED150ED28/740
<b>400 Watts - Enclosed Rated, PulseArc</b>																		
ED37	E39	E	U	400	11.50	7.00	78666	MVR400/U/PA	M135/M155	6	15,000H/ 20,000V	31,200H/ 39,400V	18,000H/ 22,000V	4000K	60	1, 2	22611	LED150ED28/740
ED28	E39	E	VBU	400	8.25	5.00	46271	MVR400/VBUED28PA	M135/M155	12	20,000	44,000	28,500	4000K	65	1, 3	22611	LED150ED28/740
ED28	E39	E	HOR	400	8.25	5.00	72885	MVR400/HOR/ED28/PA	M135/M155	12	20,000	38,000	21,400	4100K	65	1, 3	22611	LED150ED28/740
<b>400 Watts - Open Rated</b>																		
ED37	EX39	O	VBU	400	11.50	7.00	46273	MPR400/VBU/XHOPA	M135/M155	6	20,000	42,000	29,500	4000K	65	3, 4	22611	LED150ED28/740
ED37	EX39	O	VBU	400	11.50	7.00	18708	MPR400/VBU/HO/O	M59	6	20,000	40,000	36,000	3400K	65	3, 4	93311586	LED/LC/ED37/740
<b>1000 Watts - Enclosed Rated</b>																		
BT37	E39	E	U	1000	11.50	7.00	18205	MVR1000/U/BT37	M47	6	9,000H/ 12,000V	105,000H/ 1150,00V	82,000H/ 90,000V	3700K	65	1, 2	93311586	LED/LC/ED37/740
<b>1000 Watts - Open Rated</b>																		
BT56	EX39	O	VBU	1000	15.37	9.50	41433	MPR1000/VBU/HO/O	M47	6	12,000	110,000	88,500	3500K	65	3, 4	93096445	LED450BT56/740
<b>1500 Watts - Enclosed Rated</b>																		
BT56	E39	E	U	1500	15.37	9.50	47326	MVR1500/U/SPORTS	M48	6	3,000	1620,00H/ 170,000V	137,000H/ 153,000V	4000K	65	1, 2	93303389	LED470BT56/740

<sup>1</sup> Minimum order quantity = Carton Qty

# High Intensity Discharge Lamps



## Constant Color CMH® Metal Halide Lamps



Bulb Shape	Base Type	LET	OP	Watts	MOL (In)	LCL (In)	Order Code	Description	ANSI Ballast Type	Car-ton Qty <sup>1</sup>	CBCP	Rated Life (hrs*)	Initial Lumens	Mean Lumens	Color Temp.	CRI	Warning Notice	LED Replacement	
																		Order Code	Description
<b>CMH® MR16/MR17</b>																			
GX10	O	U	20	2.28			85101	CMH20MR16/830/SP	C156/M156	12	9,000	12,000	1,000		3000K	81	5		
GX10	O	U	20	2.28			85110	CMH20MR16/830/FL	C156/M156	12	2,900	12,000	1,000		3000K	81	5		
GX10	O	U	39	2.28			71489	CMH39MR16/930/FL	C130/M130	12	5,500	10,000	2,200		3000K	90	5		
<b>CMH® PAR</b>																			
PAR30L	E26	O	U	39	4.75		42067	CMH39PAR30L/FL25	C130/M130	6	11,000	10,000	2,400		3000K	81	5	75091	LED18P30LW83025
<b>CMH® Single-Ended G12</b>																			
T6	G12	E	U	39	3.56	2.18	20153	CMH39TUVUCU830G12	C130/M130	12		15,000	3,400	2,300	3000K	84	5		
	G12	E	U	70	3.56	2.18	20016	CMH70TU/830/G12	C139/M139	12		15,000	6,200	4,700	3000K	83	5		
<b>CMH® GU6.5</b>																			
T4	GU6.5	E	U	20	2.05	1.18	85086	CMH20T/U830GU6.5	C156/M156	12		12,000	1,615	1,066	3000K	81	5		
	GU6.5	E	U	39	2.05	1.18	71484	CMH39T/U930GU6.5	C130/M130	12		10,000	3,400	2,300	3000K	88	5		
<b>CMH® Mini's</b>																			
T4.5	G8.5	E	U	20	3.37	2.00	92696	CMH20TCU830/G8.5	C156/M156	12		12,000	1,650	1,090	3000K	81	5		
	G8.5	E	U	39	3.37	2.00	90352	CMH39TCU830/G8.5	C130/M130	12		16,500	3,400	2,300	3000K	84	5		
	G8.5	E	U	70	3.37	2.00	92585	CMH70TCU830G8.5	C139/M139	12		15,000	6,200	4,400	3000K	83	5		

## High Pressure Sodium Lamps

Bulb Shape	Base Type	LET	OP	Watts	MOL (In)	LCL (In)	Order Code	Description	ANSI Ballast Type	Car-ton Qty <sup>1</sup>	Rated Life (hrs*)	Initial Lumens	Mean Lumens	Color Temp.	CRI	Warning Notice	Type B LED Replacement	
																	Order Code	Description
<b>70-1000 Watts</b>																		
B17	E26	O	U	70	5.43	3.43	11339	LU70/MED/ECO	S62	6	24,000+	6,400	5,450	1900K	22	6	9311214	LED35ED17/730
ED23.5	E39	O	U	70	7.75	5.00	85368	LU70/H/ECO	S62	12	24,000+	6,400	5,450	1900K	22	6	93303384	LED/LC/ED17/7SC
B17	E26	O	U	100	5.50	3.43	13250	LU100/MED/ECO	S54	6	24,000+	9,500	8,550	2000K	22	6	93303384	LED/LC/ED17/7SC
ED23.5	E39	O	U	100	7.75	5.00	85369	LU100/H/ECO	S54	12	24,000+	9,500	8,550	2000K	22	6	93312106	LED/LC/ED23.5/730
B17	E26	O	U	150	5.75	3.50	13252	LU150/MED/ECO	S55	6	24,000+	16,000	14,400	2000K	22	6	93303384	LED/LC/ED17/7SC
ED23.5	E39	O	U	150	7.75	5.00	85371	LU150/55/H/ECO	S55	12	24,000+	16,000	14,400	2000K	22	6	93112196	LED80ED23.5/730
ED18	E39	O	U	200	9.75	5.75	85372	LU200/H/ECO	S66	12	24,000+	22,000	19,800	2100K	22	6	93312096	LED180ED18/730
	E39	O	U	250	9.75	5.75	85377	LU250/H/ECO	S50	12	24,000+	28,000	25,200	2100K	22	6	93312096	LED180ED18/730
	E39	O	U	400	9.75	5.75	85379	LU400/H/ECO	S51	12	24,000+	51,000	45,000	2100K	22	6	93312096	LED180ED18/730
E25	E39	O	U	1000	15.06	8.75	44058	LU1000/ECO	S52	6	24000+	130,000	117,000	2100K	22	7		

## Mercury Lamps



Bulb Shape	Base Type	LET	OP	Watts	MOL (In)	LCL (In)	Order Code	Description	ANSI Ballast Type	Car-ton Qty <sup>1</sup>	Rated Life (hrs*)	Initial Lumens	Mean Lumens	Color Temp.	CRI	Warning Notice	Type B LED Replacement	
																	Order Code	Description
<b>100-400 Watts</b>																		
ED23.5	E39	O	U	100	7.50	5.00	22575	HR100DX38	H38	12	20,000	4,000	2,800	3900K	50	8	93303384	LED/LC/ED17/7SC
	E39	O	U	175	8.25	5.00	24062	HR175DX39	H39	12	20,000	7,800	6,630	3900K	50	8	22679	LED50ED23.5/740
ED28	E39	O	U	250	8.25	5.00	32127	HR250DX37	H37	12	20,000	11,200	7,840	3900K	50	8	22635	LED80ED23.5/740
ED37	E39	O	U	400	11.31	7.00	23998	HR400DX33	H33	6	20,000	22,600	15,800	3900K	50	8	22611	LED150ED28/740

<sup>1</sup> Minimum order quantity = Carton Qty



**1** WARNING NOTICE NO. 1:

** WARNING**

**Risk of electric shock**

- Turn power off before inspection, installation, or removal
- Do not use where directly exposed to water or outdoors without an enclosed fixture

**Risk of fire**

- Keep combustible materials away from lamp
- Use in fixture rated for this product

**A damaged lamp emits UV radiation which may cause eye/skin injury**

- Turn power off if glass bulb is broken. Remove and dispose of lamp.

**Unexpected lamp rupture may cause injury, fire, or property damage**

- Turn lamp off at least once for 15 minutes per week. **FAILURE TO COMPLY INCREASES THE RISK OF RUPTURE.**
- Do not use beyond rated life. Beyond rated life, light output diminishes while energy consumption and risk of lamp rupture increases.
- Do not use lamp if outer glass is scratched or broken
- Do not use where directly exposed to water or outdoors without an enclosed fixture
- Lamps with E-rated ANSI codes must be operated in enclosed fixtures -- See Instructions
- Do not store flammable materials near/below S-rated lamp in open fixture
- Use only properly rated ballast
- Do not exceed rated voltage
- Do not turn on lamp until fully installed
- Operate lamp only in specified position
- If used on a dimming system, see instructions.

**INSTRUCTIONS**

**LAMP OPERATING CHARACTERISTICS**

This is a discharge lamp and requires some time to restart and come to full brightness after a power interruption.

**RELAMP FIXTURES AT OR BEFORE THE END OF RATED LIFE.**

Beyond rated life, light output diminishes while energy consumption and risk of lamp rupture increases.

**SPECIFIED OPERATING POSITIONS**

VBU - Base up  $\pm 15^\circ$       VBD - Base down  $\pm 15^\circ$   
 HOR - Horizontal  $\pm 15^\circ$       HOR/PA - Horizontal  $\pm 75^\circ$   
 U - Universal

All lamps are rated for enclosed fixtures, except lamps with S-rated ANSI codes operated in vertical position only (Base Up or Base Down),  $\pm 15$  degrees, can be used in an open fixture.

Match ANSI code of lamp to code on ballast or luminaire.

Use in luminaire which comply with UL1598 or IEC 60598. When used, fixture lens/diffuser material must be able to contain fragments of hot quartz or glass (up to 1100°C).

Electrically insulate any metal to bulb support in luminaire to avoid decomposition of glass.

For total load, add auxiliary watts to lamp watts.

Not for use with lampholders that have stainless steel center contacts to avoid lamp or lampholder damage due to arcing. (360-1000W only)

**FOR USE ON DIMMING SYSTEMS**

Contact your local Current sales representative



** CAUTION**

**Risk of burn**

- Allow lamp to cool before handling
- Do not turn on lamp until fully installed

**Lamp may shatter and cause injury if broken**

- Wear safety glasses and gloves when handling lamp
- Do not use lamp if outer glass is scratched or broken
- Dispose of lamp in a closed container
- Do not use excessive force when installing lamp
- **CAUTION:** Do not stare at light source. May be harmful to the eyes. Not applicable to diffuse coated bulbs.

** LAMP CONTAINS MERCURY **

Manage in Accord with Disposal Laws.  
 See [www.lamprecycle.org](http://www.lamprecycle.org) or 1-800-327-0097

**R WARNING:** This lamp can cause serious skin burn and eye inflammation from shortwave ultraviolet radiation if outer envelope of the lamp is broken or punctured. Do not use where people will remain for more than a few minutes unless adequate shielding or other safety precautions are used. Lamps that will automatically extinguish when the outer envelope is broken or punctured are commercially available. This lamp certified to comply with FDA radiation performance standards, 21 CFR Subchapter J. USA: 21 CFR 1040.30 Canada: C.R.C., c. 1370



- 2** WARNING NOTICE NO. 2: Lamp contains Radioactive Material Thorium
- 3** WARNING NOTICE NO. 3: Lamp contains Radioactive Materials Thorium and Kr-85
- 4** WARNING NOTICE NO. 4:

** WARNING**

**Risk of electric shock**

- Turn power off before inspection, installation, or removal
- Do not use where directly exposed to water or outdoors without an enclosed fixture

**Risk of fire**

- Keep combustible materials away from lamp
- Use in fixture rated for this product

**A damaged lamp emits UV radiation which may cause eye/skin injury**

- Turn power off if glass bulb is broken. Remove and dispose of lamp.

**Unexpected lamp rupture may cause injury, fire, or property damage**

- Do not use beyond rated life. Beyond rated life, light output diminishes while energy consumption increases.
- Do not use lamp if outer glass is scratched or broken
- Do not use where directly exposed to water or outdoors without an enclosed fixture
- Turn lamp off at least once for 15 minutes per week
- Do not store flammable materials near/below lamp
- Use only properly rated ballast
- Do not exceed rated voltage
- Do not turn on lamp until fully installed
- Operate lamp only in specified position
- If used on a dimming system, see instructions.

** CAUTION**

**Risk of burn**

- Allow lamp to cool before handling
- Do not turn on lamp until fully installed

**Lamp may shatter and cause injury if broken**

- Wear safety glasses and gloves when handling lamp
- Do not use lamp if outer glass is scratched or broken
- Dispose of lamp in a closed container
- Do not use excessive force when installing lamp
- **CAUTION:** Do not stare at light source. May be harmful to the eyes. Not applicable to diffuse coated bulbs.

**INSTRUCTIONS**

**LAMP OPERATING CHARACTERISTICS**

This is a discharge lamp and requires some time to restart and come to full brightness after a power interruption.

Relamp fixtures at or before the end of rated life. Beyond rated life, light output diminishes while energy consumption increases.

**SPECIFIED OPERATING POSITIONS**

VBU - Base up  $\pm 15^\circ$       VBD - Base down  $\pm 15^\circ$   
 U - Universal

Match ANSI code of lamp to code on ballast or luminaire.



Use in luminaire which comply with UL1598 or IEC 60598. Lamps are suitable for open or enclosed fixtures.

Electrically insulate any metal to bulb support in luminaire to avoid decomposition of glass.

For total load, add auxiliary watts to lamp watts.

**FOR USE ON DIMMING SYSTEMS**

Most vertical operating lamps are suitable for dimming. Contact your local Current sales representative

** LAMP CONTAINS MERCURY **

Manage in Accord with Disposal Laws.  
 See [www.lamprecycle.org](http://www.lamprecycle.org) or 1-800-327-0097

**R WARNING:** This lamp can cause serious skin burn and eye inflammation from shortwave ultraviolet radiation if outer envelope of the lamp is broken or punctured. Do not use where people will remain for more than a few minutes unless adequate shielding or other safety precautions are used. Lamps that will automatically extinguish when the outer envelope is broken or punctured are commercially available. This lamp certified to comply with FDA radiation performance standards, 21 CFR Subchapter J. USA: 21 CFR 1040.30 Canada: C.R.C., c. 1370



## 5 WARNING NOTICE NO. 5:

### **WARNING**

#### **Risk of electric shock**

- Turn power off before inspection, installation, or removal
- Do not use where directly exposed to water or outdoors without an enclosed fixture

#### **Risk of fire**

- Keep combustible materials away from lamp
- Use in fixture rated for this product
- Use fused or thermally protected ballast - see instructions

#### **Unexpected lamp rupture may cause injury, fire, or property damage**

- Do not exceed rated voltage
- Do not use where directly exposed to water or outdoors without an enclosed fixture
- Do not use lamp if outer glass is scratched or broken
- Use only properly rated ballast
- Do not store flammable materials near/below lamp
- Do not use beyond rated life
- Do not turn on lamp until fully installed

### **CAUTION**

#### **Risk of burn**

- Allow lamp to cool before handling
- Do not turn on lamp until fully installed

#### **Lamp may shatter and cause injury if broken**

- Wear safety glasses and gloves when handling lamp
- Do not use lamp if outer glass is scratched or broken
- Dispose of lamp in a closed container
- Do not use excessive force when installing lamp

### **INSTRUCTIONS**

#### **LAMP OPERATING CHARACTERISTICS**

This is a discharge lamp and requires some time to restart and come to full brightness after a power interruption.

For total load, add auxiliary watts to lamp watts

Relamp fixtures at or before the end of rated life. Beyond rated life, light output diminishes while energy consumption increases.

If power supply dips or is interrupted, lamps may extinguish and not restart. Turn off power supply for 10-15 minutes and allow lamp to fully cool. Lamps will restart when power is restored

Use on ballasts or systems that are either resistant to or will shut off in event of rectification

Lamp may be operated in any position.

UV Control is a quartz material that effectively cuts UVB and UVC radiation.

All MR16 and 20W PAR use only on electronic ballast.

Lamps designated as CMH70/PAR30 do not require thermally protected ballasts



### **LAMP CONTAINS MERCURY**



Manage in Accord with Disposal Laws.  
See [www.lamprecycle.org](http://www.lamprecycle.org) or 1-800-327-0097

This product is in conformity with performance standards for high intensity mercury vapor lamps products under 21 CFR 1040, except with respect to those characteristics authorized by Variance Number FDA-2021-V-0995 effective September 27, 2021.

Arc tube fill gas contains Radioactive Material Kr-85



## 6 WARNING NOTICE NO. 6:

### **WARNING**

#### **Risk of electric shock**

- Turn power off before inspection, installation, or removal
- Do not use where directly exposed to water or outdoors without an enclosed fixture

#### **Risk of fire**

- Keep combustible materials away from lamp
- Use in fixture rated for this product

#### **Contains sodium – chemical burn risk**

- Avoid skin contact with broken pieces

#### **Unexpected lamp rupture may cause injury, fire, or property damage**

- Do not exceed rated voltage
- Do not use where directly exposed to water or outdoors without an enclosed fixture
- Do not use lamp if outer glass is scratched or broken
- Use only properly rated ballast
- Do not store flammable materials near/below lamp
- Do not turn on lamp until fully installed

### **CAUTION**

#### **Risk of burn**

- Allow lamp to cool before handling
- Do not turn on lamp until fully installed

#### **Lamp may shatter and cause injury if broken**

- Wear safety glasses and gloves when handling lamp
- Do not use lamp if outer glass is scratched or broken
- Dispose of lamp in a closed container
- Do not use excessive force when installing lamp

### **INSTRUCTIONS**

#### **LAMP OPERATING CHARACTERISTICS**

This is a discharge lamp and requires some time to restart and come to full brightness after a power interruption.

HPS lamps may be operated in any burn position.

Match ANSI code of lamp to code on ballast or luminaire.

Use in luminaire which comply with UL1598 or IEC 60598.

Electrically insulate any metal to bulb support in luminaire to avoid decomposition of glass.

For total load, add auxiliary watts to lamp watts.

Not for use with lampholders that have stainless steel center contacts to avoid lamp or lampholder damage due to arcing. (400W only)

#### **FOR USE ON DIMMING SYSTEMS**

Contact your local Current sales representative



### **LAMP CONTAINS MERCURY**



Manage in Accord with Disposal Laws.  
See [www.lamprecycle.org](http://www.lamprecycle.org) or 1-800-327-0097



## 7 WARNING NOTICE NO. 7:

### **WARNING**

#### **Risk of electric shock**

- Turn power off before inspection, installation, or removal
- Do not use where directly exposed to water or outdoors without an enclosed fixture

#### **Risk of fire**

- Keep combustible materials away from lamp
- Use in fixture rated for this product - see instructions

#### **Contains sodium – chemical burn risk**

- Avoid skin contact with broken pieces

#### **Unexpected lamp rupture may cause injury, fire, or property damage**

- Do not exceed rated voltage
- Do not use where directly exposed to water or outdoors without an enclosed fixture
- Do not use lamp if outer glass is scratched or broken
- Use only properly rated ballast
- Do not store flammable materials near/below lamp
- Do not turn on lamp until fully installed

### **CAUTION**

#### **Risk of burn**

- Allow lamp to cool before handling
- Do not turn on lamp until fully installed

#### **Lamp may shatter and cause injury if broken**

- Wear safety glasses and gloves when handling lamp
- Do not use lamp if outer glass is scratched or broken
- Dispose of lamp in a closed container
- Do not use excessive force when installing lamp

### **INSTRUCTIONS**

#### **LAMP OPERATING CHARACTERISTICS**

This is a discharge lamp and requires some time to restart and come to full brightness after a power interruption.

Match ANSI code of lamp to code on ballast or luminaire. Or use suitable ballast and ignitor that complies with IEC 60923 and IEC 60927.

Use in luminaire which comply with UL1598 or IEC 60598.

Fixtures must have a specially designed mogul base lamp holder and must support the end of the lamp.

In vertical base up applications with no vibration and/or shock, a tempered glass enclosed fixture may be used in place of the lamp end support.

Electrically insulate any metal to bulb support in luminaire to avoid decomposition of glass.

For total load, add auxiliary watts to lamp watts.

Not for use with lampholders that have stainless steel center contacts to avoid lamp or lampholder damage due to arcing.

#### **FOR USE ON DIMMING SYSTEMS**

Contact your local Current sales representative



### **LAMP CONTAINS MERCURY**



Manage in Accord with Disposal Laws.  
See [www.lamprecycle.org](http://www.lamprecycle.org) or 1-800-327-0097



## 8 WARNING NOTICE NO. 8:

### WARNING

#### Risk of electric shock

- Turn power off before inspection, installation, or removal
- Do not use where directly exposed to water or outdoors without an enclosed fixture

#### Risk of fire

- Keep combustible materials away from lamp
- Use in fixture rated for this product

#### A damaged lamp emits UV radiation which may cause eye/skin injury

- Turn power off if glass bulb is broken. Remove and dispose of lamp.

#### Unexpected lamp rupture may cause injury, fire, or property damage

- Do not exceed rated voltage
- Do not use where directly exposed to water or outdoors without an enclosed fixture
- Do not use lamp if outer glass is scratched or broken
- Use only properly rated ballast
- Do not store flammable materials near/below lamp
- Do not use beyond rated life
- Do not turn on lamp until fully installed

### CAUTION

#### Risk of burn

- Allow lamp to cool before handling
- Do not turn on lamp until fully installed

#### Lamp may shatter and cause injury if broken

- Wear safety glasses and gloves when handling lamp
- Do not use lamp if outer glass is scratched or broken
- Dispose of lamp in a closed container
- Do not use excessive force when installing lamp

### INSTRUCTIONS

#### LAMP OPERATING CHARACTERISTICS

This is a discharge lamp and requires some time to restart and come to full brightness after a power interruption.

Lamp may be operated in any position.

#### For Consumer Packaging - /CP

Do not use in standard incandescent light bulb sockets. See instructions inside this carton

For total load, add auxiliary watts to lamp watts

Relamp fixtures at or before the end of rated life.

Beyond rated life, light output diminishes while energy consumption increases.

**SYSTEM CHARACTERISTICS** -- Use Current Approved Ballast/Control Gear. For further information contact your local Current sales representative



### LAMP CONTAINS MERCURY



Manage in Accord with Disposal Laws.  
See [www.lamprecycle.org](http://www.lamprecycle.org) or 1-800-327-0097

**R WARNING:** This lamp can cause serious skin burn and eye inflammation from shortwave ultraviolet radiation if outer envelope of the lamp is broken or punctured. Do not use where people will remain for more than a few minutes unless adequate shielding or other safety precautions are used. Lamps that will automatically extinguish when the outer envelope is broken or punctured are commercially available. This lamp certified to comply with FDA radiation performance standards, 21 CFR Subchapter J. USA: 21 CFR 1040.30 Canada: C.R.C., c. 1370

# Compact Fluorescent Lamps



**Compact Fluorescent lighting** offers high light output and long life for all your commercial plug-in applications.

## Reference Guide | Bulb Identification

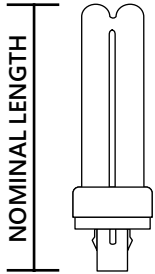

**NOMINAL LENGTH:**

Overall length including base or pins.

**Note:** Lamp drawings are not drawn to scale. Be sure to check size and dimension information when identifying each lamp.

To convert inches to millimeters, multiply the dimension (in inches) by 25.4 (i.e. 1.5" x 25.4 = 38.1 mm).

## Lamp Drawings (not drawn to scale)

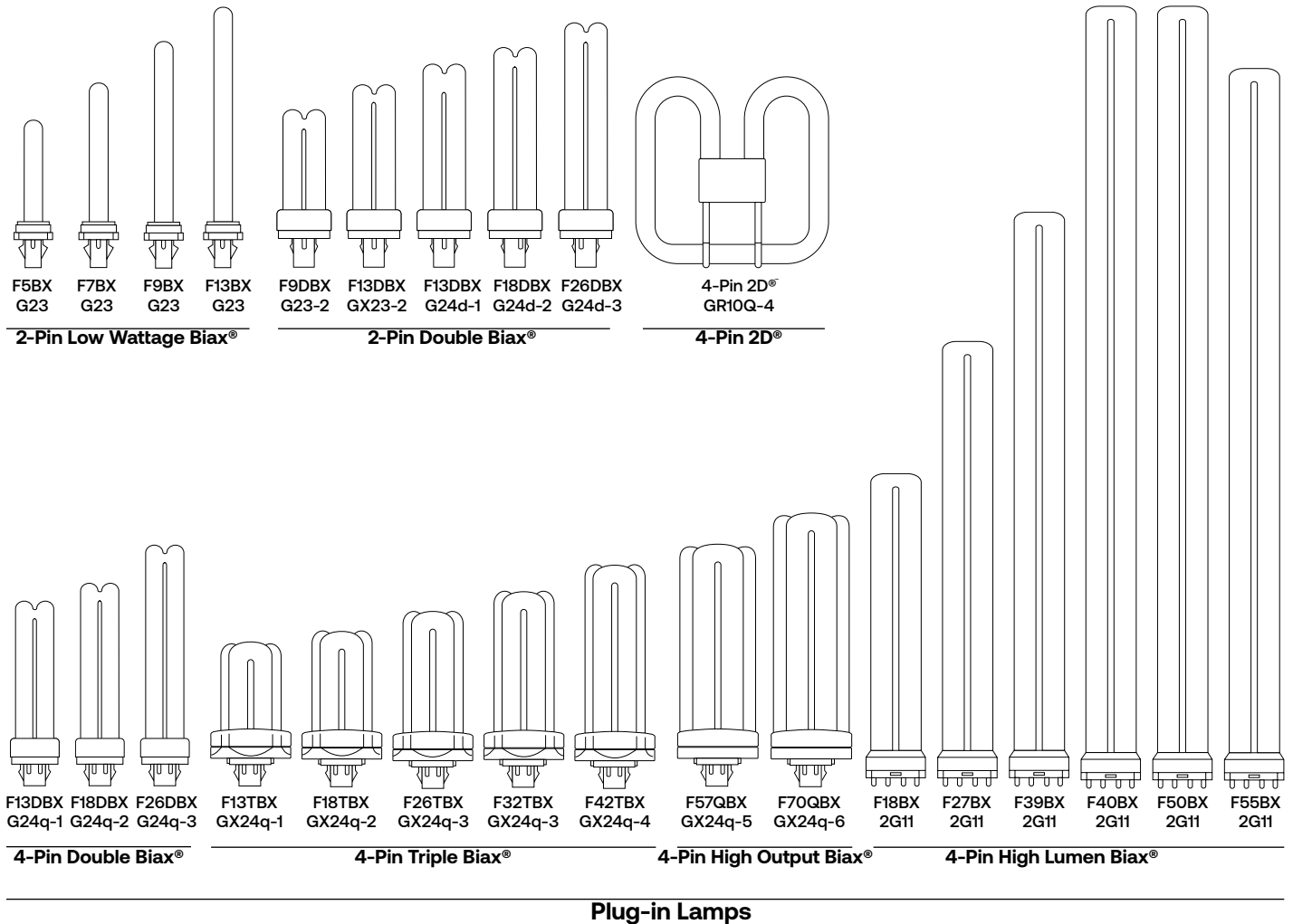

### Plug-in Lamps

# Compact Fluorescent Lamps



## Base Identification (not drawn to scale)

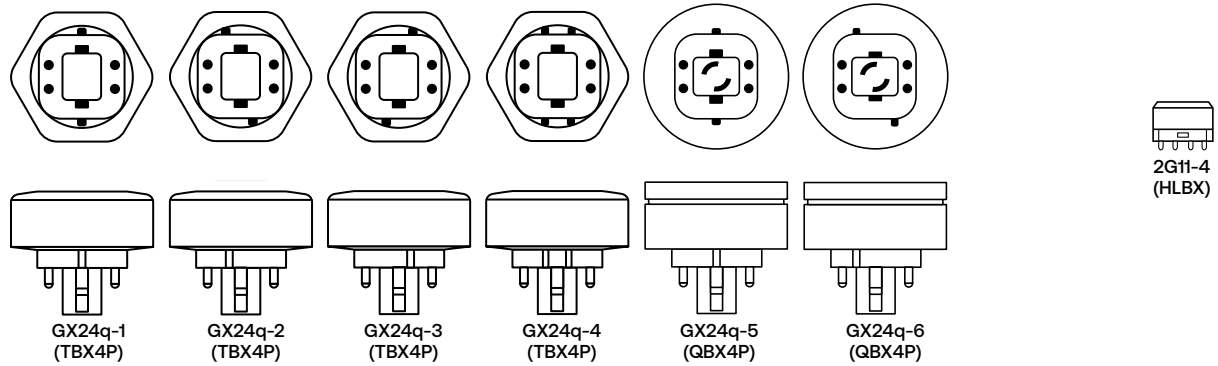
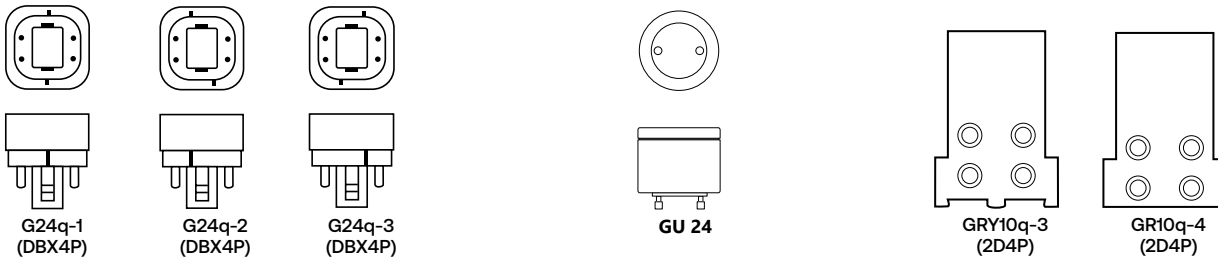
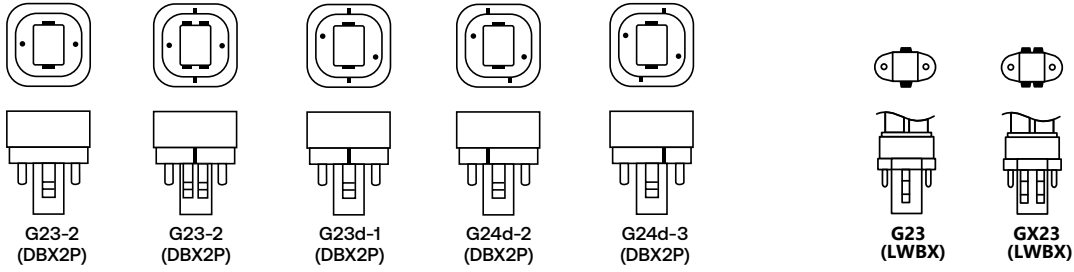

# Compact Fluorescent Lamps



## Catalog Logic:

The following terms and descriptions can help you when checking Compact Fluorescent lamp specifications and when ordering products. Within each product line, lamps are divided into families and listed by base and wattage.

Base Type	Watts	Nominal Length (in.)	Order Code	Description	Car- ton Qty	Rated Life (hrs.)	Initial Lumens	Mean Lumens	Color Temp.	CRI	Order Code	Description
GX23	13	7.0	97573	F13BX/827/ECO	100	10,000	825	710	2700K	82	91404	LED5GX23/827 (Type A)

**Watts:**  
Energy used (as defined by FTC Lamp Label Rules). To estimate energy consumption (kWh), multiply watts x hours of use and divide by 1000.

**Nominal Length (in):**  
Lamp length including base and/or pins.

**Order Code:**  
Use the order code when ordering to ensure that you receive the exact product you require.

**Means Lumens:**  
Lamp light output at 40% of rated lamp life or 8K hours for lamps exceeding 20K hours life.

**Initial Lumens:**  
Lamp light output after the initial 100 hours of operation.

**Rated Life (hours):**  
Life (as defined by FTC Lamp Label Rules) is rated life in hours.

**Carton Quantity:**  
Number of lamps packed in a carton

**Description:**  
Lamp Model Description

**Color Temperature – Kelvins (K):**  
A measure of the visual "warmth" or "coolness" of the light from the lamp. The higher the value, the whiter or "cooler" the light appears.

**Color Rendering Index (CRI or R):**  
An indication of the ability of the lamp to render object colors in a normal natural way. The higher the number (0-100), the better the color appearance

**LED Replacement:**  
Current offers a wide range of LED replacement lamps. The LED lamp models are provided as general guidance. Often, there will be more than one LED Lamp that may be used to replace a Traditional lamp. For Traditional lamps that operated off a ballast, the ballast bypass (UL Type B) LED option is given unless otherwise noted. The application should be considered when selecting an LED replacement lamp. Sometimes, Traditional lamps do not have a suitable LED replacement due to special application considerations, such as very high heat. Contact Current for additional guidance if the appropriate LED solution is unclear.

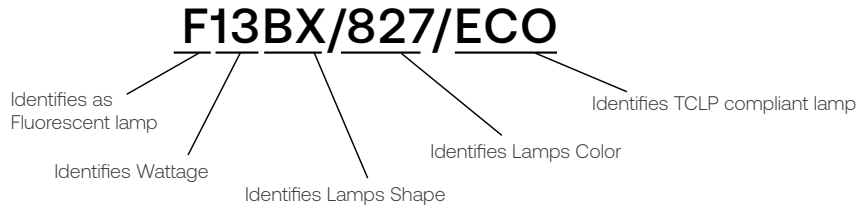

Lamp Contains Mercury.  
Manage in Accord with Disposal Laws.  
See [www.lamprecycle.org](http://www.lamprecycle.org) or 1-800-327-0097

# Compact Fluorescent Lamps



**\*\*Fluorescent Phase-Out Regulations\*\*:** Several US states have enacted legislation that prohibit/will prohibit the sale of Linear and Compact Fluorescent Lamps within their state. For more information including effective dates, please visit [www.LED.com/lamplegislation](http://www.LED.com/lamplegislation)

## Plug-In Lamps

											Type B LED Replacement	
Base Type	Watts	Nominal Length (in.)	Order Code	Description	Car-ton Qty	Rated Life (hrs.)	Initial Lumens	Mean Lumens	Color Temp.	CRI	Order Code	Description
<b>2-Pin Low Wattage Biax*</b>												
GX23	13	7.0	97573	F13BX/827/ECO	10	10,000	825	710	2700K	82	93312495	LED5BGX23/827
GX23	13	7.0	97569	F13BX/835/ECO	10	10,000	825	710	3500K	82	93312507	LED5BGX23/835
GX23	13	7.0	97571	F13BX/841/ECO	10	10,000	825	710	4100K	82	93312513	LED5BGX23/840
<b>4-Pin High Lumen Biax*</b>												
2G11	18	9.0	16053	F18BX/SPX35 10PK	10	10,000	1,200	1,080	3500K	82		
2G11	18	9.0	16940	F18BX/SPX41 10PK	10	10,000	1,200	1,080	4100K	82		
2G11	39	16.5	28393	F39BXSPX35RS10PK	10	12,000	2,850	2,565	3500K	82		
2G11	39	16.5	28458	F39BXSPX41RS10PK	10	12,000	2,850	2,565	4100K	82		
2G11	40	22.5	16953	F4030BXSPX30 10P	10	20,000	3,150	2,840	3000K	82	93136025	LED17B2G11/830
2G11	40	22.5	16648	F40/30BX/SPX35	10	20,000	3,150	2,840	3500K	82	93136086	LED17B2G11/835
2G11	40	22.5	16954	F40/30BX/SPX41	10	20,000	3,150	2,840	4100K	82	93136087	LED17B2G11/840
2G11	25	21.5	75400	F40/25BX835/IS/WM	10	20,000	2,600	2,400	3500K	82	93136086	LED17B2G11/835
2G11	55	20.7	31952	F55BX/835	25	20,000	4,800	4,080	3500K	82		
2G11	55	20.7	31953	F55BX/840	25	20,000	4,800	4,080	4100K	82		
<b>2-Pin Double Biax*</b>												
GX23-2	13	4.7	97586	F13DBX23/827/ECO	10	12,000	810	685	2700K	82	93312531	LED8BGX23-2-O/827
GX23-2	13	4.7	97588	F13DBX23/835/ECO	10	12,000	810	685	3500K	82	93312543	LED8BGX23-2-O/835
GX23-2	13	4.7	97589	F13DBX23/841/ECO	10	12,000	810	685	4100K	82	93312549	LED8BGX23-2-O/840
G24d-2	18	6.1	97577	F18DBX/827/ECO	10	12,000	1,250	980	2700K	82	Vertical: 93300088 Horizontal: 93300087	LED11BG24-V/8SC/120-347-4PK LED11BG24-H/8SC/120-347-4PK
G24d-2	18	6.1	97579	F18DBX/835/ECO	10	12,000	1,250	980	3500K	82	Vertical: 93300088 Horizontal: 93300087	LED11BG24-V/8SC/120-347-4PK LED11BG24-H/8SC/120-347-4PK
G24d-2	18	6.1	97580	F18DBX/841/ECO	10	12,000	1,250	980	4100K	82	Vertical: 93300088 Horizontal: 93300087	LED11BG24-V/8SC/120-347-4PK LED11BG24-H/8SC/120-347-4PK
G24d-3	26	6.7	97606	F26DBX/827/ECO	10	12,000	1,710	1,460	2700K	82	Vertical: 93300088 Horizontal: 93300087	LED11BG24-V/8SC/120-347-4PK LED11BG24-H/8SC/120-347-4PK
G24d-3	26	6.7	97608	F26DBX/835/ECO	10	12,000	1,710	1,460	3500K	82	Vertical: 93300088 Horizontal: 93300087	LED11BG24-V/8SC/120-347-4PK LED11BG24-H/8SC/120-347-4PK
G24d-3	26	6.7	97609	F26DBX/841/ECO	10	12,000	1,710	1,460	4100K	82	Vertical: 93300088 Horizontal: 93300087	LED11BG24-V/8SC/120-347-4PK LED11BG24-H/8SC/120-347-4PK
<b>4-Pin Double Biax*</b>												
G24q-1	13	5.0	97594	F13DBX/827/ECO4P	10	17,000	900	755	2700K	82	93300068	LED8BG24-O/827-4PK
G24q-1	13	5.0	97595	F13DBX/830/ECO4P	10	17,000	900	755	3000K	82	93300069	LED8BG24-O/830-4PK
G24q-1	13	5.0	97596	F13DBX/835/ECO4P	10	17,000	900	755	3500K	82	93300080	LED8BG24-O/835-4PK
G24q-1	13	5.0	97597	F13DBX/841/ECO4P	10	17,000	900	755	4100K	82	93300081	LED8BG24-O/840-4PK
G24q-2	18	5.8	97598	F18DBX/827/ECO4P	10	17,000	1,250	970	2700K	82	93300082	LED10BG24-O/827-4PK
G24q-2	18	5.8	97599	F18DBX/830/ECO4P	10	17,000	1,250	970	3000K	82	93300083	LED10BG24-O/830-4PK
G24q-2	18	5.8	97600	F18DBX/835/ECO4P	10	17,000	1,250	970	3500K	82	93300084	LED10BG24-O/835-4PK
G24q-2	18	5.8	97601	F18DBX/841/ECO4P	10	17,000	1,250	970	4100K	82	93300086	LED10BG24-O/840-4PK
G24q-3	26	6.4	97610	F26DBX/827/ECO4P	10	17,000	1,800	1,530	2700K	82	Vertical: 93300088 Horizontal: 93300087	LED11BG24-V/8SC/120-347-4PK LED11BG24-H/8SC/120-347-4PK
G24q-3	26	6.4	97611	F26DBX/830/ECO4P	10	17,000	1,800	1,530	3000K	82	Vertical: 93300088 Horizontal: 93300087	LED11BG24-V/8SC/120-347-4PK LED11BG24-H/8SC/120-347-4PK
G24q-3	26	6.4	97612	F26DBX/835/ECO4P	10	17,000	1,800	1,530	3500K	82	Vertical: 93300088 Horizontal: 93300087	LED11BG24-V/8SC/120-347-4PK LED11BG24-H/8SC/120-347-4PK
G24q-3	26	6.4	97613	F26DBX/841/ECO4P	10	17,000	1,800	1,530	4100K	82	Vertical: 93300088 Horizontal: 93300087	LED11BG24-V/8SC/120-347-4PK LED11BG24-H/8SC/120-347-4PK
<b>4-Pin Triple Biax*</b>												
GX24q-3	26	5.2	97614	F26TBX/827/A/ECO	10	17,000	1,800	1,530	2700K	82	Vertical: 93300088 Horizontal: 93300087	LED11BG24-V/8SC/120-347-4PK LED11BG24-H/8SC/120-347-4PK
GX24q-3	26	5.2	97615	F26TBX/830/A/ECO	10	17,000	1,800	1,530	3000K	82	Vertical: 93300088 Horizontal: 93300087	LED11BG24-V/8SC/120-347-4PK LED11BG24-H/8SC/120-347-4PK
GX24q-3	26	5.2	97616	F26TBX/835/A/ECO	10	17,000	1,800	1,530	3500K	82	Vertical: 93300088 Horizontal: 93300087	LED11BG24-V/8SC/120-347-4PK LED11BG24-H/8SC/120-347-4PK
GX24q-3	26	5.2	97617	F26TBX/841/A/ECO	10	17,000	1,800	1,530	4100K	82	Vertical: 93300088 Horizontal: 93300087	LED11BG24-V/8SC/120-347-4PK LED11BG24-H/8SC/120-347-4PK
GX24q-3	32	5.5	97629	F32TBX/827/A/ECO	10	17,000	2,400	2,040	2700K	82	Vertical: 93312489 Horizontal: 93312525	LED18BG24-V/8SC/120-347 LED18BG24-H/8SC/120-347
GX24q-3	32	5.5	97630	F32TBX/830/A/ECO	10	17,000	2,400	2,040	3000K	82	Vertical: 93312489 Horizontal: 93312525	LED18BG24-V/8SC/120-347 LED18BG24-H/8SC/120-347
GX24q-3	32	5.5	97631	F32TBX/835/A/ECO	10	17,000	2,400	2,040	3500K	82	Vertical: 93312489 Horizontal: 93312525	LED18BG24-V/8SC/120-347 LED18BG24-H/8SC/120-347
GX24q-3	32	5.5	97632	F32TBX/841/A/ECO	10	17,000	2,400	2,040	4100K	82	Vertical: 93312489 Horizontal: 93312525	LED18BG24-V/8SC/120-347 LED18BG24-H/8SC/120-347
GX24q-4	42	6.4	97633	F42TBX/827/A/ECO	10	17,000	3,200	2,690	2700K	82	Vertical: 93312489 Horizontal: 93312525	LED18BG24-V/8SC/120-347 LED18BG24-H/8SC/120-347
GX24q-4	42	6.4	97634	F42TBX/830/A/ECO	10	17,000	3,200	2,690	3000K	82	Vertical: 93312489 Horizontal: 93312525	LED18BG24-V/8SC/120-347 LED18BG24-H/8SC/120-347
GX24q-4	42	6.4	97635	F42TBX/835/A/ECO	10	17,000	3,200	2,690	3500K	82	Vertical: 93312489 Horizontal: 93312525	LED18BG24-V/8SC/120-347 LED18BG24-H/8SC/120-347
GX24q-4	42	6.4	97636	F42TBX/841/A/ECO	10	17,000	3,200	2,690	4100K	82	Vertical: 93312489 Horizontal: 93312525	LED18BG24-V/8SC/120-347 LED18BG24-H/8SC/120-347

\* Minimum order quantity = Carton Qty

Halogen Lighting offers unmatched quality of white light in compact sizes.

## Reference Guide | Bulb Identification

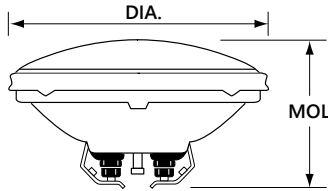

**DIA. in.:** Diameter of bulb at widest point.

**MOL in.:** Maximum Overall Length including base or pins.

**LCL in.:** Distance between the center of the filament and the Light Center Length reference plane.

**Note:** Lamp drawings are not drawn to scale. Be sure to check size and dimension information when identifying each lamp.

To convert inches to millimeters, multiply the dimension (in inches) by 25.4 (i.e. 1.5" x 25.4 = 38.1 mm).

## Filament Identification

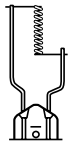

C-8  
CC-8

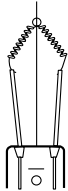

C-2V  
CC-2V

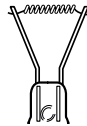

C-6  
CC-6

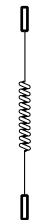

C-8  
CC-8

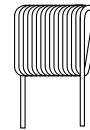

C-6  
Oval

## Base Identification (not drawn to scale)



2-Pin  
(Round)  
GX5.3



Can DC Bay



2-Pin  
GY6.35



Recessed  
Single Contact  
R7s



Screw  
Terminals



4" Leads

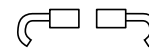

1" Ribbon  
Leads



6" Flex  
Leads



2-Pin  
GU4



2-Pin  
GU5.3



2-Pin  
G4



Turn & Lock  
GU7



GU10



G8



G9



2-Pin Pf



Min Screw  
E10



DC Bay  
BA15d



Min Cand  
E11



Med Screw  
E26

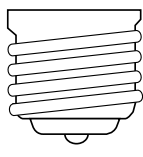

Mog Screw  
E39

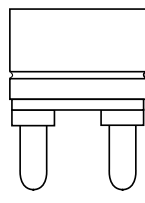

Mogul BiPost  
G38

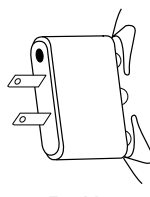

Ext. Mog  
End Pr  
GX16d

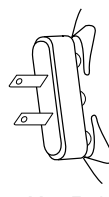

Mog End  
Pr  
GX16d

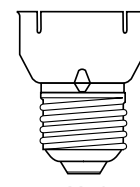

Med  
Skirted  
E26/50x39

# Halogen Lamps



## Catalog Logic:

The following terms and descriptions can help you when checking Halogen lamp specifications and when ordering products. Within each product line, lamps are divided into families and listed by wattage.

### Bulb Shape:

followed by its size (the maximum diameter of the bulb expressed in eighths of an inch).

### Order Code:

Use the order code when ordering to ensure that you receive the exact product you require.

### LCL (in):

Distance between the center of the filament and the Light Center Length reference plane, in inches.

### Color Temperature – Kelvins (K):

A measure of the visual "warmth" or "coolness" of the light from the lamp. The higher the value, the whiter or "cooler" the light appears.

### Watts:

Energy used (as defined by FTC Lamp Label Rules). To estimate energy consumption (kWh), multiply watts x hours of use and divide by 1000.

### Filament Design:

Filaments are designated by a letter combination in which C is coiled wire filament, CC is a coiled wire that is itself wound into a larger coil and SR is straight ribbon filament. Numbers represent the type of filament-support arrangement.

### Rated Life (hours):

Life (as defined by FTC Lamp Label Rules) is rated life in hours.

### CBCP (Center beam Candlepower):

For reflector-type lamps, Center Beam Candlepower is the intensity (candelas) at the center of maximum intensity of the beam. Used only for ConstantColor® CMH® Metal Halide Lamps

### Base:

The type of base

### Description:

Lamp Model Description

### Carton Quantity:

Number of lamps packed in a carton

### MOL (in):

Maximum Overall Length in inches

### Initial Lumens:

Lamp light output after the initial 100 hours of operation.

### Additional Information:

Typical application and/or other important information.

Bulb Shape	Base Type	Watts	Order Code	Description	Volts	Carton Qty	Filament Design	MOL (In)	LCL (In)	Rated Life (hrs*)	Lumens Initial	Color Temp.	CBCP	Additional Information
Standard MR16	PAR36	Scrw Term	19877	35PAR36/H/FL30	12	12	C-6	2.75		4,000	250	3050K	900	Floodlight

## 35PAR36/H/FL30

Identifies as lamp's wattage

Identifies the lamp shape and the bulb diameter in eighths of inches

Identifies the lamp type (Halogen)

Beam Angle (30 = 30 degrees)

Identifies beam angle type (Flood or Spot), code may also include base type or packaging information

# Halogen Lamps



## Specialty Lamps

Bulb Shape	Base Type	Watts	Order Code	Description	Volts	Carton Qty <sup>1</sup>	Filament Design	MOL (In)	LCL (In)	Rated Life (hrs*)	Lumens Initial	Color Temp.	CBCP	Additional Information
<b>Compact PAR36</b>														
PAR36	Scrw Term		19877	35PAR36/H/FL30	12	12	C-6	2.75		4,000	250	3050K	900	Floodlight
<b>Standard MR11</b>														
MR11	2-Pin G4	20	30773	Q20MR11/NFL30	12	10	C-6	1.38		3,500		2900K	600	Soft White
<b>Low Voltage</b>														
T3	2-Pin GY6.35	35	34708	Q35T3/12V/CL	12	100	C-6	1.75 cm		2,000	550			Clear, 12V
<b>Halogen G9</b>														
T4	G9	25	16754	Q25G9/CD	120	5	CC-8	1.77	1.26	3,000	240	6250K		Carded
	G9	40	16755	Q40G9/CD	120	5	CC-8	1.77	1.26	3,000	480	2750K		Carded
<b>Halogen Double Contact Bayonet (BA15d)</b>														
T4	BA15d	100	15508	Q100CL/DC	120	6	CC-8	2.44	1.38	2,000	1,600	2950K		Clear
	BA15d	150	43693	Q150CL/DC	120	6	CC-8	2.50	1.38	2,000	2,800	2950K		Clear
	BA15d	250	43697	Q250CL/DC	120	6	CC-8	3.00	1.63	2,000	5,000	2950K		Clear
<b>Halogen Recessed Single Contact (R7s)</b>														
T3	R7s	100	22489	Q100T3/CL/CD 5PK	210	60	C-8	3.13	1.25	1,500	1,650	2950K		Clear, Horizontal, Carded
	R7s	150	19378	Q150T3/CL/CD 5PK	120	60	C-8	3.13	1.25	1,500	2,400	2950K		Clear, Horizontal, Carded
T2.5	R7s	300	43703	Q300T3/CL-6PK	120	144	C-8	4.69	2.25	2,000	5,950	2950K		Clear, Horizontal
	R7s	500	23731	Q500T3/CL	120	12	C-8	4.69	2.25	2,000	11,100	3000K		Clear, Horizontal
	R7s	500	23733	Q500T3/CL	130/120	12	C-8	4.69	2.25	2,000	10,550	3000K		Clear, Horizontal
<b>Halogen Miniature Candelabra Screw (E11)</b>														
T4	Mini-Cand	100	15507	Q100CL/MC	120	6	CC-8	2.81	1.38	2,000	1,600	2950K		Clear
	Mini-Cand	150	43694	Q150CL/MC	120	6	CC-8	3.00	1.38	2,000	2,800	2950K		Clear
	Mini-Cand	250	43699	Q250CL/MC	120	6	CC-8	3.16	1.63	2,000	5,000	2950K		Clear
	Mini-Cand	250	43700	Q250CL/MC	130/120	6	CC-8	3.16	1.63	2,000	5,000	2950K		Clear

<sup>1</sup> Minimum order quantity = Carton Qty

# Incandescent Lamps



**Incandescent Lighting** is the familiar, dependable light source you've known for decades.

## Reference Guide | Bulb Identification

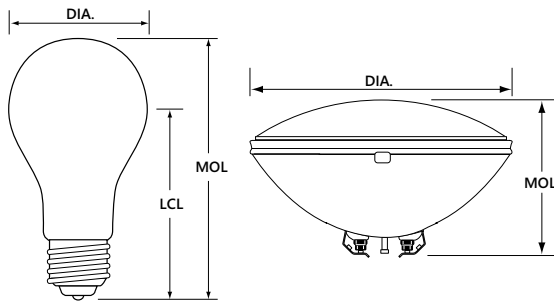

**DIA:** Diameter of bulb at widest point.

**MOL:** Maximum Overall Length including base or pins.

**LCL:** Distance between the center of the arc tube and the Light Center Length reference plane.

**Note:** Lamp drawings are not drawn to scale. Be sure to check size and dimension information when identifying each lamp.

To convert inches to millimeters, multiply the dimension (in inches) by 25.4 (i.e. 1.5" x 25.4 = 38.1 mm).

## Filament Identification

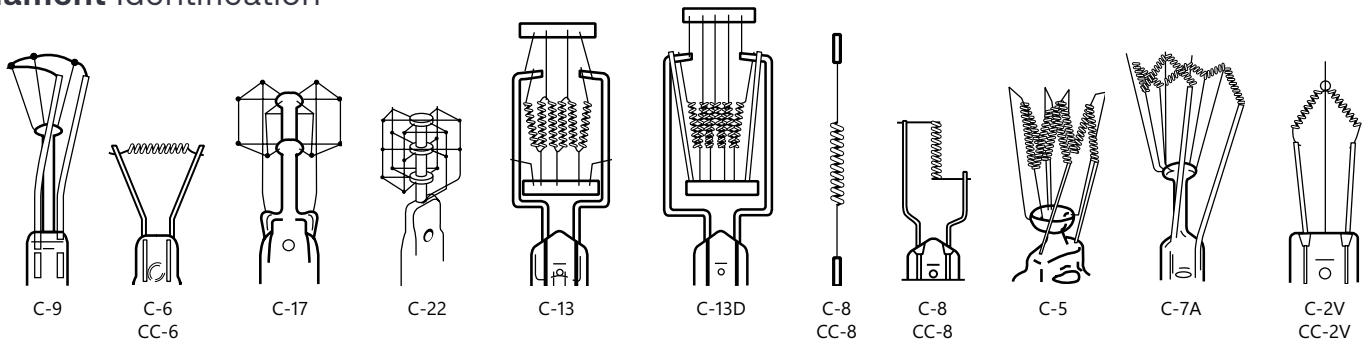

## Base Identification (not drawn to scale)

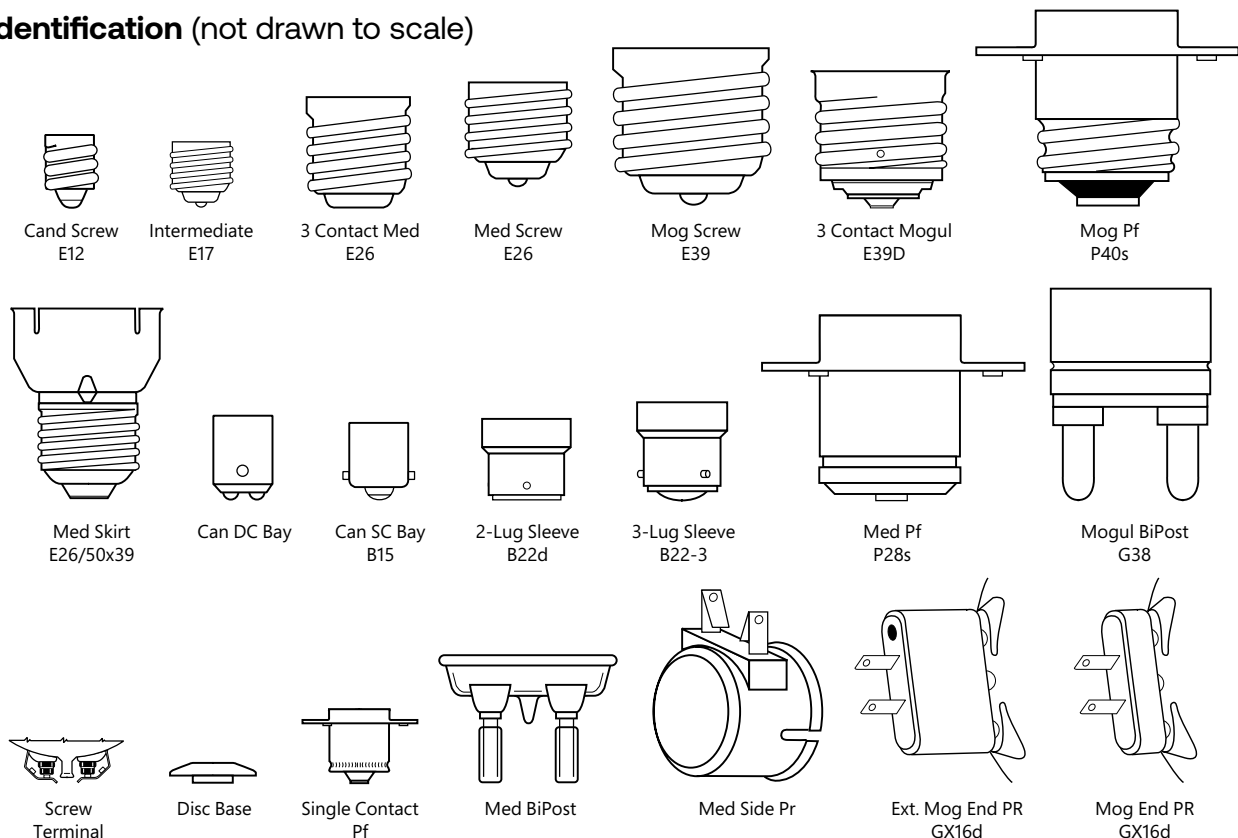

# Incandescent Lamps



## Lamp Drawings (not drawn to scale)

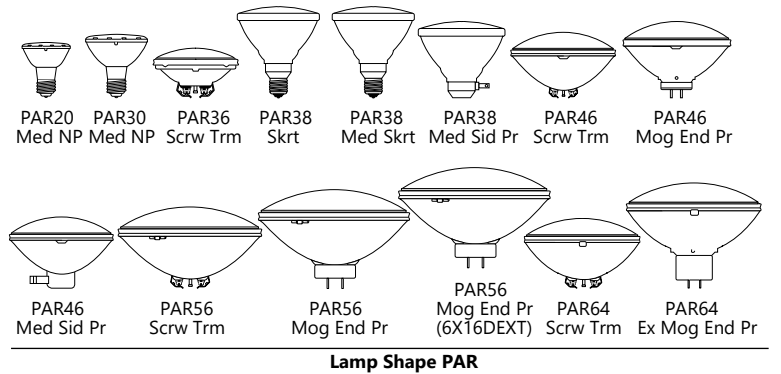
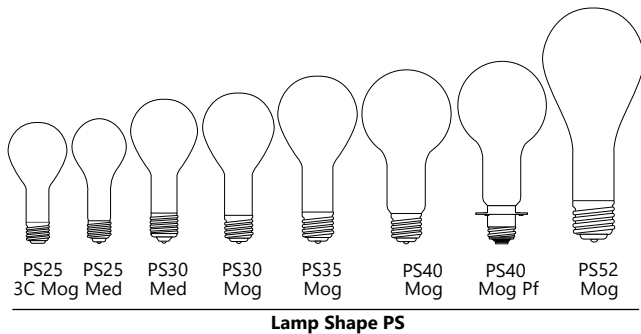
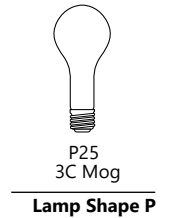
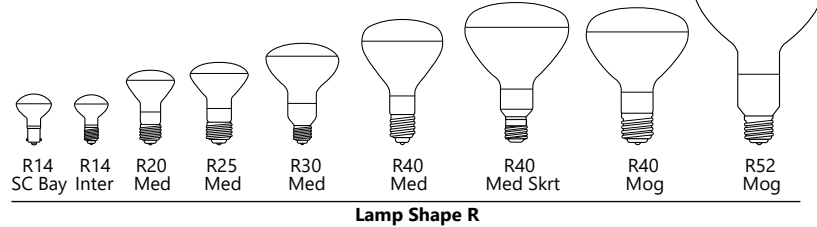
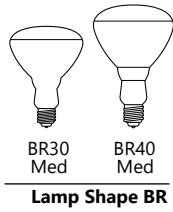
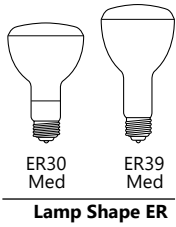
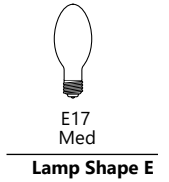
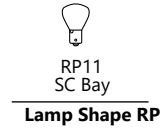
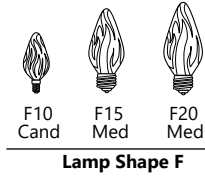
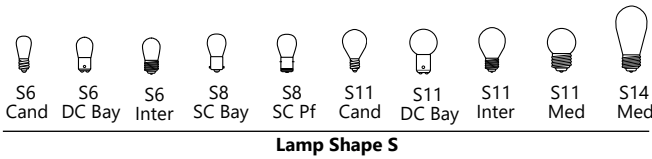
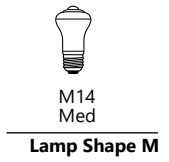
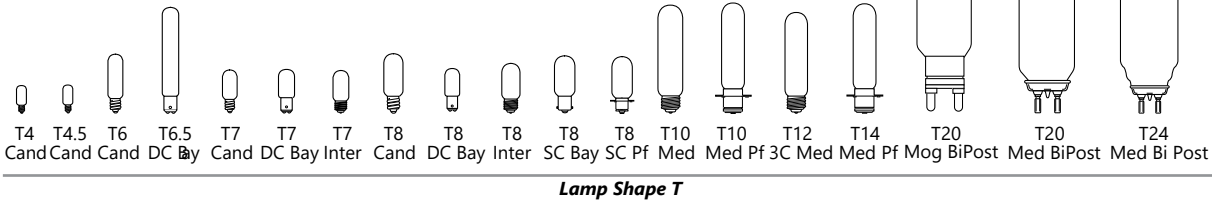
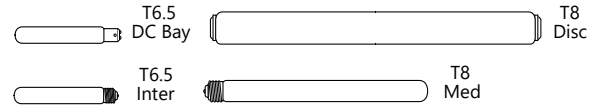
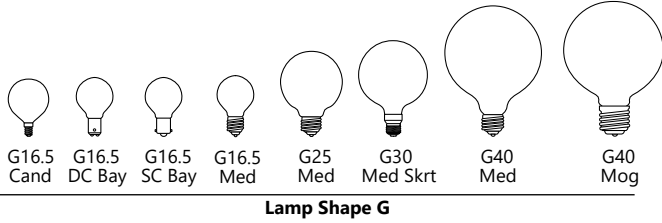
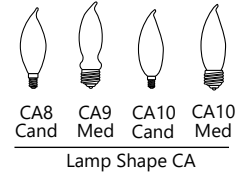
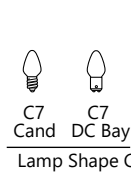
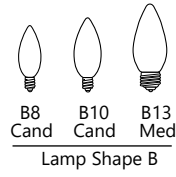
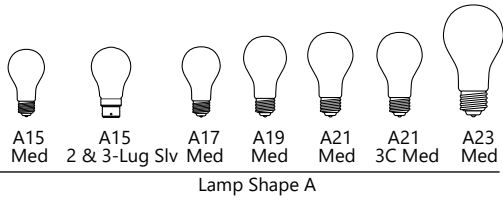



## Catalog Logic:

The following terms and descriptions can help you when checking Incandescent lamp specifications and when ordering products. Within this product line, lamps are listed by wattage.

**Bulb Shape:** followed by its size (the maximum diameter of the bulb expressed in eighths of an inch).

**Watts:** Energy used (as defined by FTC Lamp Label Rules). To estimate energy consumption (kWh), multiply watts x hours of use and divide by 1000.

**Base:** The type of base

**Order Code:** Use the order code when ordering to ensure that you receive the exact product you require.

**Description:** Lamp Model Description

**Filament Design:** Filaments are designated by a letter combination in which C is coiled wire filament, CC is a coiled wire that is itself wound into a larger coil and SR is straight ribbon filament. Numbers represent the type of filament-support arrangement.

**Carton Quantity:** Number of lamps packed in a carton

**Volts:** Lamp data is based on operation at rated voltage

**MOL (in):** Maximum Overall Length in inches

**LCL (in):** Lamp Label Rules is rated life in hours.

**Color Temperature – Kelvins (K):** A measure of the visual "warmth" or "coolness" of the light from the lamp. The higher the value, the warmer or "cooler" the light appears.

**Rated Life (hours):** Life (as defined by FTC Lamp Label Rules) is rated life in hours.

**Initial Lumens:** Lamp light output after the initial 100 hours of operation.

**CBCP (Center beam Candlepower):** For reflector-type lamps, Center Beam Candlepower is the intensity (candelas) at the center of maximum intensity of the beam. Used only for ConstantColor® CMH® Metal Halide Lamps

**Additional Information:** Typical application and/or other important information.

**LED Replacement:** Current offers a wide range of LED replacement lamps. The LED lamp models are provided as general guidance. Often, there will be more than one LED Lamp that may be used to replace a Traditional lamp. For Traditional lamps that operated off a ballast, the ballast bypass (UL Type B) LED option is given unless otherwise noted. The application should be considered when selecting an LED replacement lamp. Sometimes, Traditional lamps do not have a suitable LED replacement due to special application considerations, such as very high heat. Contact Current for additional guidance if the appropriate LED solution is unclear.

Bulb Shape	Base Type	Watts	Order Code	Description	Volts	Car-ton Qty	Filament Design	MOL (In)	LCL (In)	Rated Life (hrs*)	Lumens Initial	Color Temp	CBCP	Additional Information	LED Replacement	
3-8 Watts															Order Code	Description
S6	Cand	3	11098	3S6/5 24PK	130	24	C-7A	1.87	1.37	3,000	11			Clear-Indicator		

## 15A/W-2PK

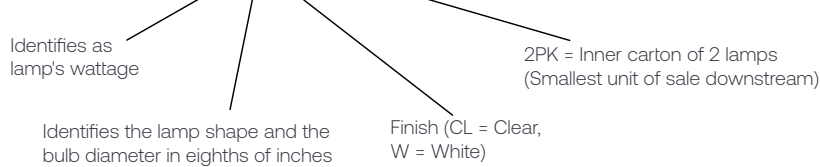

# Incandescent Lamps



## Incandescent Lamps

Incandescent Lamps														LED Replacement		
Bulb Shape	Base Type	Watts	Order Code	Description	Volts	Car-ton Qty <sup>1</sup>	Filament Design	MOL (In)	LCL (In)	Rated Life (hrs*)	Lumens Initial	Color Temp	CBCP	Additional Information	Order Code	Description
<b>3-8 Watts</b>																
S6	Cand	3	11098	3S6/5 24PK	130	24	C-7A	1.87	1.37	3,000	11			Clear-Indicator		
	Cand	6	11374	6S6 155	155	240	C-7A	1.87	1.37	1,500	38			Clear-Indicator		
T4.5	Cand	6	11764	6T4.5/2/1	130	100	C-7A	1.87	1.31	1,500	42			Clear-Indicator		
<b>15 Watts</b>																
A15	Med	15	97491	15A/W-2PK	120	24	C-9	3.50	2.37	2,500	110			Soft-White	93142810	LED4DFA15-W-2PK
S11	DC Bay	15	13188	15S11/3DC	75	120	C-9	2.37	1.25	1,000	138			Clear-Train		
T6	Cand	15	13402	15T6	145	60	C-7A	3.06	1.56	1,500	102			Clear-Exit		
T7	Cand	15	13494	15T7C	120	120	C-7A	2.25	1.50	3,000	108			Clear-Appliance		
<b>18 Watts</b>																
S11	BA15s	18	13655	18S11/ISC	10	120	CC-6	2.37	1.25	2,000	200			Clear-Railway		
<b>20 Watts</b>																
T6.5	DC Bay	20	34241	20T6.5/2DC/F	120	60	C-8	5.56		5,000	90			Frost-Exit Light		
T6.5	Inter	20	34272	20T6.5/2/F	120	60	C-8	5.50		7,000	90			Frost-Exit Light		
<b>25 Watts</b>																
T7	DC Bay	25	14741	25T7DC	120	60	C-7A	2.25	1.31	1,000	195			Clear-Appliance		
T7	Inter	25	14791	25T7N	120	60	C-7A	2.25	1.56	1,000	195			Clear-Appliance		
T10	Med	25	14880	25T10 24PK	120	192	C-8	5.60		1,000	250			Clear-Display Light		
B10	Med	25	22756	25BM CD2	120	60	C-7A	4.62		1,500	170	2500K		Clear, Blunt Tip	93142811	LED4DFBM-C-2PK
CA10	Cand	25	40045	25CAC/L	120	120	CC-2V	4.12		4,000	210	2500K		Clear, Bent Tip	93142792	LED3DFCAC-C-2PK
<b>40 Watts</b>																
A15	Med	40	15206	40A15 CARD 12PK	120	60	C-9	3.50	2.37	1,500	415	2600K		Clear-Oven Light	93142809	LED4DFA15-C-2PK
<b>50 Watts</b>																
A19	Med	50	16201	50A19/RS/SH	75	120	C-9	3.87	2.50	1,000	500			Train/Rough Service		
<b>200 Watts</b>																
A21	Med	200	16069	200A/CL-1 12PK	120	12	CC-8	5.37	4.06	750	3,780	2900K		Crystal	93309226	LED23A21/827
PAR56	Scrw Term	200	20122	200PAR	30	12	CC-8	4.50		350			230,000	Locomotive		
<b>250 Watts</b>																
R40	Med	250	37770	250R40/1 6PK	120	30	C-9	6.56		5,000	2,200			Heat Lamp		
<b>300 Watts</b>																
PS25	Med	300/266	73788	300M/130V-PK6	130/120	6	CC-8	6.93	4.92	750/1,950	6,120/4,650			Clear	93303384	LED/LC/ED17/7SC
PS35	Mog Screw	300	21025	300	130	24	C-9	9.37	7.00	1,000	5,820			Clear	93303384	LED/LC/ED17/7SC
	Mog Screw	300	21079	300/IF	130	24	C-9	9.37	7.00	1,000	5,820			Inside Frost	93303384	LED/LC/ED17/7SC
	Mog Screw	300	20849	300PAR56/WFL	120	12	CC-13	5		2,000	3,840	2750K	11,000	Wide Flood		
<b>350 Watts</b>																
PAR56	Scrw Term	350	19866	350PAR56/SP	75	12	CC-8	4.50		500	6,200			Locomotive		
<b>375 Watts</b>																
R40	Med Skirt	375	21334	375R40/1	115	24	C-9	7.50		5,000	2,700		1,170	Infrared Reflector		

<sup>1</sup> Minimum order quantity = Carton Qty



# Ballasts





## Understanding Fluorescent Ballasts

GE introduced the first fluorescent ballast more than 70 years ago. Today, Current is providing high-frequency electronic GE Lamp ballasts for almost every fluorescent application.

**With our UltraMax® and UltraStart® ballasts, we are bringing you the future in ballast performance.**

Current's UltraMax® instant-start and UltraStart® programmed start electronic ballasts transform the power of light into efficiency and savings from store shelves to the installation site. The foundation of the "Ultra" family of ballasts starts with its high efficiency ratings. High efficiency ballasts are a minimum of 90% efficiency with some ballasts nearly 95% efficient which means the ballast only consumes 5-10% of the total system power. These high efficiency ballasts exceed minimum high efficiency standards as established by almost all energy advocate groups, utility rebate programs and the NEMA Premium® ballast program. The ballasts are marked with the Ultra brand as well as the NEMA Premium® ballast mark. These ballasts have multi-voltage control (MVC), which automatically adjusts to handle voltage from 120V through 277V. That cuts the ballast models you need to stock from 40 down to 13, which can dramatically reduce inventory carrying costs. UltraMax® ballasts have ArcGuard Protection, too, with a UL Type CC Anti-Arc Rating. Plus, they're ultra-lamp-friendly, with a low lamp current crest factor of 1.4 for optimal lamp performance. Both UltraMax® and UltraStart® have anti-striation control for better light quality with no lamp striations (spiraling). And the small, low-profile design of these ballasts makes retrofits effortless at the job site. Also unique to our programmed start UltraStart® ballasts is parallel lamp operation which means that if one lamp fails the others remain on and quick starting times of less than 700 milliseconds which is necessary in avoiding delays with automatic sensors.

## Fluorescent Ballast Types

### *Electronic Instant Start*

The most common fluorescent ballast is the instant start and is used typically in long 3 to 10-hour lamp cycle applications. These ballasts are energy efficient and can deliver 20% to 40% energy savings when installed with energy-efficient lamps in building retrofits. These ballasts deliver >550 open circuit volts when starting lamps and operate lamps at high frequencies which offers flicker-free operation and better lamp efficiencies. The ballasts are significantly quieter than conventional magnetic ballasts and are backed by Current Lighting's system 5-year ballast limited warranty and extended lamp warranties.

### **UltraMax® Professional Series**

A family of high-efficiency T8 instant-start electronic linear fluorescent ballasts designed to optimize T8 lamps for optimal system energy savings. UltraMax® ballasts have a low lamp current crest factor and virtually "read" and adapt to incoming voltage from 108V to 305V. Other features include UL Type CC Anti-Arc Rating and anti-striation control to eliminate lamp striations and spiraling. These ballasts are offered in ballast factors: low wattage (.77), normal light (.87), normal-high (N+) (1.0) and high (>1.15).

### **UltraMax® General Series**

Offered in dedicated or multi-volt (120-277V), these high performance T8 instant-start ballasts also meet minimum efficiency requirements as established with the NEMA Premium® ballast program. These ballasts are offered in ballast factors: low wattage (.77), normal light (.87) and high (>1.15).



### Programmed Instant Start

Programmed Start electronic ballasts have a lamp starting method that preheats lamp filaments before applying an open circuit voltage (OCV) to start the lamp. Use Programmed Start ballasts to ensure long lamp life when turning lamps on and off more than five times in a day or in conjunction with any automatic light control or sensor. This type of starting circuit keeps lamp-end blackening to a minimum and improves lamp life performance, especially in applications where the lamps are frequently switched on and off.

#### UltraStart®

UltraStart® is a family of high-efficiency Programmed Start electronic linear fluorescent ballasts that also exceed NEMA Premium® ballast efficiency requirements but are designed to optimize T8 lamps in frequently switched applications. Instant start ballasts provide 7,000-13,000 starts before 50% lamp failure. UltraStart® provides greater than 100,000 starts before 50% lamp failure. UltraStart® ballasts provide the same energy savings and convenience of instant start ballasts but with the longer lamp life offered a programmed start ballast. These ballasts are offered in ballast factors: programmed start x-low wattage (XL) (.60), low wattage (.71), normal light (.87) and high (>1.15).



### Ballast Date Codes

#### Date Code

Electronic ballast manufacturing date codes are located on the upper right-hand corner of the label. The code lists the month, year and day of manufacture. A typical code is C16-073, where the month is listed as A (January), B (February), C (March) as in this code followed by the year 16 (2016) and the date of manufacture 073 (the 73rd day of 2016).

#### Ballast Life

Electronic ballasts are designed and manufactured to an average life expectancy of 60,000 hours of operation at maximum rated case temperatures. As a rule of thumb, ballast life is doubled for every 10C reduction in ballast case temperature. However there are other variables such as transients, voltage sags and swells, ambient temperature, etc., which affect ballast life as well.

#### Instant Start vs. Rapid Start Sockets

When using programmed start or dimming ballasts in fixtures, sockets must be 2-pin rapid start type. Fixtures with T8 instant start ballasts must use jumpered rapid start sockets or shunted lamp holders (internal to the lamp holder) that bridge the lamp bi-pins together into one contact on each side of the lamp. If retrofitting from a instant start ballast fixture with shunted sockets to a dimming or programmed start ballast, rapid start type sockets must be used to properly start lamps and maintain rated lamp life.

# Linear Fluorescent Ballasts



## 73190 – GE232MAXP-H/ULTRA

### UltraMax® P-Series Instant Start Multi-Voltage High-Efficiency

2 or 1 – F32T8 120 to 277 "H" 1.18 BF UltraMax® P

- T8 Instant Start Ballasts For F17 (2ft), F25 (3ft), F32 (4ft), F40 (5ft) Lamps
- Energy-saving high-efficiency instant-start electronic ballast (>90%)
- Multi-voltage technology handles voltage from 120 to 277V
- UL Type CC Rating provides protection against arcing in electrical devices
- Anti-striation control for better light quality
- UL 55°C Ambient Temperature rating
- Cold temperature -22°F Minimum Starting Temperature

General Characteristics	
Ballast Type	Electronic – High-Efficiency Multivolt Instant Start
Starting Method	Instant Start
Lamp Wiring	Parallel
Line Voltage Regulation(+/-)	10%
Ambient Temperature (MAX)	55°C (131°F)
Case Temperature (MAX)	90°C (194°F)
Ballast Factor	High
Power Factor Correction	Active
Sound Rating	A (20-24 decibels)
Enclosure Type	Metal
Additional Info	Anti-striation control, Auto-restart, Inherently Thermally Protected, UL Class P

Electrical Characteristics	
Supply Current Frequency	50 Hz/60 Hz

Dimensions	
Length (L)	9.5 in (241 mm)
Width (W)	1.3 in (33 mm)
Height (H)	1.0 in (25.4 mm)
Mounting Dimensions	
Mount Length (M)	8.9 in (226 mm)
Mount Width (X or F)	0.87 in (22 mm)
Mount Slots (MS)	0.3 in (8 mm)
Weight	0.7 lbs
Exit Type	Side
Remote Mounting Distance to Lamp (F32T8)	18 ft
Remote Mounting Wire Gauge	18 AWG
Lead Lengths	
Black	25 in (635 mm)
White	25 in (635 mm)
Blue	31 in (787 mm)
Red	37 in (940 mm)

Specifications and lamp wattage											
Lamp	# of Lamps	Line Volts (V)	System Watts (W)	Nom. Line Current (A)	System Ballast Factor	Ballast Efficacy Factor	Power Factor % (>=)	Crest Factor (<=)	THD% (<=)	Min Starting Temp (°F/°C)	
F32T8	2	120	74	0.62	1.19	1.61	99	1.5	10	-22/-30	
	2	277	73	0.26	1.19	1.63	98	1.5	10	-22/-30	
	1	120	47	0.40	1.38	2.94	99	1.5	10	-22/-30	
	1	277	46	0.18	1.38	3.00	96	1.5	20	-22/-30	
F32T8/WM	2	120	70	0.59	1.16	1.66	99	1.5	10	-22/-30	
	2	277	69	0.26	1.16	1.68	98	1.5	10	-22/-30	
	1	120	43	0.37	1.37	3.19	99	1.5	10	-22/-30	
	1	277	43	0.17	1.37	3.19	95	1.5	15	-22/-30	
F28T8	2	120	65	0.55	1.14	1.75	99	1.5	10	-22/-30	
	2	277	64	0.24	1.14	1.78	97	1.5	10	-22/-30	
	1	120	40	0.34	1.34	3.35	99	1.5	10	-22/-30	
	1	277	41	0.16	1.34	3.27	94	1.5	20	-22/-30	
F32T8/25W	2	120	60	0.51	1.16	1.93	99	1.5	10	-22/-30	
	2	277	60	0.22	1.16	1.93	97	1.5	15	-22/-30	
	1	120	38	0.32	1.37	3.60	99	1.5	15	-22/-30	
	1	277	38	0.15	1.37	3.60	94	1.5	20	-22/-30	
F25T8	2	120	62	0.52	1.17	1.87	99	1.5	10	-22/-30	
	2	277	61	0.22	1.17	1.90	97	1.5	15	-22/-30	
	1	120	38	0.32	1.37	3.61	99	1.5	15	-22/-30	
	1	277	38	0.15	1.37	3.61	94	1.5	20	-22/-30	
F17T8	2	120	41	0.36	1.02	2.85	99	1.5	10	-22/-30	
	2	277	41	0.17	1.02	2.85	95	1.5	20	-22/-30	
	1	120	26	0.23	1.21	5.27	99	1.5	15	-22/-30	
	1	277	27	0.12	1.21	5.07	90	1.5	20	-22/-30	
FE15T8	2	120	32	0.29	1.02	3.19	99	1.5	15	-22/-30	
	2	277	33	0.14	1.02	3.09	93	1.5	20	-22/-30	
	1	120	23	0.19	1.21	5.26	98	1.5	15	-22/-30	
	1	277	22	0.10	1.21	5.50	87	1.5	20	-22/-30	
F40T8	1	120	56	0.46	.66	1.18	99	1.5	10	-22/-30	
	1	277	55	0.21	.66	1.20	94	1.5	15	-22/-30	
F25T12	2	120	64	0.54	1.11	1.73	99	1.5	10	0/-18	
	2	277	63	0.24	1.11	1.76	97	1.5	10	0/-18	
	1	120	40	0.35	1.36	3.40	99	1.5	10	0/-18	
	1	277	40	0.16	1.36	3.40	94	1.5	15	0/-18	

### Safety and Performance



# Linear Fluorescent Ballasts



## 72266 – GE232MAXP-N/ULTRA

UltraMax® P-Series Instant Start  
Multi-Voltage High-Efficiency

2 or 1 – F32T8 120 to 277 "N" 87 BF UltraMax® P

- T8 Instant Start Ballasts For F17 (2ft), F25 (3ft), F32 (4ft), F40 (5ft) Lamps
- Energy-saving high-efficiency instant-start electronic ballast (>90%)
- Multi-voltage technology handles voltage from 120 to 277V
- UL Type CC Rating provides protection against arcing in electrical devices
- Anti-striation control for better light quality
- UL 55°C Ambient Temperature rating
- Cold temperature -22°F Minimum Starting Temperature

General Characteristics	
Ballast Type	Electronic – High-Efficiency Multivolt Instant Start
Starting Method	Instant Start
Lamp Wiring	Parallel
Line Voltage Regulation(+/-)	10%
Ambient Temperature (MAX)	55°C (131°F)
Case Temperature (MAX)	70°C (158°F)
Ballast Factor	Normal
Power Factor Correction	Active
Sound Rating	A (20-24 decibels)
Enclosure Type	Metal
Additional Info	Anti-striation control, Auto-restart, Inherently Thermally Protected, UL Class P

Dimensions	
Length (L)	9.5 in (241 mm)
Width (W)	1.3 in (33 mm)
Height (H)	1.0 in (25.4 mm)

Mounting Dimensions	
Mount Length (M)	8.9 in (226 mm)
Mount Width (X or F)	0.87 in (22 mm)
Mount Slots (MS)	0.3 in (8 mm)
Weight	0.7 lbs
Exit Type	Side
Remote Mounting Distance to Lamp (F32T8)	18 ft
Remote Mounting Wire Gauge	18 AWG

Electrical Characteristics	
Supply Current Frequency	50 Hz/60 Hz

Lead Lengths	
Black	25 in (635 mm)
White	25 in (635 mm)
Blue	31 in (787 mm)
Red	37 in (940 mm)

Specifications and lamp wattage										
Lamp	# of Lamps	Line Volts (V)	System Watts (W)	Nom. Line Current (A)	System Ballast Factor	Ballast Efficacy Factor	Power Factor % (>=)	Crest Factor (<=)	THD% (<=)	Min Starting Temp (°F/°C)
F32T8	2	120	54	0.47	.88	1.63	99	1.5	10	-22/-30
	2	277	53	0.20	.88	1.66	98	1.5	10	-22/-30
	1	120	31	0.26	1.08	3.48	99	1.5	10	-22/-30
	1	277	31	0.12	1.08	3.48	96	1.5	10	-22/-30
F32T8/WM	2	120	52	0.44	.87	1.67	99	1.5	10	-22/-30
	2	277	51	0.19	.87	1.71	98	1.5	10	-22/-30
	1	120	29	0.25	1.07	3.69	99	1.5	10	-22/-30
	1	277	29	0.12	1.07	3.69	96	1.5	10	-22/-30
F28T8	2	120	48	0.40	.85	1.77	99	1.5	10	-22/-30
	2	277	47	0.17	.85	1.81	98	1.5	10	-22/-30
	1	120	27	0.24	1.05	3.89	99	1.5	10	-22/-30
	1	277	27	0.11	1.05	3.89	95	1.5	10	-22/-30
F32T8/25W	2	120	44	0.37	.87	1.98	99	1.5	10	-22/-30
	2	277	43	0.16	.87	2.02	98	1.5	10	-22/-30
	1	120	25	0.23	.87	3.48	99	1.5	10	-22/-30
	1	277	25	0.10	.87	3.48	94	1.5	10	-22/-30
F25T8	2	120	44	0.38	.87	1.98	99	1.5	10	-22/-30
	2	277	44	0.16	.87	1.98	98	1.5	10	-22/-30
	1	120	26	0.23	1.09	4.19	99	1.5	10	-22/-30
	1	277	26	0.11	1.09	4.19	94	1.5	10	-22/-30
F17T8	2	120	31	0.27	.88	2.84	99	1.5	10	-22/-30
	2	277	31	0.12	.88	2.84	96	1.5	10	-22/-30
	1	120	19	0.17	1.09	5.74	99	1.5	10	-22/-30
	1	277	19	0.08	1.09	5.74	90	1.5	20	-22/-30
FE15T8	2	120	25	0.21	.91	3.64	99	1.5	10	-22/-30
	2	277	25	0.10	.91	3.64	93	1.5	15	-22/-30
	1	120	16	0.14	.91	5.69	98	1.5	10	-22/-30
	1	277	16	0.07	.91	5.69	88	1.5	15	-22/-30
F25T12	2	120	46	0.39	.93	2.02	99	1.5	10	0/-18
	2	277	46	0.17	.93	2.02	98	1.5	10	0/-18
	1	120	27	0.24	.93	3.44	99	1.5	10	0/-18
	1	277	27	0.11	.93	3.44	95	1.5	10	0/-18

Safety and Performance



# Linear Fluorescent Ballasts



## 72262 – GE232MAXP-L/ULTRA

UltraMax® P-Series Instant Start  
Multi-Voltage High-Efficiency

2 or 1 – F32T8 120 to 277 "L" .77 BF UltraMax® P

- T8 Instant Start Ballasts For F17 (2ft), F25 (3ft), F32 (4ft), F40 (5ft) Lamps
- Energy-saving high-efficiency instant-start electronic ballast (>90%)
- Multi-voltage technology handles voltage from 120 to 277V
- UL Type CC Rating provides protection against arcing in electrical devices
- Anti-striation control for better light quality
- UL 55°C Ambient Temperature rating
- Cold temperature -22°F Minimum Starting Temperature

General Characteristics	
Ballast Type	Electronic – High-Efficiency Multivolt Instant Start
Starting Method	Instant Start
Lamp Wiring	Parallel
Line Voltage Regulation(+/-)	10%
Ambient Temperature (MAX)	55°C (131°F)
Case Temperature (MAX)	70°C (158°F)
Ballast Factor	Low
Power Factor Correction	Active
Sound Rating	A (20-24 decibels)
Enclosure Type	Metal
Additional Info	Anti-striation control, Auto-restart, Inherently Thermally Protected, UL Class P

Electrical Characteristics	
Supply Current Frequency	50 Hz/60 Hz

Dimensions	
Length (L)	9.5 in (241 mm)
Width (W)	1.3 in (33 mm)
Height (H)	1.0 in (25.4 mm)

Mounting Dimensions	
Mount Length (M)	8.9 in (226 mm)
Mount Width (X or F)	0.87 in (22 mm)
Mount Slots (MS)	0.3 in (8 mm)
Weight	0.7 lbs
Exit Type	Side
Remote Mounting Distance to Lamp (F32T8)	18 ft
Remote Mounting Wire Gauge	18 AWG

Lead Lengths	
Black	25 in (635 mm)
White	25 in (635 mm)
Blue	31 in (787 mm)
Red	37 in (940 mm)

Specifications and lamp wattage											
Lamp	# of Lamps	Line Volts (V)	System Watts (W)	Nom. Line Current (A)	System Ballast Factor	Ballast Efficacy Factor	Power Factor % (>=)	Crest Factor (<=)	THD% (<=)	Min Starting Temp (°F/°C)	
F32T8	2	120	48	0.42	.78	1.63	99	1.5	10	-22/-30	
	2	277	48	0.19	.78	1.63	98	1.5	10	-22/-30	
	1	120	30	0.24	.96	3.20	99	1.5	10	-22/-30	
	1	277	30	0.11	.96	3.20	95	1.5	10	-22/-30	
F32T8/WM	2	120	46	0.39	.77	1.67	99	1.5	10	-22/-30	
	2	277	46	0.17	.77	1.67	98	1.5	10	-22/-30	
	1	120	28	0.22	.77	2.75	99	1.5	10	-22/-30	
	1	277	28	0.11	.77	2.75	94	1.5	10	-22/-30	
F28T8	2	120	43	0.36	.77	1.79	99	1.5	10	-22/-30	
	2	277	42	0.16	.77	1.83	97	1.5	10	-22/-30	
	1	120	26	0.21	.77	2.96	99	1.5	10	-22/-30	
	1	277	26	0.10	.77	2.96	94	1.5	10	-22/-30	
F32T8/25W	2	120	39	0.33	.78	2.00	99	1.5	10	-22/-30	
	2	277	39	0.15	.78	2.00	96	1.5	10	-22/-30	
	1	120	22	0.18	.78	3.55	98	1.5	10	-22/-30	
	1	277	22	0.09	.78	3.55	93	1.5	10	-22/-30	
F25T8	2	120	40	0.34	.78	1.95	99	1.5	10	-22/-30	
	2	277	40	0.15	.78	1.95	96	1.5	10	-22/-30	
	1	120	23	0.21	.96	4.17	99	1.5	10	-22/-30	
	1	277	24	0.10	.96	4.00	93	1.5	15	-22/-30	
F17T8	2	120	28	0.24	.79	2.82	99	1.5	10	-22/-30	
	2	277	29	0.11	.79	2.72	94	1.5	10	-22/-30	
	1	120	17	0.18	.98	5.76	99	1.5	10	-22/-30	
	1	277	18	0.08	.98	5.44	90	1.5	10	-22/-30	
FE15T8	2	120	23	0.20	.78	3.39	99	1.5	10	-22/-30	
	2	277	23	0.10	.78	3.39	91	1.5	15	-22/-30	
	1	120	14	0.13	.78	5.57	99	1.5	10	-22/-30	
	1	277	15	0.07	.78	5.20	87	1.5	10	-22/-30	
F25T12	2	120	42	0.35	.80	1.90	99	1.5	10	0/-18	
	2	277	41	0.15	.80	1.95	97	1.5	10	0/-18	
	1	120	24	0.21	.80	3.33	99	1.5	10	0/-18	
	1	277	24	0.10	.80	3.33	95	1.5	10	0/-18	

Safety and Performance



# Linear Fluorescent Ballasts



## 71723 – GE432MAXP-H/ULTRA

UltraMax® P-Series Instant Start

Multi-Voltage High-Efficiency

4 or 3 – F32T8 120 to 277 "H" 1.18 BF UltraMax® P

- T8 Instant Start Ballasts For F17 (2ft), F25 (3ft), F32 (4ft), F40 (5ft) Lamps
- Energy-saving high-efficiency instant-start electronic ballast (>90%)
- Multi-voltage technology handles voltage from 120 to 277V
- UL Type CC Rating provides protection against arcing in electrical devices
- Anti-striation control for better light quality
- UL 55°C Ambient Temperature rating
- Cold temperature -22°F Minimum Starting Temperature

General Characteristics	
Ballast Type	Electronic – High-Efficiency Multivolt Instant Start
Starting Method	Instant Start
Lamp Wiring	Parallel
Line Voltage Regulation(+/-)	10%
Ambient Temperature (MAX)	55°C (131°F)
Case Temperature (MAX)	90°C (194°F)
Ballast Factor	High
Power Factor Correction	Active
Sound Rating	A (20-24 decibels)
Enclosure Type	Metal
Additional Info	Anti-striation control, Auto-restart, Inherently Thermally Protected, UL Class P

Dimensions	
Length (L)	9.5 in (241 mm)
Width (W)	1.7 in (43 mm)
Height (H)	1.18 in (30 mm)

Mounting Dimensions	
Mount Length (M)	8.9 in (226 mm)
Mount Width (X or F)	1.05 in (27 mm)
Mount Slots (MS)	0.3 in (8 mm)
Weight	1.4 lbs
Exit Type	Side
Remote Mounting Distance to Lamp (F32T8)	18 ft
Remote Mounting Wire Gauge	18 AWG

Electrical Characteristics	
Supply Current Frequency	50 Hz/60 Hz

Lead Lengths	
Black	25 in (635 mm)
White	25 in (635 mm)
Blue	31 in (787 mm)
Red	39 in (991 mm)

### Specifications and lamp wattage

Lamp	# of Lamps	Line Volts (V)	System Watts (W)	Nom. Line Current (A)	System Ballast Factor	Ballast Efficacy Factor	Power Factor % (>=)	Crest Factor (<=)	THD% (<=)	Min Starting Temp (°F/°C)
F32T8	4	120	148	1.30	1.18	.80	99	1.4	10	-22/-30
	4	277	146	0.55	1.18	.81	98	1.4	10	-22/-30
	3	120	119	1.07	1.28	1.08	99	1.4	10	-22/-30
	3	277	117	0.46	1.28	1.09	97	1.4	15	-22/-30
F32T8/WM	4	120	139	1.21	1.18	.85	99	1.4	10	50/10
	4	277	136	0.51	1.18	.87	97	1.4	10	50/10
	3	120	113	0.99	1.25	1.11	99	1.4	10	50/10
	3	277	112	0.41	1.25	1.12	97	1.4	16	50/10
F28T8	4	120	127	1.10	1.18	.93	99	1.4	10	50/10
	4	277	125	0.48	1.18	.94	98	1.4	10	50/10
	3	120	105	0.91	1.24	1.18	99	1.4	10	50/10
	3	277	102	0.40	1.24	1.22	97	1.4	16	50/10
F32T8/25W	4	120	120	1.06	1.18	.98	99	1.4	10	60/16
	4	277	116	0.45	1.18	1.02	98	1.4	10	60/16
	3	120	99	0.88	1.24	1.25	99	1.4	10	60/16
	3	277	95	0.38	1.24	1.31	97	1.4	10	60/16
F25T8	4	120	119	0.45	1.16	.97	97	1.4	10	-22/-30
	4	277	121	1.06	1.16	.96	99	1.4	10	-22/-30
	3	120	101	0.87	1.27	1.26	99	1.4	10	-22/-30
	3	277	100	0.38	1.27	1.27	96	1.4	17	-22/-30
F17T8	4	120	79	0.62	1.16	1.47	99	1.4	10	-22/-30
	4	277	78	0.31	1.16	1.49	96	1.4	10	-22/-30
	3	120	62	0.57	1.25	2.02	99	1.4	10	-22/-30
	3	277	62	0.27	1.25	2.02	95	1.4	21	-22/-30
FE15T8	4	120	62	0.54	1.03	1.66	99	1.4	10	0/-18
	4	277	62	0.26	1.03	1.66	95	1.4	20	0/-18
	3	120	51	0.45	1.12	2.20	99	1.4	10	0/-18
	3	277	52	0.22	1.12	2.15	92	1.4	20	0/-18
F40T8	3	120	146	1.27	1.22	.84	99	1.4	10	-22/-30
	3	277	142	0.54	1.22	.86	97	1.4	14	-22/-30
F25T12	4	120	125	1.10	1.11	.89	99	1.4	10	0/-18
	4	277	122	0.47	1.11	.91	97	1.4	14	0/-18
	3	120	101	0.90	1.22	1.21	99	1.4	10	0/-18
	3	277	100	0.39	1.22	1.22	97	1.4	17	0/-18

Safety and Performance



# Linear Fluorescent Ballasts



## 78627 – GE432MAXP-N/ULTRA

### UltraMax® P-Series Instant Start Multi-Voltage High-Efficiency

4 or 3 – F32T8 120 to 277 "L" .87 BF UltraMax® P

- T8 Instant Start Ballasts For F17 (2ft), F25 (3ft), F32 (4ft), F40 (5ft) Lamps
- Energy-saving high-efficiency instant-start electronic ballast (>90%)
- Multi-voltage technology handles voltage from 120 to 277V
- UL Type CC Rating provides protection against arcing in electrical devices
- Anti-striation control for better light quality
- UL 55°C Ambient Temperature rating
- Cold temperature -22°F Minimum Starting Temperature

General Characteristics	
Ballast Type	Electronic – High-Efficiency Multivolt Instant Start
Starting Method	Instant Start
Lamp Wiring	Parallel
Line Voltage Regulation(+/-)	10%
Ambient Temperature (MAX)	55°C (131°F)
Case Temperature (MAX)	70°C (158°F)
Ballast Factor	Normal
Power Factor Correction	Active
Sound Rating	A (20-24 decibels)
Enclosure Type	Metal
Additional Info	Anti-striation control, Auto-restart, Inherently Thermally Protected, UL Class P

Dimensions	
Length (L)	9.5 in (241 mm)
Width (W)	1.3 in (33 mm)
Height (H)	1.0 in (25.4 mm)

Mounting Dimensions	
Mount Length (M)	8.9 in (226 mm)
Mount Width (X or F)	0.87 in (22 mm)
Mount Slots (MS)	0.3 in (8 mm)
Weight	0.9 lbs
Exit Type	Side
Remote Mounting Distance to Lamp (F32T8)	18 ft
Remote Mounting Wire Gauge	18 AWG

Electrical Characteristics	
Supply Current Frequency	50 Hz/60 Hz

Lead Lengths	
Black	25 in (635 mm)
White	25 in (635 mm)
Red & Blue	31 in (787 mm)
Yellow	39 in (991 mm)

Specifications and lamp wattage											
Lamp	# of Lamps	Line Volts (V)	System Watts (W)	Nom. Line Current (A)	System Ballast Factor	Ballast Efficacy Factor	Power Factor % (>=)	Crest Factor (<=)	THD% (<=)	Min Starting Temp (°F/°C)	
F32T8	4	120	110	0.93	.88	.80	99	1.5	10	-22/-30	
	4	277	108	0.4	.88	.81	98	1.5	10	-22/-30	
	3	120	92	0.78	.96	1.04	99	1.5	10	-22/-30	
	3	277	91	0.34	.96	1.05	98	1.5	10	-22/-30	
F32T8/WM	4	120	103	0.87	.88	.85	99	1.5	10	-22/-30	
	4	277	101	0.37	.88	.87	98	1.5	10	-22/-30	
	3	120	85	0.73	.97	1.14	99	1.5	10	-22/-30	
	3	277	84	0.31	.97	1.15	98	1.5	10	-22/-30	
F28T8	4	120	94	0.80	.84	.89	99	1.5	10	-22/-30	
	4	277	92	0.34	.84	.91	98	1.5	10	-22/-30	
	3	120	77	0.66	.93	1.21	99	1.5	10	-22/-30	
	3	277	76	0.29	.93	1.22	98	1.5	10	-22/-30	
F32T8/25W	4	120	87	0.73	.87	1.00	99	1.5	10	-22/-30	
	4	277	87	0.32	.87	1.00	98	1.5	10	-22/-30	
	3	120	72	0.60	.89	1.24	99	1.5	10	-22/-30	
	3	277	71	0.26	.89	1.25	97	1.5	10	-22/-30	
F25T8	4	120	89	0.74	.86	.97	99	1.5	10	-22/-30	
	4	277	88	0.32	.86	.98	98	1.5	10	-22/-30	
	3	120	74	0.62	.97	1.31	99	1.5	10	-22/-30	
	3	277	73	0.27	.97	1.33	97	1.5	10	-22/-30	
F17T8	4	120	61	0.53	.89	1.46	99	1.5	10	-22/-30	
	4	277	61	0.23	.89	1.46	97	1.5	10	-22/-30	
	3	120	51	0.44	.99	1.94	99	1.5	10	-22/-30	
	3	277	51	0.20	.99	1.94	96	1.5	10	-22/-30	
FE15T8	4	120	48	0.42	.77	1.60	99	1.5	10	-22/-30	
	4	277	48	0.19	.77	1.60	96	1.5	10	-22/-30	
	3	120	41	0.35	.85	2.07	99	1.5	10	-22/-30	
	3	277	40	0.17	.85	2.13	94	1.5	10	-22/-30	
F25T12	4	120	91	0.78	.79	.87	99	1.5	10	0/-18	
	4	277	90	0.33	.79	.88	98	1.5	10	0/-18	
	3	120	76	0.65	.87	1.14	99	1.5	10	0/-18	
	3	277	75	0.28	.87	1.16	98	1.5	10	0/-18	

## Safety and Performance



# Linear Fluorescent Ballasts



## 78625 – GE432MAXP-L/ULTRA

UltraMax® P-Series Instant Start  
Multi-Voltage High-Efficiency

4 or 3 – F32T8 120 to 277 "L" .77 BF UltraMax® P

- T8 Instant Start Ballasts For F17 (2ft), F25 (3ft), F32 (4ft), F40 (5ft) Lamps
- Energy-saving high-efficiency instant-start electronic ballast (>90%)
- Multi-voltage technology handles voltage from 120 to 277V
- UL Type CC Rating provides protection against arcing in electrical devices
- Anti-striation control for better light quality
- UL 55°C Ambient Temperature rating
- Cold temperature -22°F Minimum Starting Temperature

General Characteristics	
Ballast Type	Electronic – High-Efficiency Multivolt Instant Start
Starting Method	Instant Start
Lamp Wiring	Parallel
Line Voltage Regulation(+/-)	10%
Ambient Temperature (MAX)	55°C (131°F)
Case Temperature (MAX)	70°C (158°F)
Ballast Factor	Low
Power Factor Correction	Active
Sound Rating	A (20-24 decibels)
Enclosure Type	Metal
Additional Info	Anti-striation control, Auto-restart, Inherently Thermally Protected, UL Class P

Dimensions	
Length (L)	9.5 in (241 mm)
Width (W)	1.3 in (33 mm)
Height (H)	1.0 in (25.4 mm)

Mounting Dimensions	
Mount Length (M)	8.9 in (226 mm)
Mount Width (X or F)	0.87 in (22 mm)
Mount Slots (MS)	0.3 in (8 mm)
Weight	0.9 lbs
Exit Type	Side
Remote Mounting Distance to Lamp (F32T8)	18 ft
Remote Mounting Wire Gauge	18 AWG

Electrical Characteristics	
Supply Current Frequency	50 Hz/60 Hz

Lead Lengths	
Black	25 in (635 mm)
White	25 in (635 mm)
Red & Blue	31 in (787 mm)
Yellow	39 in (991 mm)

Specifications and lamp wattage											
Lamp	# of Lamps	Line Volts (V)	System Watts (W)	Nom. Line Current (A)	System Ballast Factor	Ballast Efficacy Factor	Power Factor % (>=)	Crest Factor (<=)	THD% (<=)	Min Starting Temp (°F/°C)	
F32T8	4	120	98	0.82	.78	.80	99	1.5	10	-22/-30	
	4	277	96	0.35	.78	.81	98	1.5	10	-22/-30	
	3	120	84	0.72	.88	1.05	99	1.5	10	-22/-30	
	3	277	83	0.31	.88	1.06	98	1.5	10	-22/-30	
F32T8/WM	4	120	92	0.79	.76	.83	99	1.5	10	-22/-30	
	4	277	91	0.34	.76	.84	98	1.5	10	-22/-30	
	3	120	77	0.66	.83	1.08	99	1.5	10	-22/-30	
	3	277	76	0.28	.83	1.09	97	1.5	10	-22/-30	
F28T8	4	120	85	0.72	.75	.88	99	1.5	10	-22/-30	
	4	277	84	0.31	.75	.89	98	1.5	10	-22/-30	
	3	120	68	0.59	.81	1.19	99	1.5	10	-22/-30	
	3	277	67	0.26	.81	1.21	97	1.5	10	-22/-30	
F32T8/25W	4	120	78	0.66	.77	.99	99	1.5	10	-22/-30	
	4	277	77	0.29	.77	1.00	98	1.5	10	-22/-30	
	3	120	62	0.52	.81	1.31	99	1.5	10	-22/-30	
	3	277	61	0.22	.81	1.33	97	1.5	10	-22/-30	
F25T8	4	120	80	0.67	.76	.95	99	1.5	10	-22/-30	
	4	277	79	0.29	.76	.96	98	1.5	10	-22/-30	
	3	120	66	0.55	.84	1.27	99	1.5	10	-22/-30	
	3	277	65	0.25	.84	1.29	97	1.5	15	-22/-30	
F17T8	4	120	56	0.47	.79	1.41	99	1.5	10	-22/-30	
	4	277	56	0.21	.79	1.41	96	1.5	10	-22/-30	
	3	120	47	0.40	.86	1.83	99	1.5	10	-22/-30	
	3	277	47	0.18	.86	1.83	95	1.5	15	-22/-30	
FE15T8	4	120	44	0.38	.76	1.73	99	1.5	10	-22/-30	
	4	277	44	0.18	.76	1.73	95	1.5	10	-22/-30	
	3	120	36	0.32	.76	2.11	99	1.5	10	-22/-30	
	3	277	37	0.15	.76	2.05	93	1.5	15	-22/-30	
F25T12	4	120	81	0.69	.76	.94	99	1.5	10	0/-18	
	4	277	81	0.30	.76	.94	98	1.5	10	0/-18	
	3	120	68	0.58	.76	1.12	99	1.5	10	0/-18	
	3	277	67	0.25	.76	1.13	97	1.5	10	0/-18	

Safety and Performance



# Linear Fluorescent Ballasts



## 49767 – GE259MAXP-N/ULTRA

UltraMax® P-Series Instant Start  
Multi-Voltage High-Efficiency

2 or 1 – F96T8 120 to 277 "N" .87 BF UltraMax® P

- T8 Instant Start Ballasts For 46–59W 4ft–8ft Slimline Lamps
- Energy-saving high-efficiency instant-start electronic ballast (>90%)
- Multi-voltage technology handles voltage from 120 to 277V
- Anti-striation control for better light quality
- Cold temperature 0°F Minimum Starting Temperature

General Characteristics	
Ballast Type	Electronic – High-Efficiency Multivolt Instant Start
Starting Method	Instant Start
Lamp Wiring	Parallel
Line Voltage Regulation(+/-)	10%
Ambient Temperature (MAX)	40°C (104°F)
Case Temperature (MAX)	70°C (158°F)
Ballast Factor	Normal
Power Factor Correction	Active
Sound Rating	A (20–24 decibels)
Enclosure Type	Metal
Additional Info	Anti-striation control, Auto-restart, Inherently Thermally Protected, UL Class P

Electrical Characteristics	
Supply Current Frequency	50 Hz/60 Hz

Dimensions	
Length (L)	9.5 in (241 mm)
Width (W)	1.3 in (33 mm)
Height (H)	1.18 in (30 mm)

Mounting Dimensions	
Mount Length (M)	8.9 in (226 mm)
Mount Width (X or F)	0.87 in (22 mm)
Mount Slots (MS)	0.3 in (8 mm)
Weight	1.4 lbs
Exit Type	Side
Remote Mounting Distance to Lamp (F32T8)	18 ft
Remote Mounting Wire Gauge	18 AWG

Lead Lengths	
Black	22 in (559 mm)
White	22 in (559 mm)
Blue	46 in (1168 mm)
Red	78 in (1981 mm)

Specifications and lamp wattage										
Lamp	# of Lamps	Line Volts (V)	System Watts (W)	Nom. Line Current (A)	System Ballast Factor	Ballast Efficacy Factor	Power Factor % (>=)	Crest Factor (<=)	THD% (<=)	Min Starting Temp (°F/°C)
F96T8	2	120	107	0.91	.87	.81	99	1.7	10	0/-18
	2	277	105	0.4	.87	.83	98	1.7	15	0/-18
	1	120	62	0.53	.87	1.40	99	1.7	10	0/-18
	1	277	62	0.24	.87	1.40	97	1.7	20	0/-18
F96T8/WM	2	120	102	0.87	.87	.85	99	1.7	10	50/10
	2	277	100	0.38	.87	.87	98	1.7	15	50/10
	1	120	59	0.5	.87	1.47	99	1.7	10	50/10
	1	277	59	0.23	.87	1.47	97	1.7	20	50/10
F96T8/WMP	2	120	85	0.78	.89	1.05	99	1.7	10	50/10
	2	277	84	0.32	.89	1.06	98	1.7	15	50/10
	1	120	59	0.5	.87	1.47	99	1.7	10	50/10
	1	277	59	0.23	.87	1.47	97	1.7	20	50/10
F72T8	2	120	79	0.72	.89	1.13	99	1.7	10	0/-18
	2	277	78	0.29	.89	1.14	98	1.7	13	0/-18
	1	120	44	0.39	.87	1.98	99	1.7	10	0/-18
	1	277	44	0.17	.87	1.98	96	1.7	20	0/-18

Safety and Performance



UL Class P



UL Type 1 Outdoor



UL Type HL

FCC – CLASS A Non-Consumer

# Linear Fluorescent Ballasts



## 63888 – GE286MAXP-HO-N

UltraMax® P-Series

Multivolt High Output 120V-277V

2 or 1 – F96T8HO IS 120 to 277 "N" .87 BF

- T8 Instant Start Ballasts For 44-86W 4ft-8ft HO Lamps
- High-performance electronic ballast for all general fluorescent applications
- Instant start electronic ballast for long lamp starting cycles and low initial cost
- Multi-voltage technology handles voltage from 120 to 277V
- Parallel lamp operation means system maintenance is easier to manage
- Anti-striation control for better light quality
- Cold temperature -22°F Minimum Starting Temperature

General Characteristics	
Ballast Type	Electronic – Multivolt Instant Start
Starting Method	Instant Start
Lamp Wiring	Parallel
Line Voltage Regulation(+/-)	10%
Ambient Temperature (MAX)	40°C (104°F)
Case Temperature (MAX)	70°C (158°F)
Ballast Factor	Normal
Power Factor Correction	Active
Sound Rating	A (20-24 decibels)
Enclosure Type	Metal
Additional Info	Auto-restart, Inherently Thermally Protected, UL Class P

Dimensions	
Length (L)	9.5 in (241 mm)
Width (W)	1.7 in (43 mm)
Height (H)	1.18 in (30 mm)

Mounting Dimensions	
Mount Length (M)	8.9 in (226 mm)
Mount Width (X or F)	1.05 in (27 mm)
Mount Slots (MS)	0.3 in (8 mm)
Weight	1.40 lbs
Exit Type	Side
Remote Mounting Distance to Lamp (F32T8)	18 ft
Remote Mounting Wire Gauge	18 AWG

Electrical Characteristics	
Supply Current Frequency	50 Hz/60 Hz

Lead Lengths	
Black	22 in (559 mm)
White	22 in (559 mm)
Blue	46 in (1168 mm)
Red	78 in (1981 mm)

Specifications and lamp wattage											
Lamp	# of Lamps	Line Volts (V)	System Watts (W)	Nom. Line Current (A)	System Ballast Factor	Ballast Efficacy Factor	Power Factor % (>=)	Crest Factor (<=)	THD% (<=)	Min Starting Temp (°F/°C)	
F96T849W	2	120	111	0.95	1.37	1.23	99	1.7	10	-22/-30	
	2	277	110	0.41	1.37	1.25	97	1.7	10	-22/-30	
	1	120	70	0.58	1.63	2.33	99	1.7	10	-22/-30	
	1	277	70	0.26	1.63	2.33	95	1.7	10	-22/-30	
F96T8WMP	2	120	124	1.10	1.37	1.10	99	1.7	10	-22/-30	
	2	277	122	0.46	1.37	1.12	98	1.7	10	-22/-30	
	1	120	77	0.68	1.63	2.11	99	1.7	10	-22/-30	
	1	277	77	0.30	1.63	2.11	96	1.7	10	-22/-30	
F96T8WM	2	120	135	1.18	1.14	.85	99	1.7	10	-22/-30	
	2	277	133	0.50	1.15	.86	98	1.7	10	-22/-30	
	1	120	84	0.73	1.35	1.61	99	1.7	10	-22/-30	
	1	277	84	0.32	1.35	1.61	96	1.7	10	-22/-30	
F96T8HO	2	120	145	1.25	.78	.54	99	1.7	10	-22/-30	
	2	277	142	0.54	.78	.55	98	1.7	10	-22/-30	
	1	120	91	0.78	.91	1.01	99	1.7	10	-22/-30	
	1	277	90	0.35	.92	1.02	97	1.7	10	-22/-30	
F96T8	2	120	142	1.24	1.15	.81	99	1.7	10	-22/-30	
	2	277	140	0.52	1.15	.82	98	1.7	10	-22/-30	
	1	120	88	0.76	1.35	1.54	99	1.7	10	-22/-30	
	1	277	87	0.34	1.36	1.56	97	1.7	10	-22/-30	
F72T8HO	2	120	115	1.02	.82	.71	99	1.7	10	-22/-30	
	2	277	114	0.43	.82	.72	97	1.7	16	-22/-30	
	1	120	73	0.64	.95	1.30	99	1.7	10	-22/-30	
	1	277	72	0.28	.95	1.31	95	1.7	22	-22/-30	
F60T8HO	2	120	95	0.84	.81	.86	99	1.7	10	-22/-30	
	2	277	92	0.35	.81	.88	97	1.7	18	-22/-30	
	1	120	60	0.53	.95	1.58	99	1.7	11	-22/-30	
	1	277	62	0.24	.95	1.53	94	1.7	23	-22/-30	
F58T8	2	120	78	0.68	.79	1.01	99	1.7	10	-22/-30	
	2	277	78	0.30	.79	1.01	96	1.7	10	-22/-30	
	1	120	49	0.43	.93	1.91	99	1.7	10	-22/-30	
	1	277	50	0.20	.93	1.87	93	1.7	10	-22/-30	
F48T8HO	2	120	78	0.70	.82	1.05	99	1.7	10	-22/-30	
	2	277	77	0.30	.82	1.06	96	1.7	21	-22/-30	
	1	120	51	0.45	.95	1.87	99	1.7	13	-22/-30	
	1	277	51	0.20	.95	1.87	93	1.7	26	-22/-30	
F40T8	2	120	97	0.85	1.20	1.24	99	1.7	10	-22/-30	
	2	277	96	0.37	1.20	1.25	97	1.7	10	-22/-30	
	1	120	62	0.52	1.39	2.24	99	1.7	10	-22/-30	
	1	277	62	0.24	1.37	2.21	95	1.7	10	-22/-30	

Safety and Performance

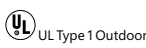

FCC – CLASS A Non-Consumer

# Linear Fluorescent Ballasts



## 74109 – GE232MAXP347-H

UltraMax® P-Series

347V High-Efficiency

2 or 1 – F32T8 347V "H" 1.18 BF UltraMax® P

- T8 Instant Start Ballasts
- Energy-saving high-efficiency instant-start electronic ballast (>90%)
- Instant start ballast for long lamp starting cycles and low initial cost
- Anti-striation control for better light quality
- Cold temperature -22°F Minimum Starting Temperature
- Parallel lamp operation means system maintenance is easier to manage

General Characteristics	
Ballast Type	Electronic – High-Efficiency Instant Start
Starting Method	Instant Start
Lamp Wiring	Parallel
Line Voltage Regulation(+/-)	10%
Ambient Temperature (MAX)	40°C (104°F)
Case Temperature (MAX)	70°C (158°F)
Ballast Factor	High
Power Factor Correction	Active
Sound Rating	A (20-24 decibels)
Enclosure Type	Metal
Additional Info	Anti-striation control, Auto-restart, Inherently Thermally Protected, UL Class P

Electrical Characteristics	
Supply Current Frequency	60 Hz

Dimensions	
Length (L)	9.5 in (241 mm)
Width (W)	1.3 in (33 mm)
Height (H)	1.18 in (30 mm)

Mounting Dimensions	
Mount Length (M)	8.9 in (226 mm)
Mount Width (X or F)	0.87 in (22 mm)
Mount Slots (MS)	0.3 in (8 mm)
Weight	1.04 lbs
Exit Type	Side
Remote Mounting Distance to Lamp (F32T8)	18 ft
Remote Mounting Wire Gauge	18 AWG

Lead Lengths	
Black	25 in (635 mm)
White	25 in (635 mm)
Blue	31 in (787 mm)
Red	45 in (1143 mm)

Specifications and lamp wattage										
Lamp	# of Lamps	Line Volts (V)	System Watts (W)	Nom. Line Current (A)	System Ballast Factor	Ballast Efficacy Factor	Power Factor % (>=)	Crest Factor (<=)	THD% (<=)	Min Starting Temp (°F/°C)
F32T8	2	347	70	0.20	1.18	1.69	99	1.7	10	-22/-30
	1	347	44	0.13	1.32	3.00	99	1.7	10	-22/-30
F32T8/WM	2	347	67	0.19	1.15	1.72	99	1.7	10	60/16
	1	347	42	0.12	1.29	3.07	99	1.7	10	60/16
F28T8	2	347	63	0.12	1.30	2.06	99	1.7	17	60/16
	1	347	39	0.18	1.30	3.33	99	1.7	17	60/16
F32T8/25W	2	347	56	0.16	1.12	2.00	99	1.7	10	60/16
F25T8	2	347	55	0.16	1.16	2.11	99	1.7	10	-22/-30
	1	347	36	0.11	1.32	3.67	99	1.7	30	-22/-30
F25T8/WM	2	347	47	0.14	1.16	2.47	98	1.7	10	60/16
F17TB	2	347	37	0.11	1.10	2.97	97	1.7	12	-22/-30
	1	347	23	0.08	1.25	5.43	87	1.7	52	-22/-30
F17T8/WM	2	347	31	0.10	1.10	3.55	97	1.7	12	60/16
FE15T8	2	347	30	0.09	1.00	3.33	94	1.7	30	-22/-30
	1	347	19	0.07	1.15	6.05	82	1.7	55	-22/-30
F17T8/WM	2	347	53	0.16	1.24	2.34	99	1.7	10	-22/-30
FE15T8	2	347	61	0.18	1.23	2.02	99	1.7	10	-22/-30
	1	347	39	0.12	1.45	3.72	95	1.7	20	-22/-30

### Safety and Performance

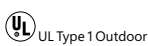

ICES-005 for EMI and RFI FCC – CLASS A Non-Consumer

ANSI - C82.11 - Cons 2002, ANSI - C62.41 - 1991

# Linear Fluorescent Ballasts



## 74093 – GE232MAXP347-N

UltraMax® P-Series

347V High-Efficiency

2 or 1 – F32T8 347V "N" .87 BF UltraMax® P

- T8 Instant Start Ballasts For 46-59W 4ft-8ft Slimline Lamps
- Energy-saving high-efficiency instant-start electronic ballast (>90%)
- Instant start ballast for long lamp starting cycles and low initial cost
- Anti-striation control for better light quality
- Cold temperature 0°F Minimum Starting Temperature
- Parallel lamp operation means system maintenance is easier to manage

General Characteristics	
Ballast Type	Electronic – High-Efficiency Instant Start
Starting Method	Instant Start
Lamp Wiring	Parallel
Line Voltage Regulation(+/-)	10%
Ambient Temperature (MAX)	40°C (104°F)
Case Temperature (MAX)	70°C (158°F)
Ballast Factor	Normal
Power Factor Correction	Active
Sound Rating	A (20-24 decibels)
Enclosure Type	Metal
Additional Info	Anti-striation control, Auto-restart, Inherently Thermally Protected, UL Class P

Dimensions	
Length (L)	9.5 in (241 mm)
Width (W)	1.3 in (33 mm)
Height (H)	1.18 in (30 mm)

Mounting Dimensions	
Mount Length (M)	8.9 in (226 mm)
Mount Width (X or F)	0.87 in (22 mm)
Mount Slots (MS)	0.3 in (8 mm)
Weight	1.04 lbs
Exit Type	Side
Remote Mounting Distance to Lamp (F32T8)	18 ft
Remote Mounting Wire Gauge	18 AWG

Electrical Characteristics	
Supply Current Frequency	60 Hz

Lead Lengths	
Black	25 in (635 mm)
White	25 in (635 mm)
Blue	31 in (787 mm)
Red	45 in (1143 mm)

Specifications and lamp wattage										
Lamp	# of Lamps	Line Volts (V)	System Watts (W)	Nom. Line Current (A)	System Ballast Factor	Ballast Efficacy Factor	Power Factor % (>=)	Crest Factor (<=)	THD% (<=)	Min Starting Temp (°F/°C)
F32T8	2	347	53	0.15	0.87	1.65	99	1.7	10	-22/-30
	1	347	34	0.10	1.02	3.03	97	1.7	10	-22/-30
F32T8/WM	2	347	50	0.15	0.86	1.72	99	1.7	10	60/16
	1	347	32	0.09	1.02	3.20	97	1.7	10	60/16
F28T8	2	347	46	0.14	0.84	1.81	99	1.7	10	60/16
	1	347	30	0.09	1.01	3.38	97	1.7	10	60/16
F32T8/25W	2	347	42	0.12	0.84	2.00	99	1.7	10	60/16
F25T8	2	347	41	0.12	0.88	2.12	98	1.7	10	-22/-30
	1	347	26	0.08	1.03	3.89	90	1.7	25	-22/-30
F25T8/WM	2	347	35	0.11	0.88	2.51	98	1.7	10	60/16
F17TB	2	347	30	0.09	0.83	2.78	96	1.7	10	-22/-30
	1	347	20	0.07	0.98	5.00	80	1.7	50	-22/-30
F17T8/WM	2	347	25	0.08	0.83	3.32	97	1.7	10	60/16
FE15T8	2	347	24	0.08	0.76	3.19	88	1.7	32	-22/-30
	1	347	16	0.06	0.88	5.52	77	1.7	69	-22/-30
F25T12	2	347	44	0.13	0.89	2.03	98	1.7	10	-22/-30
	1	347	29	0.09	1.08	3.76	96	1.7	10	-22/-30

### Safety and Performance



UL Class P



UL Type 1 Outdoor



UL Type HL

ICES-005 for EMI and RFI FCC – CLASS A Non-Consumer

ANSI - C82.11 - Cons 2002, ANSI - C82.41 - 1991

# Linear Fluorescent Ballasts



## 74096 – GE232MAXP347-L

UltraMax® P-Series

347V High-Efficiency

2 or 1 – F32T8 347V "L" .87 BF UltraMax® P

- T8 Instant Start Ballasts
- Energy-saving high-efficiency instant-start electronic ballast (>90%)
- Instant start ballast for long lamp starting cycles and low initial cost
- Anti-striation control for better light quality
- Cold temperature -22°F Minimum Starting Temperature
- Parallel lamp operation means system maintenance is easier to manage

General Characteristics	
Ballast Type	Electronic – High-Efficiency Instant Start
Starting Method	Instant Start
Lamp Wiring	Parallel
Line Voltage Regulation(+/-)	10%
Ambient Temperature (MAX)	40°C (104°F)
Case Temperature (MAX)	70°C (158°F)
Ballast Factor	Low
Power Factor Correction	Active
Sound Rating	A (20-24 decibels)
Enclosure Type	Metal
Additional Info	Anti-striation control, Auto-restart, Inherently Thermally Protected, UL Class P

Dimensions	
Length (L)	9.5 in (241 mm)
Width (W)	1.3 in (33 mm)
Height (H)	1.18 in (30 mm)

Mounting Dimensions	
Mount Length (M)	8.9 in (226 mm)
Mount Width (X or F)	0.87 in (22 mm)
Mount Slots (MS)	0.3 in (8 mm)
Weight	1.04 lbs
Exit Type	Side
Remote Mounting Distance to Lamp (F32T8)	18 ft
Remote Mounting Wire Gauge	18 AWG

Electrical Characteristics	
Supply Current Frequency	60 Hz

Lead Lengths	
Black	25 in (635 mm)
White	25 in (635 mm)
Blue	31 in (787 mm)
Red	45 in (1143 mm)

Specifications and lamp wattage										
Lamp	# of Lamps	Line Volts (V)	System Watts (W)	Nom. Line Current (A)	System Ballast Factor	Ballast Efficacy Factor	Power Factor % (>=)	Crest Factor (<=)	THD% (<=)	Min Starting Temp (°F/°C)
F32T8	2	347	48	0.14	0.77	1.60	99	1.7	10	-22/-30
	1	347	30	0.10	0.90	3.00	87	1.7	37	-22/-30
F32T8/WM	2	347	45	0.13	0.77	1.71	99	1.7	10	60/16
	1	347	29	0.10	0.89	3.07	86	1.7	40	60/16
F28T8	2	347	42	0.12	0.74	1.76	99	1.7	10	60/16
	1	347	27	0.09	0.87	3.22	83	1.7	41	60/16
F32T8/25W	2	347	37	0.12	0.74	2.00	98	1.7	10	60/16
F25T8	2	347	37	0.11	0.78	2.11	97	1.7	15	-22/-30
	1	347	24	0.09	0.91	3.79	77	1.7	50	-22/-30
F25T8/WM	2	347	31	0.10	0.78	2.52	97	1.7	15	60/16
F17TB	2	347	27	0.09	0.70	2.59	84	1.7	50	-22/-30
	1	347	18	0.08	0.86	4.78	68	1.7	53	-22/-30
F17T8/WM	2	347	23	0.08	0.74	3.22	84	1.7	50	60/16
FE15T8	2	347	22	0.08	0.67	3.05	79	1.7	54	-22/-30
	1	347	15	0.06	0.77	5.13	66	1.7	56	-22/-30
F25T12	2	347	39	0.11	0.77	1.97	98	1.7	10	-22/-30
	1	347	25	0.09	0.91	3.64	80	1.7	42	-22/-30

### Safety and Performance



UL Class P



UL Type 1 Outdoor



UL Type HL

ICES-005 for EMI and RFI FCC – CLASS A Non-Consumer

ANSI - C82.11 - Cons 2002, ANSI - C62.41 - 1991

# Linear Fluorescent Ballasts



## 72275 – GE232MAX-G-N (Replaces GE-232-MV-N)

### UltraMax® G-Series Instant Start Multivolt 120V-277V

2 or 1 – F32T8 120 to 277 "N" .87 BF Multivolt UltraMax® G

- For F17 (2ft), F25 (3ft), F32 (4ft), F40 (5ft) Lamps
- High-performance electronic ballast for all general fluorescent applications
- Instant start electronic ballast for long lamp starting cycles and low initial cost
- Multi-voltage technology handles voltage from 120 to 277V
- Parallel lamp operation means system maintenance is easier to manage
- Anti-striation control for better light quality
- Cold temperature -22°F Minimum Starting Temperature

General Characteristics	
Ballast Type	Electronic – Multivolt Instant Start
Starting Method	Instant Start
Lamp Wiring	Parallel
Line Voltage Regulation(+/-)	10%
Ambient Temperature (MAX)	40°C (104°F)
Case Temperature (MAX)	70°C (158°F)
Ballast Factor	Normal
Power Factor Correction	Active
Sound Rating	A (20-24 decibels)
Enclosure Type	Metal
Additional Info	Anti-striation control, Auto-restart, Inherently Thermally Protected, UL Class P

Dimensions	
Length (L)	9.5 in (241 mm)
Width (W)	1.3 in (33 mm)
Height (H)	1.18 in (30 mm)

Mounting Dimensions	
Mount Length (M)	8.9 in (226 mm)
Mount Width (X or F)	0.87 in (22 mm)
Mount Slots (MS)	0.3 in (8 mm)
Weight	1.06 lbs
Exit Type	Side
Remote Mounting Distance to Lamp (F32T8)	18 ft
Remote Mounting Wire Gauge	18 AWG

Electrical Characteristics	
Supply Current Frequency	50 Hz/60 Hz

Lead Lengths	
Black	25 in (635 mm)
White	25 in (635 mm)
Blue	31 in (787 mm)
Red	45 in (1143 mm)

### Specifications and lamp wattage

Lamp	# of Lamps	Line Volts (V)	System Watts (W)	Nom. Line Current (A)	System Ballast Factor	Ballast Efficacy Factor	Power Factor % (>=)	Crest Factor (<=)	THD% (<=)	Min Starting Temp (°F/°C)
F32T8	2	120	57	0.48	.88	1.54	99	1.7	10	-22/-30
	2	277	55	0.2	.88	1.60	98	1.7	10	-22/-30
	1	120	35	0.3	1.08	3.09	99	1.7	10	-22/-30
	1	277	35	0.13	1.08	3.09	97	1.7	10	-22/-30
F32T8/WM	2	120	53	0.44	.86	1.62	99	1.7	10	60/16
	2	277	51	0.19	.87	1.71	97	1.7	10	60/16
	1	120	33	0.28	1.05	3.18	99	1.7	10	60/16
	1	277	33	0.12	1.05	3.18	96	1.7	10	60/16
F28T8	2	120	47	0.39	.83	1.77	99	1.7	10	60/16
	2	277	47	0.17	.83	1.77	97	1.7	10	60/16
	1	120	31	0.26	1.02	3.29	99	1.7	10	60/16
	1	277	31	0.11	.02	.06	95	1.7	10	60/16
F32T8/25W	2	120	43	0.36	.83	1.93	99	1.7	10	60/16
	2	277	43	0.16	.83	1.93	97	1.7	10	60/16
	1	120	28	0.24	1.02	3.64	99	1.7	10	60/16
	1	277	28	0.10	1.02	3.64	98	1.7	10	60/16
F25T8	2	120	44	0.37	.90	2.05	99	1.7	10	-22/-30
	2	277	44	0.16	.91	2.07	97	1.7	10	-22/-30
	1	120	28	0.23	1.08	3.86	99	1.7	10	-22/-30
	1	277	28	0.11	1.08	3.86	95	1.7	10	-22/-30
F17T8	2	120	31	0.26	.88	2.84	99	1.7	10	-22/-30
	2	277	31	0.12	.88	2.84	95	1.7	10	-22/-30
	1	120	20	0.17	1.05	5.25	99	1.7	10	-22/-30
	1	277	21	0.08	1.05	5.00	92	1.7	14	-22/-30
F40T8	1	120	44	0.37	1.08	2.45	99	1.7	10	0/-18
	1	277	43	0.16	1.08	2.51	96	1.7	10	0/-18

### Safety and Performance



UL Class P



UL Type 1 Outdoor



UL Type HL

FCC – CLASS A Non-Consumer

# Linear Fluorescent Ballasts



## 74463 – GE432MAX-G-N (Replaces GE432MV-N)

### UltraMax® G-Series T8

### Multivolt 120V-277V

4 or 3 – F32T8 120 to 277 "N" .87 BF Multivolt UltraMax® G

- For F17 (2ft), F25 (3ft), F32 (4ft), F40 (5ft) Lamps
- High-performance electronic ballast for all general fluorescent applications
- Instant start electronic ballast for long lamp starting cycles and low initial cost
- Multi-voltage technology handles voltage from 120 to 277V
- Parallel lamp operation means system maintenance is easier to manage
- Anti-striation control for better light quality
- Cold temperature -22°F Minimum Starting Temperature

General Characteristics	
Ballast Type	Electronic – Multivolt Instant Start
Starting Method	Instant Start
Lamp Wiring	Parallel
Line Voltage Regulation(+/-)	10%
Ambient Temperature (MAX)	40°C (104°F)
Case Temperature (MAX)	70°C (158°F)
Ballast Factor	Normal
Power Factor Correction	Active
Sound Rating	A (20-24 decibels)
Enclosure Type	Metal
Additional Info	Anti-striation control, Auto-restart, Inherently Thermally Protected, UL Class P

Dimensions	
Length (L)	9.5 in (241 mm)
Width (W)	1.3 in (33 mm)
Height (H)	1.18 in (30 mm)

Mounting Dimensions	
Mount Length (M)	8.9 in (226 mm)
Mount Width (X or F)	0.87 in (22 mm)
Mount Slots (MS)	0.3 in (8 mm)
Weight	1.40 lbs
Exit Type	Side
Remote Mounting Distance to Lamp (F32T8)	18 ft
Remote Mounting Wire Gauge	18 AWG

Electrical Characteristics	
Supply Current Frequency	50 Hz/60 Hz

Lead Lengths	
Black	25 in (635 mm)
White	25 in (635 mm)
Red & Blue	31 in (787 mm)
Yellow	47 in (1194 mm)

Specifications and lamp wattage											
Lamp	# of Lamps	Line Volts (V)	System Watts (W)	Nom. Line Current (A)	System Ballast Factor	Ballast Efficacy Factor	Power Factor % (>=)	Crest Factor (<=)	THD% (<=)	Min Starting Temp (°F/°C)	
F32T8	4	120	113	0.99	.88	.78	99	1.7	10	-22/-30	
	4	277	110	0.43	.88	.80	98	1.7	10	-22/-30	
	3	120	93	0.83	.93	1.00	99	1.7	10	-22/-30	
	3	277	92	0.36	.93	1.01	98	1.7	10	-22/-30	
F32T8/WM	4	120	103	0.90	.83	.81	99	1.7	10	60/16	
	4	277	103	0.40	.83	.81	98	1.7	10	60/16	
	3	120	87	0.77	.91	1.05	99	1.7	10	60/16	
	3	277	86	0.33	.91	1.06	98	1.7	10	60/16	
F28T8	4	120	93	0.83	.82	.88	99	1.7	10	60/16	
	4	277	92	0.36	.82	.89	98	1.7	10	60/16	
	3	120	77	0.68	.85	1.10	99	1.7	10	60/16	
	3	277	77	0.30	.85	1.10	98	1.7	10	60/16	
F32T8/25W	4	120	88	0.74	.80	.91	99	1.7	10	60/16	
	4	277	87	0.32	.80	.92	98	1.7	15	60/16	
	3	120	73	0.61	.85	1.16	99	1.7	10	60/16	
	3	277	73	0.27	.85	1.16	97	1.7	16	60/16	
F25T8	4	120	88	0.77	.87	.99	99	1.7	10	-22/-30	
	4	277	86	0.34	.87	1.01	98	1.7	10	-22/-30	
	3	120	73	0.64	.93	1.27	99	1.7	10	-22/-30	
	3	277	72	0.28	.93	1.29	98	1.7	10	-22/-30	
F17T8	4	120	60	0.53	.87	1.45	99	1.7	10	-22/-30	
	4	277	60	0.23	.87	1.45	97	1.7	10	-22/-30	
	3	120	51	0.45	.91	1.78	99	1.7	10	-22/-30	
	3	277	51	0.20	.91	1.78	97	1.7	10	-22/-30	
F40T8	3	120	112	0.99			99	1.7	10	0/-18	
	3	277	110	0.43			98	1.7	10	0/-18	

## Safety and Performance



UL Class P



UL Type 1 Outdoor



UL Type HL

FCC – CLASS A Non-Consumer

# Linear Fluorescent Ballasts



## 74103 – GE232MAX-G-347 (Replaces GE232-N-347)

### UltraMax® G-Series

### 347V Instant Start High-Efficiency

2 or 1 – F32T8 347V "N" .87 BF UltraMax® G

- T8 Instant Start Ballasts
- High-performance electronic ballast for all general fluorescent applications
- Instant start ballast for long lamp starting cycles and low initial cost
- Light-weight, Slim Profile Mini Can Housing
- Parallel lamp operation means system maintenance is easier to manage
- Cold temperature 0°F Minimum Starting Temperature

General Characteristics	
Ballast Type	Electronic – High-Efficiency Instant Start
Starting Method	Instant Start
Lamp Wiring	Parallel
Line Voltage Regulation(+/-)	10%
Ambient Temperature (MAX)	40°C (104°F)
Case Temperature (MAX)	70°C (158°F)
Ballast Factor	Normal
Power Factor Correction	Active
Sound Rating	A (20-24 decibels)
Enclosure Type	Metal
Additional Info	Auto-restart, Inherently Thermally Protected, UL Class P

Dimensions	
Length (L)	9.5 in (241 mm)
Width (W)	1.3 in (33 mm)
Height (H)	1.18 in (30 mm)

Mounting Dimensions	
Mount Length (M)	8.9 in (226 mm)
Mount Width (X or F)	0.87 in (22 mm)
Mount Slots (MS)	0.3 in (8 mm)
Weight	1.15 bs
Exit Type	Side
Remote Mounting Distance to Lamp (F32T8)	18 ft
Remote Mounting Wire Gauge	18 AWG

Electrical Characteristics	
Supply Current Frequency	60 Hz

Lead Lengths	
Black	25 in (635 mm)
White	25 in (635 mm)
Blue	31 in (787 mm)
Red	45 in (1143 mm)

Specifications and lamp wattage										
Lamp	# of Lamps	Line Volts (V)	System Watts (W)	Nom. Line Current (A)	System Ballast Factor	Ballast Efficacy Factor	Power Factor % (>=)	Crest Factor (<=)	THD% (<=)	Min Starting Temp (°F/°C)
F32T8	2	347	55	0.16	0.87	1.58	99	1.7	10	0/-18
	1	347	34	0.11	1.03	3.03	97	1.7	10	0/-18
F32T8/WM	2	347	52	0.15	0.85	1.63	99	1.7	10	60/16
	1	347	32	0.09	1.01	3.16	97	1.7	10	60/16
F28T8	2	347	48	0.14	0.84	1.75	99	1.7	10	60/16
	1	347	30	0.09	1.00	3.33	96	1.7	10	60/16
F32T8/25W	2	347	44	0.13	0.84	1.91	99	1.7	10	60/16
F25T8	2	347	41	0.12	0.88	2.15	98	1.7	10	0/-18
	1	347	26	0.08	1.04	4.00	95	1.7	11	0/-18
F25T8/WM	2	347	35	0.11	0.88	2.51	98	1.7	10	60/16
F17T8	2	347	29	0.09	0.83	2.86	96	1.7	10	0/-18
	1	347	19	0.07	0.99	5.21	84	1.7	50	0/-18
F17T8/WM	2	347	24	0.08	0.83	3.46	96	1.7	10	60/16
FE15T8	2	347	24	0.08	0.76	3.17	90	1.7	30	0/-18
	1	347	16	0.06	0.89	5.56	78	1.7	66	0/-18
F25T12	2	347	44	0.13	0.88	2.00	98	1.7	10	0/-18
	1	347	28	0.08	1.07	3.82	96	1.7	10	0/-18

## Safety and Performance

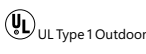

ICES-005 for EMI and RFI

FCC – CLASS A Non-Consumer

ANSI - C82.11 - Cons 2002, ANSI - C62.41 - 1991



# Linear Fluorescent Ballasts

## 74107 – GE432MAX-G-347 (Replaces GE432-N-347)

### UltraMax® G-Series

### 347V Instant Start High-Efficiency

4 or 3 – F32T8 347V "N" .87 BF UltraMax® G

- T8 Instant Start Ballasts
- High-performance electronic ballast for all general fluorescent applications
- Instant start ballast for long lamp starting cycles and low initial cost
- Light-weight, Slim Profile Mini Can Housing
- Parallel lamp operation means system maintenance is easier to manage
- Cold temperature 0°F Minimum Starting Temperature

General Characteristics	
Ballast Type	Electronic – High-Efficiency Instant Start
Starting Method	Instant Start
Lamp Wiring	Parallel
Line Voltage Regulation(+/-)	10%
Ambient Temperature (MAX)	40°C (104°F)
Case Temperature (MAX)	70°C (158°F)
Ballast Factor	Normal
Power Factor Correction	Active
Sound Rating	A (20-24 decibels)
Enclosure Type	Metal
Additional Info	Auto-restart, Inherently Thermally Protected, UL Class P

Electrical Characteristics	
Supply Current Frequency	60 Hz

Dimensions	
Length (L)	9.5 in (241 mm)
Width (W)	1.3 in (33 mm)
Height (H)	1.18 in (30 mm)

Mounting Dimensions	
Mount Length (M)	8.9 in (226 mm)
Mount Width (X or F)	0.87 in (22 mm)
Mount Slots (MS)	0.3 in (8 mm)
Weight	1.15 lbs
Exit Type	Side
Remote Mounting Distance to Lamp (F32T8)	18 ft
Remote Mounting Wire Gauge	18 AWG

Lead Lengths	
Black	25 in (635 mm)
White	25 in (635 mm)
Blue	31 in (787 mm)
Red	47 in (1194 mm)

Specifications and lamp wattage										
Lamp	# of Lamps	Line Volts (V)	System Watts (W)	Nom. Line Current (A)	System Ballast Factor	Ballast Efficacy Factor	Power Factor % (>=)	Crest Factor (<=)	THD% (<=)	Min Starting Temp (°F/°C)
F32T8	4	347	109	0.30	0.88	.81	99	1.7	10	0/-18
	3	347	87	0.25	0.95	1.09	99	1.7	10	0/-18
F32T8/WM	4	347	103	0.29	0.86	.83	99	1.7	10	60/16
	3	347	83	0.24	0.94	1.13	99	1.7	10	60/16
F28T8	4	347	96	0.27	0.84	.88	99	1.7	10	60/16
	3	347	76	0.22	0.92	1.21	99	1.7	10	60/16
F32T8/25W	4	347	87	0.25	0.84	.97	99	1.7	10	60/16
F25T8	4	347	83	0.24	0.88	1.06	99	1.7	10	0/-18
	3	347	68	0.20	0.96	1.41	99	1.7	11	0/-18
F25T8/WM	4	347	71	0.20	0.88	1.24	99	1.7	10	60/16
F17T8	4	347	52	0.17	0.84	1.62	99	1.7	10	0/-18
	3	347	48	0.14	0.91	1.90	98	1.7	50	0/-18
F17T8/WM	4	347	44	0.13	0.84	1.91	99	1.7	10	60/16
FE15T8	4	347	47	0.14	0.76	1.62	98	1.7	30	0/-18
	3	347	38	0.12	0.82	2.16	91	1.7	66	0/-18
F25T12	4	347	87	0.25	0.89	1.02	99	1.7	10	0/-18
	3	347	72	0.21	0.97	1.35	99	1.7	10	0/-18

## Safety and Performance



UL Class P



UL Type 1 Outdoor



UL Type HL

ICES-005 for EMI and RFI

FCC – CLASS A Non-Consumer

ANSI - C82.11 - Cons 2002, ANSI - C62.41 - 1991



## 96714 – GE232-MVPS-N

UltraStart® T8

Programmed Start

2 or 1 – F32T8 120 to 277 Normal Light .88 BF <10% THD UltraStart®

- For F17 (2ft), F25 (3ft), F32 (4ft) Lamps
- < 10% THD, > 99% power factor
- A new generation of ultra-efficient Programmed Start ballasts (> 90% efficiency)
- Anti-striation circuitry reduces striations with energy saving lamps
- Extends lamp life in frequently switched applications (> 100,000 on/off cycles)
- Multi-voltage technology handles voltage from 120 to 277V
- Light-weight, Slim Profile Mini Can Housing

General Characteristics	
Ballast Type	Electronic – Programmed/ Rapid Start
Starting Method	Programmed Start
Lamp Wiring	Parallel
Line Voltage Regulation(+/-)	10%
Ambient Temperature (MAX)	104°C (40°F)
Case Temperature (MAX)	70°C (158°F)
Ballast Factor	Normal
Power Factor Correction	Active
Sound Rating	A (20-24 decibels)
Additional Info	Anti-striation control, Inherently Thermally Protected, UL Class P, Universal voltage

Dimensions	
Length (L)	9.5 in (241 mm)
Width (W)	1.3 in (33 mm)
Height (H)	1.18 in (30 mm)
Mounting Dimensions	
Mount Length (M)	8.9 in (226 mm)
Mount Width (X or F)	1.18 in (30 mm)
Mount Slots (MS)	0.3 in (8 mm)
Weight	1.65 lbs
Exit Type	Side
Remote Mounting Distance to Lamp (F32T8)	18 ft
Remote Mounting Wire Gauge	18 AWG
Lead Lengths	
	<b>Lengths (± 1 in)</b>
Black	25 in (635 mm)
Blue & Red	33 in (838 mm)
White	25 in (635 mm)
Yellow	47 in (1194 mm)

Electrical Characteristics	
Supply Current Frequency	50 Hz/Supply Current Frequency (MIN)/ 50 Hz/ 60 (MIN)
Supply Current Frequency (MIN)	50 Hz/60 Hz

Specifications and lamp wattage										
Lamp	# of Lamps	Line Volts (V)	System Watts (W)	Nom. Line Current (A)	System Ballast Factor	Ballast Efficacy Factor	Power Factor % (>=)	Crest Factor (<=)	THD% (<=)	Min Starting Temp (°F/°C)
F96T8	2	120	59	0.48A	0.89	1.50	99	1.7	10	0/-18
	2	277	58	0.21A	0.89	1.53	96	1.7	10	0/-18
	1	120	37	0.30A	1.05	2.83	98	1.7	10	0/-18
	1	277	37	0.14A	1.05	2.83	93	1.7	10	0/-18
F96T8/WM	2	120	55	0.45A	0.88	1.60	99	1.7	10	50/10
	2	277	54	0.20A	0.88	1.62	96	1.7	10	50/10
	1	120	34	0.28A	1.02	3.00	98	1.7	10	50/10
	1	277	34	0.13A	1.02	3.00	93	1.7	10	50/10
F96T8/WMP	2	120	51	0.42A	0.86	1.68	99	1.7	10	50/10
	2	277	50	0.18A	0.86	1.72	95	1.7	10	50/10
	1	120	32	0.26A	1.00	3.12	98	1.7	10	50/10
	1	277	32	0.12A	1.00	3.12	92	1.7	10	50/10

Safety and Performance

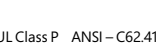

# Linear Fluorescent Ballasts



## 68993 – GE228MVPS-MC (replaces 99655)

### UltraStart® Programmed Start T5 High-Efficiency

2 or 1 – F14-F28T5HE, 120 – 277 UltraStart® PRS Normal Light - .95 BF A Can

- For F14 (2ft), F21 (3ft), F28 (4ft), F35 (5ft) HE T5 Lamps\*
- High Efficiency T5 ballast with Continuous Cathode Cutout Technology
- Lower Maintenance Costs with Parallel Lamp Operation
- Fast Starting Time <700ms
- Multi-Voltage technology means a single ballast handles voltage from 108V to 305V
- Auto-Restart withstands temporary losses in power without the need to cycle power

General Characteristics	
Ballast Type	Electronic – Programmed / Rapid Start
Starting Method	Programmed Start
Lamp Wiring	Parallel
Line Voltage Regulation(+/-)	10%
Ambient Temperature (MAX)	131°F (55°C)
Case Temperature (MAX)	70°C (158°F)
Ballast Factor	Normal
Power Factor Correction	Active
Sound Rating	A (20–24 decibels)
Additional Info	Auto-restart, End-of-Life Protection (EOL), Thermally protected, Universal voltage, Anti-striation control

Dimensions	
Length (L)	9.5 in (241 mm)
Width (W)	1.3 in (33 mm)
Height (H)	1.0 in (25.4 mm)

Mounting Dimensions	
Mount Length (M)	8.9 in (226 mm)
Mount Slots (MS)	0.3 in (8 mm)
Weight	1.0 lbs
Exit Type	Side
Remote Mounting Distance to Lamp	8 ft
Remote Mounting Wire Gauge	18 AWG

Electrical Characteristics	
Supply Current Frequency	50 Hz/60 Hz

Lead Lengths	Length (± 1 in)
White & Black	20 in (508 mm)
Blue & Red	26 in (660 mm)
Yellow	37 in (940 mm)

Specifications and lamp wattage										
Lamp	# of Lamps	Line Volts (V)	System Watts (W)	Nom. Line Current (A)	System Ballast Factor	Ballast Efficacy Factor	Power Factor % (>=)	Crest Factor (<=)	THD% (<=)	Min Starting Temp (°F/°C)
F28T5HE	2	277	60	0.22	.96	1.60	99	1.4	6	0/-18
	1	277	41	0.16	1.21	2.95	97	1.4	9	0/-18
	2	120	62	0.53	.96	1.55	99	1.4	7	0/-18
	1	120	41	0.35	1.21	2.95	99	1.4	8	0/-18
F28T5HL	2	277	60	0.23	.96	1.60	98	1.4	6	32/0
	1	277	41	0.15	1.21	2.95	97	1.4	10	32/0
	2	120	62	0.52	.96	1.55	99	1.4	7	32/0
F28T5WM	1	120	41	0.35	1.21	2.95	99	1.4	8	32/0
	2	277	58	0.22	.98	1.69	98	1.4	6	32/0
F21T5HE	2	120	59	0.50	.98	1.66	99	1.4	7	32/0
	2	277	50	0.18	1.04	2.08	98	1.4	7	32/0
F14T5HE	2	120	51	0.43	1.04	2.04	99	1.4	8	32/0
	2	277	37	0.14	1.10	2.97	97	1.4	10	32/0
F14T5WM	2	120	37	0.32	1.10	2.97	99	1.4	9	32/0
	2	277	36	0.13	1.10	3.06	97	1.4	11	32/0
F14T5WM	2	120	36	0.30	1.10	3.06	99	1.4	9	32/0

## Safety and Performance

UL Type CC 
 UL Type 1 Outdoor 
 UL Listed 
 UL Type HL 
 FCC – CLASS A Non-Consumer 
 UL Class P 
 cUL Listed 
 Meets ANSI Standard C62.41-1991 
 Meets ANSI Standard C82.11- cons 2002. No PCB's

# Linear Fluorescent Ballasts



## 67562 – GE254MVPS90-A

UltraStart® Programmed Start  
T5 High Output

2 or 1 – F54T5HO 120 to 277V UltraStart® PRS High Temp A Can

- For T5 HO Lamps\*
- High Efficiency T5 ballast with Continuous Cathode Cutout Technology
- Lower Maintenance Costs with Parallel Lamp Operation
- Fast Starting Time <700ms
- Multi-Voltage technology means a single ballast handles voltage from 108V to 305V
- Auto-Restart withstands temporary losses in power without the need to cycle power

General Characteristics	
Ballast Type	Electronic – Programmed / Rapid Start
Starting Method	Programmed Start
Lamp Wiring	Parallel
Line Voltage Regulation(+/-)	10%
Ambient Temperature (MAX)	131°F (55°C)
Case Temperature (MAX)	90°C (194°F)
Ballast Factor	Normal
Power Factor Correction	Active
Sound Rating	A (20-24 decibels)
Additional Info	Auto-restart, End-of-Life Protection (EOL), Thermally protected, Universal voltage, Anti-striation control

Dimensions	
Length (L)	9.5 in (241 mm)
Width (W)	1.7 in (43.2 mm)
Height (H)	1.2 in (30.5 mm)
Mounting Dimensions	
Mount Length (M)	8.9 in (226 mm)
Mount Slots (MS)	0.25 in (6 mm)
Weight	1.50 lbs
Exit Type	Side
Remote Mounting Distance to Lamp	12 ft
Remote Mounting Wire Gauge	18 AWG
Lead Lengths	
	<b>Length (± 1 in)</b>
White & Black	25 in (635 mm)
Blue & Red	34 in (864 mm)
Yellow	45 in (1143 mm)

Electrical Characteristics	
Supply Current Frequency	50 Hz/60 Hz

Specifications and lamp wattage											
Lamp	# of Lamps	Line Volts (V)	System Watts (W)	Nom. Line Current (A)	System Ballast Factor	Ballast Efficacy Factor	Power Factor % (>=)	Crest Factor (<=)	THD% (<=)	Min Starting Temp (°F/°C)	
F54T5HO	2	120	117	0.98	1.00	.85	1.00	1.4	4.4	-20/-29	
	2	277	114	0.41	1.10	.96	99	1.4	5.4	-20/-29	
	1	120	63	0.53	1.00	1.59	1.00	1.4	6.4	-20/-29	
	1	277	62	0.23	1.10	1.77	97	1.4	6.6	-20/-29	
F54T5WM	2	120	109	0.90	1.00	.92	1.00	1.4	4.6	0/-18	
	2	277	107	0.40	1.12	1.05	99	1.4	5.2	0/-18	
	1	120	61	0.51	1.00	1.64	1.00	1.4	6.7	0/-18	
F54T5/47W	1	277	60	0.22	1.12	1.87	97	1.4	7.7	0/-18	
	2	120	105	0.88	1.00	.95	1.00	1.4	4.8	-20/-29	
	2	277	104	0.40	1.10	1.06	99	1.4	5.3	-20/-29	
F58T8	1	120	58	0.48	1.00	1.72	1.00	1.4	6.9	-20/-29	
	1	277	57	0.22	1.10	1.93	96	1.4	8.0	-20/-29	
	2	120	110	0.90	.95	.86	1.00	1.4	4.7	-20/-29	
FT55W/4P	2	277	107	0.39	.95	.89	99	1.4	5.4	-20/-29	
	1	120	59	0.49	1.08	1.83	1.00	1.4	6.6	-20/-29	
	1	277	59	0.22	1.08	1.83	96	1.4	7.3	-20/-29	
FT50W/4P	2	120	116	0.97	.86	.74	1.00	1.4	4.9	0/-18	
	2	277	112	0.41	.86	.77	99	1.4	5.4	0/-18	
	1	120	61	0.51	1.03	1.69	1.00	1.4	6.8	0/-18	
FT50W/4P	1	277	60	0.23	1.03	1.72	97	1.4	8.0	0/-18	
	2	120	118	1.00	1.05	.89	1.00	1.4	4.6	0/-18	
	2	277	116	0.43	1.06	.91	99	1.4	5.2	0/-18	
FT50W/4P	1	120	64	0.53	1.18	1.84	1.00	1.4	6.6	0/-18	
	1	277	63	0.24	1.18	1.87	97	1.4	7.4	0/-18	

### Safety and Performance

UL Type 1 Outdoor  
 UL Type CC  
 UL Listed  
 Meets ANSI Standard C62.41-1991  
 UL Class P  
 Meets ANSI Standard C82.11- cons 2002  
 FCC – CLASS A Non-Consumer  
 High Temperature Rated: Suitable for high temperature applications 80°C max case temp 5 yr warranty.

# Linear Fluorescent Ballasts



## 67566 – GE454MVPS90-F (replaces 77114)

### UltraStart® Programmed Start T5 High Output

4-1 – F54T5HO 120 to 277V UltraStart PS F Can

- For T5 HO Lamps\*
- High Efficiency T5 ballast with Continuous Cathode Cutout Technology
- Lower Maintenance Costs with Parallel Lamp Operation
- Fast Starting Time <700ms
- Multi-Voltage technology means a single ballast handles voltage from 108V to 305V
- Auto-Restart withstands temporary losses in power without the need to cycle power
- Anti-Striation Control for better light quality, with no striations
- 90°C case rating/UL Approved 55C Ambient Rating
- Individual lamp End of Lamp Life protection - only one lamp shuts down at end of life
- Cold temperature -20°F Minimum Starting Temperature

General Characteristics	
Ballast Type	Electronic – Programmed / Rapid Start
Starting Method	Programmed Start
Lamp Wiring	Parallel
Line Voltage Regulation(+/-)	10%
Ambient Temperature (MAX)	55°C (131°F)
Case Temperature (MAX)	90°C (194°F)
Ballast Factor	Normal
Power Factor Correction	Active
Sound Rating	A (20-24 decibels)
Enclosure Type	Metal
Additional Info	Auto-restart, End-of-Life Protection (EOL), Thermally protected

Dimensions	
Length (L)	11.75 in (298 mm)
Width (W)	1.7 in (43.2 mm)
Height (H)	1.2 in (30.5 mm)
Mounting Dimensions	
Mount Length (M)	16.7 in (424 mm)
Weight	2.79 lbs
Exit Type	Side
Remote Mounting Distance to Lamp	8 ft
Remote Mounting Wire Gauge	18 AWG
Lead Lengths	
	<b>Length (± 1 in)</b>
Black	25 in (635 mm)
White	25 in (635 mm)

Electrical Characteristics	
Supply Current Frequency	50 Hz/60 Hz

Specifications and lamp wattage										
Lamp	# of Lamps	Line Volts (V)	System Watts (W)	Nom. Line Current (A)	System Ballast Factor	Ballast Efficacy Factor	Power Factor % (>=)	Crest Factor (<=)	THD% (<=)	Min Starting Temp (°F/°C)
FT55W/4P	4	120	206	1.73	.86	.42	99	1.4	5	0/-18
	4	277	203	0.75	.86	.42	97	1.4	8	0/-18
	3	120	168	1.41	.91	.54	99	7.0	6	0/-18
	3	277	168	0.63	.91	.54	97	1.4	10	0/-18
	2	120	125	1.04			99	1.4	7	0/-18
	2	277	124	0.48			94	1.4	16	0/-18
	1	120	64	0.54			99	1.4	10	0/-18
	1	277	66	0.28			84	1.4	25	0/-18
FT50W/4P	4	120	222	1.86	1.06	.48	99	1.4	5	0/-18
	4	277	218	0.81	1.06	.49	98	1.4	8	0/-18
	3	120	187	1.56	1.11	.59	99	1.4	6	0/-18
	3	277	184	0.68	1.11	.60	97	1.4	9	0/-18
	2	120	130	1.09			99	1.4	7	0/-18
	2	277	130	0.50			95	1.4	15	0/-18
	1	120	72	0.60			99	1.4	10	0/-18
	1	277	73	0.31			85	1.4	26	0/-18
F58T8	4	120	208	1.73	.95	.46	99	1.4	5	-20/-29
	4	277	204	0.76	.95	.47	97	1.4	9	-20/-29
	3	120	176	1.47	.99	.56	99	1.4	6	-20/-29
	3	277	173	0.65	.99	.57	94	1.4	10	-20/-29
	2	120	128	1.07			99	1.4	7	-20/-29
	2	277	127	0.49			94	1.4	16	-20/-29
	1	120	67	0.57			99	1.4	10	-20/-29
	1	277	68	0.29			85	1.4	25	-20/-29
F54T5/WM	4	120	214	1.79	1.00	.47	99	1.4	5	0/-18
	4	277	210	0.78	1.00	.48	98	1.4	8	0/-18
	3	120	181	1.51	1.01	.56	99	1.4	6	0/-18
	3	277	178	0.66	1.01	.57	97	1.4	9	0/-18
	2	120	130	1.09	.96	.74	99	1.4	7	0/-18
	2	277	135	0.51	.96	.71	95	1.4	15	0/-18
	1	120	69	0.58	1.12	1.62	99	1.4	10	0/-18
	1	277	70	0.30	1.12	1.60	85	1.4	26	0/-18
F54T5/HO	4	120	220	1.84	1.00	.45	99	1.4	5	-20/-29
	4	277	216	0.80	1.00	.46	98	1.4	8	-20/-29
	3	120	185	1.55	1.01	.55	99	1.4	6	-20/-29
	3	277	182	0.68	1.01	.55	97	1.4	9	-20/-29
	2	120	133	0.58	.96	.72	99	1.4	7	-20/-29
	2	277	132	0.50	.96	.72	95	1.4	15	-20/-29
	1	120	69	0.58	1.11	1.61	99	1.4	10	-20/-29
	1	277	70	0.30	1.11	1.59	85	1.4	26	-20/-29

## Safety and Performance

UL Type 1 Outdoor
 UL Type HL
 UL Type CC
 UL Listed
 CSA
 UL Class P
 UL Type HL
 UL Type CC
 UL Listed
 CSA

ANSI-C82.11-Cons 2002  
 High Temperature Rated: Suitable for high temperature applications 70C max case temp 5 yr warranty or 90C max case temp 3 yr warranty

# Linear Fluorescent Ballasts



## 62731 – GE454PS347-E

### UltraStart® Programmed Rapid Start Ballast T5 High Output

4-1 - F54T5HO 347V UltraStart® LFL E Can

- T5 Electronic Programmed Start
- High Efficiency T5 ballast with Continuous Cathode Cutout Technology
- Lower Maintenance Costs with Parallel Lamp Operation
- Fast Starting Time <700ms
- Auto-Restart withstands temporary losses in power without the need to cycle power
- Anti-Striation Control for better light quality, with no striations.
- 90°C case rating/UL Approved 55°C Ambient Rating
- Individual lamp End of Lamp Life protection - only one lamp shuts down at end of life
- Cold temperature -20°F Minimum Starting Temperature

General Characteristics	
Ballast Type	Electronic – Programmed / Rapid Start
Starting Method	Programmed Rapid Start
Lamp Wiring	Parallel
Line Voltage Regulation(+/-)	10%
Ambient Temperature (MAX)	
Case Temperature (MAX)	70°C (158°F)
Ballast Factor	Normal
Power Factor Correction	Active
Sound Rating	A (20-24 decibels)
Enclosure Type	Metal Can
Additional Info	Lamp End-of-Life Safety Shutdown Circuit/Auto-restart/ Anti-striation control

Electrical Characteristics	
Supply Current Frequency	50 Hz/60 Hz

Dimensions	
Length (L)	16.7 in (424 mm)
Width (W)	1.7 in (43.2 mm)
Height (H)	1.2 in (30.5 mm)
Mounting Dimensions	
Mount Length (M)	16.1 in (409 mm)
Weight	2.5 lbs
Exit Type	Side
Remote Mounting Distance to Lamp	12 ft
Remote Mounting Wire Gauge	18 AWG
Lead Lengths	
	Length (± 1 in)
Black	25 in (635 mm)
White	25 in (635 mm)
Blue	34 in (864 mm)
Blue/White	34 in (864 mm)
Red	34 in (864 mm)
Red/White	34 in (864 mm)
Yellow	35 in (889 mm)

Specifications and lamp wattage										
Lamp	# of Lamps	Line Volts (V)	System Watts (W)	Nom. Line Current (A)	System Ballast Factor	Ballast Efficacy Factor	Power Factor % (>=)	Crest Factor (<=)	THD% (<=)	Min Starting Temp (°F/°C)
F54T5/HO	4	347	229	0.68	1.00	1.75	99	1.4	5	-22/-30
	3	347	176	0.53	1.01	1.70	99	1.4	5	-22/-30
	2	347	125	0.37	.96	1.60	99	1.4	7	-22/-30
	1	347	68	0.21	1.12	1.47	94	1.4	16	-22/-30
FT50W/4P	4	347	227	0.68	1.06	1.76	99	1.4	5	0/-18
	3	347	177	0.53	1.11	1.69	99	1.4	5	0/-18
	2	347	126	0.37		1.59	99	1.4	6	0/-18
	1	347	69	0.22		1.47	94	1.4	16	0/-18
FT55W/4P	4	347	221	0.66	.86	1.81	99	1.4	5	0/-18
	3	347	173	0.51	.91	1.73	99	1.4	5	0/-18
	2	347	123	0.37		1.63	99	1.4	7	0/-18
	1	347	68	0.22		1.47	92	1.4	19	0/-18
F54T5/WM	4	347	219	0.65	1.00	1.83	99	1.4	5	0/-18
	3	347	171	0.51	1.01	1.75	99	1.4	5	0/-18
	2	347	121	0.36	.96	1.65	99	1.4	6	0/-18
	1	347	66	0.21	1.12	1.52	94	1.4	14	0/-18
F58T8	4	347	209	0.62	.95	1.91	99	1.4	5	-22/-30
	3	347	164	0.49	.99	1.83	99	1.4	5	-22/-30
	2	347	117	0.35	.96	1.71	99	1.4	6	-22/-30
	1	347	65	0.20	1.12	1.54	97	1.4	9	-22/-30
F54T5/47W	4	347	206	0.63	1.00	1.94	99	1.4	5	0/-18
	3	347	161	0.48	1.04	1.86	99	1.4	5	0/-18
	2	347	117	0.35	1.06	1.71	99	1.4	6	0/-18
	1	347	65	0.20	1.08	1.54	97	1.4	10	0/-18

## Safety and Performance

UL Type 1 Outdoor 
 UL Type HL 
 FCC – CLASS A Non-Consumer 
 ANSI-C62.41-1991 
 ANSI-C82.11-Cons 2002

ANSI-C62.41-2002 
 UL Class P 
 UL Type CC 
 UL 55C Ambient Approved

High Temperature Rated: Suitable for high temperature applications No PCB's 70C max case temp 5 yr warranty or 90C max case temp 3 yr warranty



## 74119 – GETR480/277-250W

### Step Down Transformers

Non-Isolated Autotransformer 480 to 277V, <250 Watts (VA), A Can

- Precision-wound coils, ensuring even heat dissipation and the highest electrical integrity.
- Non-Isolated Autotransformer designed specifically for lighting applications to step down 480V to 277V
- For use with one or more electronic 277V or universal voltage ballasts within max total system power of autotransformer
- 480Vrms Input, 60Hz Only, 277Vrms Full Load Output or 347Vrms Input
- For loads with total system power <250VA
- Internal Auto Reset Thermal Protector Rated 100C
- For use on single phase or ground referred systems
- Five Year Limited Warranty
- 93% electrical efficiency

General Characteristics	
Ballast Type	Magnetic - Core & Coil
Case Temperature (MAX)	100°C (212°F)
Sound Rating	A (20-24 decibels)
Enclosure Type	Metal
Additional Info	Thermally protected

Electrical Characteristics	
Supply Current Frequency	60 Hz
Supply Current Frequency (MIN)	60 Hz

Specifications by lamp and wattage/Line Volts (V)	
480V to 277V	
347V to 200V	

Dimensions	
Length (L)	9.5 in (241 mm)
Width (W)	1.7 in (43.2 mm)
Height (H)	1.18 in (30 mm)

Mounting Dimensions	
Mount Length (M)	8.9 in (226 mm)
Mount Width (X or F)	1.18 in (30 mm)
Mount Slots (MS)	0.3 in (8 mm)
Exit Type	Side
Remote Mounting Wire Gauge	14 AWG

Lead Lengths	Length (± 1 in)
Black	14.0 in (356 mm)
Blue	14.0 in (356 mm)
Red	14.0 in (356 mm)

### Safety and Performance

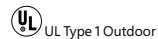

## 74120 – GETR480/277-375W

### Step Down Transformers

Non-Isolated Autotransformer 480 to 277V, <375 Watts (VA), F Can

- Precision-wound coils, ensuring even heat dissipation and the highest electrical integrity.
- Non-Isolated Autotransformer designed specifically for lighting applications to step down 480V to 277V
- For use with one or more electronic 277V or universal voltage ballasts within max total system power of autotransformer
- 480Vrms Input, 60Hz Only, 277Vrms Full Load Output or 347Vrms Input
- For loads with total system power <375VA
- Internal Auto Reset Thermal Protector Rated 100C
- For use on single phase or ground referred systems
- Five Year Limited Warranty
- 93% electrical efficiency

General Characteristics	
Ballast Type	Magnetic - Core & Coil
Case Temperature (MAX)	100°C (212°F)
Sound Rating	A (20-24 decibels)
Enclosure Type	Metal
Additional Info	Thermally protected

Electrical Characteristics	
Supply Current Frequency	60 Hz
Supply Current Frequency (MIN)	60 Hz

Specifications by lamp and wattage/Line Volts (V)	
480V to 277V	
347V to 200V	

Dimensions	
Length (L)	11.75 in (299 mm)
Width (W)	1.7 in (43.2 mm)
Height (H)	1.18 in (30 mm)

Mounting Dimensions	
Mount Length (M)	11.1 in (283 mm)
Mount Slots (MS)	0.3 in (8 mm)
Exit Type	Side
Remote Mounting Wire Gauge	14 AWG

Lead Lengths	Length (± 1 in)
Black	14.0 in (356 mm)
Blue	14.0 in (356 mm)
Red	14.0 in (356 mm)

### Safety and Performance

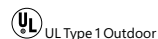

# Linear Fluorescent Ballasts



## 74472 – GE240PS-MV-N (replaces 24107)

ProLine®

T12 Multivolt 120V – 277V

2 or 1 – F40 or F34T12 Rapid Start 120 to 277 "N" BF ProLine® T12

- For F20 (2ft), F30 (3ft), F34/F40 (4ft) T12 Lamps
- High-performance electronic ballast for all general fluorescent applications
- Multi-voltage technology handles voltage from 120 to 277V
- Light weight, low-profile housing
- Parallel lamp operation means system maintenance is easier to manage

General Characteristics	
Ballast Type	Electronic – Programmed / Rapid Start
Starting Method	Rapid Start
Lamp Wiring	Parallel
Line Voltage Regulation(+/-)	10%
Ambient Temperature (MAX)	
Case Temperature (MAX)	70°C (158°F)
Ballast Factor	Normal
Power Factor Correction	Active
Sound Rating	A (20-24 decibels)
Enclosure Type	Metal
Additional Info	Auto-restart, Thermally protected

Dimensions	
Length (L)	9.5 in (241 mm)
Width (W)	1.3 in (33 mm)
Height (H)	1.2 in (30.5 mm)
Mounting Dimensions	
Mount Length (M)	8.9 in (226 mm)
Mount Width (X or F)	1.1 in (28 mm)
Mount Slots (MS)	0.3 in (8 mm)
Weight	1.06 lbs
Exit Type	Side
Remote Mounting Distance to Lamp	18 ft
Remote Mounting Wire Gauge	18 AWG
Lead Lengths	
	Length (± 1 in)
Yellow	48 in (1219 mm)
Blue	33 in (838 mm)
Red	33 in (838 mm)
Black	25 in (635 mm)
White	25 in (635 mm)

Electrical Characteristics	
Supply Current Frequency	60 Hz

Specifications and lamp wattage										
Lamp	# of Lamps	Line Volts (V)	System Watts (W)	Nom. Line Current (A)	System Ballast Factor	Ballast Efficacy Factor	Power Factor % (>=)	Crest Factor (<=)	THD% (<=)	Min Starting Temp (°F/°C)
F40T12	2	120	74	0.67	.89	1.20	99	1.7	6	50/10
	2	277	73	0.30	.89	1.22	97	1.7	10	50/10
	1	120	48	0.41			99	1.7	7	50/10
	1	277	48	0.19			95	1.7	10	50/10
F40T10	2	120	75	0.63	.88	1.17	99	1.7	7	50/10
	2	277	72	0.27	.88	1.22	94	1.7	16	50/10
	1	120	42	0.35			99	1.7	10	50/10
	1	277	42	0.17			88	1.7	16	50/10
F34T12	2	120	63	0.56	.87	1.38	99	1.7	7	50/10
	2	277	62	0.26	.87	1.40	96	1.7	10	50/10
	1	120	41	0.35			99	1.7	8	50/10
	1	277	41	0.17			94	1.7	11	50/10
F30T12/WM	2	120	50	0.42	.95	1.90	99	1.7	9	50/10
	2	277	50	0.20	.95	1.90	91	1.7	18	50/10
	1	120	30	0.26			99	1.7	12	50/10
	1	277	30	0.13			82	1.7	27	50/10
F30T12	2	120	60	0.31	.95	1.58	99	1.7	7	50/10
	2	277	58	0.22	.95	1.64	96	1.7	10	50/10
	1	120	37	0.31			99	1.7	8	50/10
	1	277	37	0.16			94	1.7	11	50/10
F20T12	2	120	46	0.39	1.00	2.17	99	1.7	8	50/10
	2	277	45	0.18	1.00	2.22	94	1.7	11	50/10
	1	120	28	0.24			99	1.7	9	50/10
	1	277	29	0.13			92	1.7	17	50/10

Safety and Performance



FCC Part 18 Class B at 120 volts



# Linear Fluorescent Ballasts



## 74474 – GE-260IS-MV-N (replaces 24108)

ProLine®

T12 Multivolt 120V – 277V

2 or 1 – F96T12 Instant Start 120 to 277

- For T12 4ft – 8ft Slimline Lamps
- High-performance electronic ballast for all general fluorescent applications
- Instant start electronic ballast for long lamp starting cycles and low initial cost
- Multi-voltage technology handles voltage from 120 to 277V
- Light weight, low-profile housing
- Parallel lamp operation means system maintenance is easier to manage

General Characteristics	
Ballast Type	Electronic – Multivolt Instant Start
Starting Method	Rapid Start
Lamp Wiring	Parallel
Line Voltage Regulation(+/-)	10%
Ambient Temperature (MAX)	
Case Temperature (MAX)	70°C (158°F)
Ballast Factor	Normal
Power Factor Correction	Active
Sound Rating	A (20-24 decibels)
Enclosure Type	Metal
Additional Info	Auto-restart, Thermally protected

Dimensions	
Length (L)	9.5 in (241 mm)
Width (W)	1.7 in (43 mm)
Height (H)	1.2 in (30.5 mm)

Mounting Dimensions	
Mount Length (M)	8.9 in (226 mm)
Mount Width (X or F)	1.1 in (28 mm)
Mount Slots (MS)	0.3 in (8 mm)
Weight	2.40 lbs
Exit Type	Side
Remote Mounting Distance to Lamp	18 ft
Remote Mounting Wire Gauge	18 AWG

Lead Lengths	Length (± 1 in)
Black	25 in (635 mm)
White	25 in (635 mm)
Red	59 in (1499 mm)
Blue	67 in (1702 mm)

Electrical Characteristics	
Supply Current Frequency	50Hz/60 Hz

Specifications and lamp wattage										
Lamp	# of Lamps	Line Volts (V)	System Watts (W)	Nom. Line Current (A)	System Ballast Factor	Ballast Efficacy Factor	Power Factor % (>=)	Crest Factor (<=)	THD% (<=)	Min Starting Temp (°F/°C)
F96T12/WMP	2	120	107	0.94	.88	.82	99	1.7	8	60/16
	2	277	106	0.40	.88	.83	96	1.7	10	60/16
	1	120	68	0.60	1.00	1.47	99	1.7	10	60/16
	1	277	68	0.27	1.00	1.47	95	1.7	12	60/16
F96T12/WM	2	120	112	0.98	.90	.80	99	1.7	8	60/16
	2	277	110	0.42	.90	.82	97	1.7	10	60/16
	1	120	72	0.63	1.00	1.39	99	1.7	10	60/16
	1	277	71	0.28	1.00	1.41	95	1.7	12	60/16
F96T12	2	120	141	1.24	.90	.64	99	1.7	8	0/-18
	2	277	138	0.53	.90	.65	98	1.7	10	0/-18
	1	120	90	0.79	1.02	1.13	99	1.7	10	0/-18
	1	277	89	0.34	1.02	1.15	96	1.7	12	0/-18
F84T12	2	120	125	1.10	.90	.72	99	1.7	8	0/-18
	2	277	123	0.47	.90	.73	97	1.7	10	0/-18
	1	120	80	0.70	1.04	1.30	99	1.7	10	0/-18
	1	277	79	0.30	1.04	1.32	96	1.7	12	0/-18
F72T12	2	120	107	0.94	.90	.84	99	1.7	8	0/-18
	2	277	106	0.40	.90	.85	97	1.7	10	0/-18
	1	120	69	0.60	1.08	1.51	99	1.7	10	0/-18
	1	277	69	0.27	1.08	1.51	95	1.7	12	0/-18
F64T12	2	120	97	0.86	.90	.93	99	1.7	8	0/-18
	2	277	96	0.37	.90	.94	97	1.7	10	0/-18
	1	120	63	0.55	1.08	1.71	99	1.7	10	0/-18
	1	277	63	0.25	1.08	1.71	95	1.7	12	0/-18
F60T12	2	120	92	0.81	.90	.98	99	1.7	8	0/-18
	2	277	91	0.35	.90	.99	96	1.7	10	0/-18
	1	120	60	0.53	1.08	1.80	99	1.7	10	0/-18
	1	277	60	0.28	1.08	1.80	94	1.7	12	0/-18
F48T12	2	120	73	0.65	.90	1.23	99	1.7	8	0/-18
	2	277	73	0.29	.90	1.23	95	1.7	10	0/-18
	1	120	49	0.43	1.10	2.24	99	1.7	10	0/-18
	1	277	48	0.20	1.10	2.29	89	1.7	12	0/-18

Safety and Performance

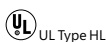
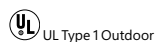

FCC – CLASS A Non-Consumer



cUL Listed



# Linear Fluorescent Ballasts



## 35727 – GE296HO-MVPS-N

ProLine® T12 High Output  
T12 Multivolt 120V – 277V

2 or 1 – F96T12 HO RS 120 to 277 Multivolt ProLine®

General Characteristics	
Ballast Type	Electronic – Programmed/ Rapid Start
Starting Method	Rapid Start
Lamp Wiring	Series
Line Voltage Regulation(+/-)	10%
Ambient Temperature (MAX)	105°F (41°C)
Case Temperature (MAX)	75°C (167°F)
Ballast Factor	Normal
Power Factor Correction	Active
Sound Rating	A (20-24 decibels)
Additional Info	Auto-restart, Thermally protected

Electrical Characteristics	
Supply Current Frequency	50Hz/60 Hz

Dimensions	
Length (L)	11.75 in (299 mm)
Width (W)	2.15 in (55 mm)
Height (H)	1.61 in (41 mm)

Mounting Dimensions	
Mount Length (M)	11.0 in (279 mm)
Mount Width (X or F)	2.15 in (55 mm)
Mount Slots (MS)	
Weight	
Exit Type	Side

### Specifications by lamp and wattage

Lamp	# of Lamps	Line Volts (V)	System Watts (W)	Nom. Line Current (A)	System Ballast Factor	Ballast Efficacy Factor	Power Factor % (>=)	Crest Factor (<=)	THD% (<=)	Min Starting Temp (°F/°C)
F96T12/HO/WM	2	120	164	1.38	.90	.55	99	1.7	10	60/16
	2	277	164	0.62	.90	.55	99	1.7	10	60/16
F96T12/HO	2	120	196	1.65	.90	.47	99	1.7	10	-20/-29
	2	277	196	0.73	.90	.46	97	1.7	10	-20/-29
	1	120	104	0.88	.92	.88	99	1.7	15	-20/-29
F72T12/HO	2	120	154	1.30	.90	.58	99	1.7	10	-20/-29
	2	277	154	0.57	.90	.58	96	1.7	10	-20/-29
	1	120	104	0.42	.92	.88	95	1.7	15	-20/-29
F70T8	2	120	120	1.17	.90	.75	99	1.7	10	-20/-29
	2	277	119	0.52	.90	.76	97	1.7	10	-20/-29
F60T12/HO	2	120	132	0.50	.90	.68	96	1.7	10	-20/-29
	2	277	132	0.50	.90	.68	96	1.7	10	-20/-29
F48T12/HO	2	120	112	0.95	.90	.80	99	1.7	15	-20/-29
	2	277	113	0.43	.90	.80	95	1.7	15	-20/-29

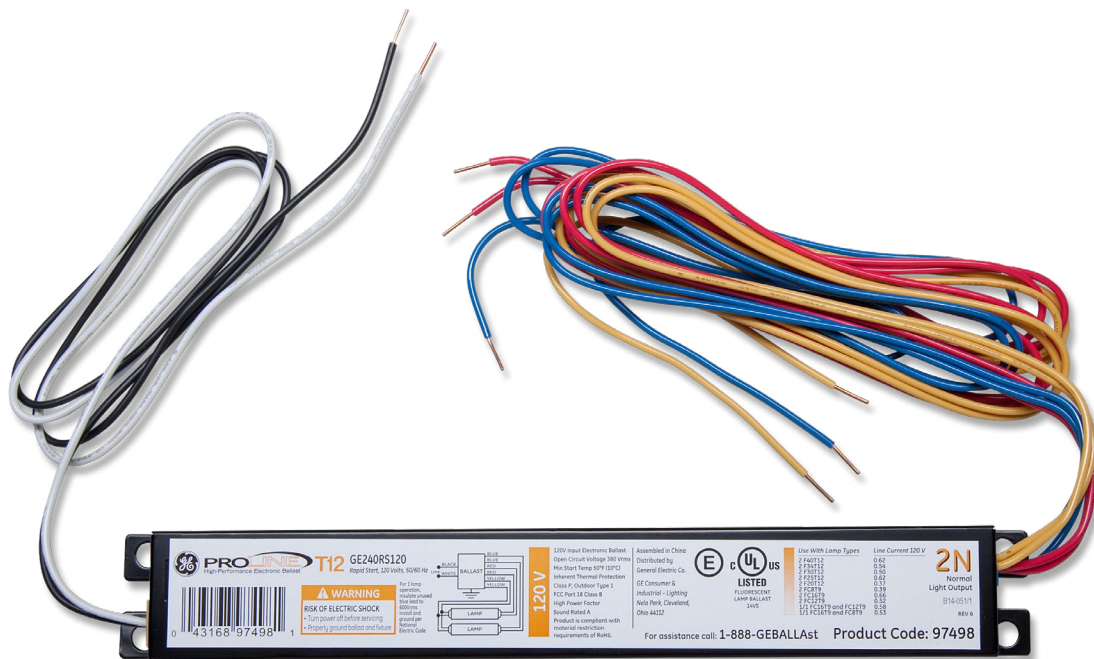

Safety and Performance

cUL Listed UL Listed FCC Part 18 (Class A) Non Consumer

# Compact Fluorescent Ballasts



## Understanding Compact Fluorescent Ballasts

Compact fluorescent (CFL) ballasts provide energy saving alternatives to halogen, incandescent or HID light sources. Multi volt ProLine® CFL programmed start ballasts combine universal voltage (108-305V) technology with multi-lamp capability, dual entry color-coded connectors and ultra system reliability to create an industry leading CFL solution for commercial and residential applications.

UltraMax® and UltraStart® High Lumen Biax® ballasts with the High Lumen WattMiser® Biax® lamp provides the perfect solution for high efficiency and high lumen output in a small space.

### UltraMax® Instant Start Ballasts:

- For use in long burn cycles (>10 hr cycles) to maintain lamp life
- High efficiency (>90%) design
- Universal voltage (120-277V)
- Striation control circuitry
- Small compact housing

### UltraStart® Programmed Start Ballasts:

- For use in shorter burn cycles (<3 hr cycles) to extend lamp life
- High efficiency (>90%) cathode cutout design
- Universal voltage (120-277V)
- Striation control circuitry
- Small compact housing
- Parallel lamp operation
- <700ms fast starting time
- Ballasts available for both F40/30W and F40/25W lamps

### Multivolt ProLine®

Multivolt ProLine® CFL ballasts are offered in 3W configuration: 3-way mounting kits that allow you to have all three mounting options with one kit.

Multivolt ProLine® CFL ballasts come with a five-year ballast and one-year lamp limited warranty. These ballasts have a Consumer Class B EMI rating for residential applications, as well as a high power factor ballast design.

Use the Multivolt ProLine® CFL Multi-Lamp compatibility chart (page 17-3) to find the right ballast for your need.

### ProLine® CFL Date Code System

Date Code Format: 01 200801 = Week2008 = Year

UltraMax® and UltraStart® Biax® ballasts have the same date code system as all linear fluorescent ballasts.



# Compact Fluorescent Ballasts



## 63089 – GEC213-MVPS-3W

### ProLine® CFL Electronic Ballasts

2 or 1 – CFQ13W/G24q 120-227V ProLine® PS

- For 13 – 70W T4 CFL Lamps
- Multi-voltage technology means a single ballast handles voltage from 108V to 305V
- Programmed starting for extended lamp life
- End-of-Lamp-Life protection
- Color coded poke-in connectors simplifies wiring

General Characteristics	
Ballast Type	Electronic – Program/ Rapid Start
Starting Method	Programmed Start
Lamp Wiring	Series
Line Voltage Regulation(+/-)	10%
Ambient Temperature (MAX)	104°F (40°C)
Case Temperature (MAX)	70°C (158°F)
Ballast Factor	Normal
Power Factor Correction	Active
Sound Rating	A (20-24 decibels)
Additional Info	End-of-Life Protection (EOL), Thermally protected, Universal voltage

Dimensions			
Physical Parameters	3W	BES	SE
Length (L)	5.0 in (127 mm)	4.26 in (107 mm)	5.0 in (127 mm)
Width (W)	2.4 in (61 mm)	2.4 in (61 mm)	2.4 in (61 mm)
Height (H)	1.0 in (25 mm)	1.0 in (25 mm)	1.0 in (25 mm)
Mounting Dimensions			
Bracket Length (BL)			
Mount Length (M)	4.63 in (118 mm)		
Mount Width (X or F)	2.4 in (61 mm)		
Mount Slots (MS)			
Weight	0.381 lbs	0.423 lbs	0.395 lbs
Exit Type	Dual Entry (SE/BE, BES, 3W)		
Remote Mounting Distance to Lamp	20ft		
Remote Mounting Wire Gauge	18 AWG		

Electrical Characteristics	
Supply Current Frequency	50Hz/60 Hz

Specifications by lamp and wattage										
Lamp	# of Lamps	Line Volts (V)	System Watts (W)	Nom. Line Current (A)	System Ballast Factor	Ballast Efficacy Factor	Power Factor % (>=)	Crest Factor (<=)	THD% (<=)	Min Starting Temp (°F/°C)
CFQ13W/G24q	2	120	32	0.26	1.04	3.30	99	1.7	10	-20/-29
	2	277	32	0.12	1.04	3.30	96	1.7	10	-20/-29
	1	120	15	0.19	1.09	7.30	99	1.7	10	-20/-29
	1	277	15	0.06	1.09	7.30	89	1.7	18	-20/-29
CFTR13W/GX24q	2	120	32	0.27	1.07	3.30	99	1.7	10	-20/-29
	2	277	32	0.12	1.07	3.30	96	1.7	10	-20/-29
	1	120	16	0.13	1.10	6.90	99	1.7	10	-20/-29
CFS10W/GRI0q	1	277	16	0.07	1.10	6.90	88	1.7	18	-20/-29
	2	120	26	0.22	1.06	4.10	99	1.7	10	-20/-29
	2	277	25	0.10	1.06	4.20	94	1.7	11	-20/-29
CFQ18W/G24q	1	120	13	0.10	1.09	8.40	99	1.7	10	-20/-29
	1	277	13	0.07	1.09	8.40	84	1.7	21	-20/-29
	1	120	19	0.16	.99	5.20	99	1.7	10	-20/-29
CFTR18W/GX24q	1	277	19	0.07	.99	5.20	89	1.7	16	-20/-29
	1	120	19	0.16	.96	5.10	99	1.7	10	-20/-29
CFS16W/GRI0q	1	277	19	0.08	.96	5.10	88	1.7	15	-20/-29
	1	120	17	0.14	1.00	5.90	99	1.7	10	-20/-29
1	277	17	0.07	1.00	5.90	90	1.7	16	-20/-29	

### Safety and Performance

FCC Part 18 Class B UL Class P UL Type 1 Outdoor No PCB's ANSI Standard C82.11-Cons 2002 ANSI Standard C62.41-1991

# Compact Fluorescent Ballasts



## 63093 – GEC218-MVPS-3W

### ProLine® CFL Electronic Ballasts

2 or 1 – CFQ18W/G24q 120-227V ProLine® PS

- For 13 – 70W T4 CFL Lamps
- Multi-voltage technology means a single ballast handles voltage from 108V to 305V
- Programmed starting for extended lamp life
- End-of-Lamp-Life protection
- Color coded poke-in connectors simplifies wiring

General Characteristics	
Ballast Type	Electronic – Program/ Rapid Start
Starting Method	Programmed Start
Lamp Wiring	Series
Line Voltage Regulation(+/-)	10%
Ambient Temperature (MAX)	104°F (40°C)
Case Temperature (MAX)	70°C (158°F)
Ballast Factor	Normal
Power Factor Correction	Active
Sound Rating	A (20-24 decibels)
Additional Info	End-of-Life Protection (EOL), Thermally protected, Universal voltage

Electrical Characteristics	
Supply Current Frequency	50Hz/60 Hz

Dimensions			
Physical Parameters	3W	BES	SE
Length (L)	5.0 in (127 mm)	4.26 in (107 mm)	5.0 in (127 mm)
Width (W)	2.4 in (61 mm)	2.4 in (61 mm)	2.4 in (61 mm)
Height (H)	1.0 in (25 mm)	1.0 in (25 mm)	1.0 in (25 mm)
Mounting Dimensions			
Bracket Length (BL)			
Mount Length (M)	4.63 in (118 mm)		
Mount Width (X or F)	2.4 in (61 mm)		
Mount Slots (MS)			
Weight	0.412 lbs	0.454 lbs	0.426 lbs
Exit Type	Dual Entry (SE/BE, BES, 3W)		
Remote Mounting Distance to Lamp	20 ft		
Remote Mounting Wire Gauge	18 AWG		

#### Specifications by lamp and wattage

Lamp	# of Lamps	Line Volts (V)	System Watts (W)	Nom. Line Current (A)	System Ballast Factor	Ballast Efficacy Factor	Power Factor % (>=)	Crest Factor (<=)	THD% (<=)	Min Starting Temp (°F/°C)
CFQ18W/G24q	2	120	43	0.35	1.05	2.40	99	1.7	10	-20/-29
	2	277	42	0.15	1.05	2.50	96	1.7	10	-20/-29
	1	120	21	0.17	1.08	5.10	99	1.7	10	-20/-29
	1	277	21	0.08	1.08	5.10	88	1.7	15	-20/-29
CFTR18W/GX24q	2	120	44	0.37	1.04	2.40	99	1.7	10	-20/-29
	2	277	43	0.16	1.04	2.40	96	1.7	10	-20/-29
	1	120	22	0.19	1.07	4.90	99	1.7	10	-20/-29
CFS21W/GR10q	1	277	22	0.08	1.07	4.90	87	1.7	14	-20/-29
	2	120	45	0.38	.86	1.90	99	1.7	10	-20/-29
	2	277	44	0.16	.86	2.00	96	1.7	10	-20/-29
CFS16W/GR10q	1	120	22	0.19	.93	4.20	99	1.7	10	-20/-29
	1	277	22	0.09	.93	4.20	88	1.7	15	-20/-29
CFQ26W/GX24q	2	120	39	0.32	1.00	2.60	99	1.7	10	-20/-29
	2	277	38	0.14	1.00	2.60	95	1.7	10	-20/-29
CFTR26W/GX24q	1	120	22	0.19	.91	4.10	99	1.7	10	-20/-29
	1	277	22	0.09	.92	4.20	89	1.7	14	-20/-29
CFS28W/GR10q	1	120	26	0.21	.85	3.30	99	1.7	10	-20/-29
	1	277	26	0.10	.85	3.30	89	1.7	14	-20/-29
CFS28W/GR10q	1	120	25	0.21	.87	3.50	99	1.7	10	-20/-29
	1	277	25	0.10	.87	3.50	91	1.7	13	-20/-29

# Compact Fluorescent Ballasts



## 63097 – GEC226-MVPS-3W

### ProLine® CFL Electronic Ballasts

2 – CFQ26W, FT24 or 1 – 24W CFTR32 120-227V ProLine® PS

- For 13 – 70W T4 CFL Lamps
- Multi-voltage technology means a single ballast handles voltage from 108V to 305V
- Programmed starting for extended lamp life
- End-of-Lamp-Life protection
- Color coded poke-in connectors simplifies wiring

General Characteristics	
Ballast Type	Electronic – Program/ Rapid Start
Starting Method	Programmed Start
Lamp Wiring	Series
Line Voltage Regulation(+/-)	10%
Ambient Temperature (MAX)	104°F (40°C)
Case Temperature (MAX)	75°C (167°F)
Ballast Factor	Normal
Power Factor Correction	Active
Sound Rating	A (20-24 decibels)
Additional Info	Auto restart, Thermally protected, Universal voltage

Dimensions			
Physical Parameters	3W	BES	SE
Length (L)	5.0 in (127 mm)	4.26 in (107 mm)	5.0 in (127 mm)
Width (W)	2.4 in (61 mm)	2.4 in (61 mm)	2.4 in (61 mm)
Height (H)	1.0 in (25 mm)	1.0 in (25 mm)	1.0 in (25 mm)
Mounting Dimensions			
Bracket Length (BL)			
Mount Length (M)	4.63 in (118 mm)		
Mount Width (X or F)	2.4 in (61 mm)		
Mount Slots (MS)			
Weight	0.419 lbs	0.461 lbs	0.434 lbs
Exit Type	Dual Entry (SE/BE, BES, 3W)		
Remote Mounting Distance to Lamp	12 ft		
Remote Mounting Wire Gauge	18 AWG		

Electrical Characteristics	
Supply Current Frequency	50Hz/60 Hz

#### Specifications by lamp and wattage

Lamp	# of Lamps	Line Volts (V)	System Watts (W)	Nom. Line Current (A)	System Ballast Factor	Ballast Efficacy Factor	Power Factor % (>=)	Crest Factor (<=)	THD% (<=)	Min Starting Temp (°F/°C)
CFQ26W/G24q	2	120	56	0.47	1.02	1.82	99	1.7	10	-20/-29
	2	277	54	0.20	1.02	1.89	97	1.7	11	-20/-29
	1	120	30	0.25	1.04	3.47	99	1.7	10	-20/-29
	1	277	30	0.12	1.04	3.47	93	1.7	13	-20/-29
CFTR26W/GX24q	2	120	64	0.53	.97	1.52	99	1.7	10	-20/-29
	2	277	64	0.23	.88	1.38	97	1.7	12	-20/-29
	1	120	32	0.26	1.01	3.16	99	1.7	10	-20/-29
CFS21W/GR10q	1	277	32	0.12	1.00	3.16	94	1.7	13	-20/-29
	2	120	56	0.47	1.12	2.00	99	1.7	10	-20/-29
CFTR42W/GX24q	2	277	55	0.20	1.11	2.02	96	1.7	11	-20/-29
	1	120	51	0.42	.92	1.80	99	1.7	10	-20/-29
CFTR32W/GX24q	1	277	50	0.18	.92	1.84	97	1.7	12	-20/-29
	1	120	39	0.33	1.24	3.18	99	1.7	10	-20/-29
FC16T9 40W	1	277	39	0.15	1.23	3.15	95	1.7	13	-20/-29
	1	120	40	0.33	.89	2.23	99	1.7	10	-20/-29
FT24W/2Gt1	1	277	40	0.14	.94	2.35	95	1.7	13	-20/-29
	1	120	27	0.23	1.04	3.85	99	1.7	10	-20/-29
FT36W/2Gt1	1	277	27	0.11	1.10	4.07	91	1.7	14	-20/-29
	1	120	35	0.29	.94	2.69	99	1.7	10	-20/-29
FT39W/2Gt1	1	277	35	0.13	.94	2.69	94	1.7	13	-20/-29
	1	120	33	0.27	.97	2.94	99	1.7	10	-20/-29
FT39W/2Gt1	1	277	33	0.12	.98	2.97	94	1.7	14	-20/-29

#### Safety and Performance

FCC Part 18 Class B UL Class P UL Type 1 Outdoor No PCB's ANSI Standard C82.11-Cons 2002 ANSI Standard C62.41-1991

# Compact Fluorescent Ballasts



## 63100 – GEC242-MVPS-3W

### ProLine® CFL Electronic Ballasts

2 – 42/36/32/28/26/24 watt 120-227V ProLine® PS

- For 13 – 70W T4 CFL Lamps
- Electronic compact fluorescent ballasts for all general fluorescent applications
- Low-profile case

General Characteristics	
Ballast Type	Electronic – Program/ Rapid Start
Starting Method	Programmed Start
Lamp Wiring	Series
Line Voltage Regulation(+/-)	10%
Ambient Temperature (MAX)	122°F (50°C)
Case Temperature (MAX)	75°C (167°F)
Ballast Factor	Normal
Power Factor Correction	Active
Sound Rating	A (20-24 decibels)
Additional Info	Auto restart, Thermally protected, Universal voltage

Dimensions	
Length (L)	5.0 in (127 mm)
Width (W)	3.0 in (76 mm)
Height (H)	1.38 in (35 mm)
Mounting Dimensions	
Bracket Length (BL)	4.63 in (118 mm)
Mount Length (M)	
Mount Width (X or F)	
Mount Slots (MS)	
Weight	0.90 lbs
Exit Type	Dual Entry (SE/BE, BES, 3W)

Electrical Characteristics	
Supply Current Frequency	50Hz/60 Hz

#### Specifications by lamp and wattage

Lamp	# of Lamps	Line Volts (V)	System Watts (W)	Nom. Line Current (A)	System Ballast Factor	Ballast Efficacy Factor	Power Factor % (>=)	Crest Factor (<=)	THD% (<=)	Min Starting Temp (°F/°C)
CFTR42W/GX24q	2	120	94	0.77	1.00	1.14	99	1.7	10	0/-18
	2	277	93	0.38	1.00	1.08	98	1.7	10	0/-18
	1	120	47	0.40	1.00	2.13	99	1.7	10	0/-18
	1	277	47	0.18	1.00	2.13	96	1.7	10	0/-18
CFTR32W/GX24q	2	120	63	0.53	.95	1.51	99	1.7	10	0/-18
	2	277	63	0.23	.95	1.51	98	1.7	12	0/-18
	1	120	42	0.35	.96	2.29	99	1.7	10	0/-18
CFTR32W/GX24q	1	277	42	0.13	.96	2.29	96	1.7	12	0/-18
	2	120	54	0.45	.90	1.67	99	1.7	10	0/-18
	2	277	54	0.21	.90	1.67	97	1.7	12	0/-18
CFQ26W/G24q, CFTR26W/GX24q	1	120	32	0.27	1.00	3.12	99	1.7	10	0/-18
	1	277	32	0.13	1.00	3.12	95	1.7	12	0/-18
	2	120	63	0.52	.78	1.25	99	1.7	10	0/-18
CFTR42W/GX24q	2	277	62	0.23	.79	1.27	98	1.7	10	0/-18
	1	120	33	0.27	.80	2.45	99	1.7	10	0/-18
	1	277	33	0.13	.80	2.44	94	1.7	15	0/-18
CFTR32W/GX24q	2	120	82	0.69	.95	1.16	99	1.7	10	0/-18
	2	277	82	0.30	.95	1.16	98	1.7	10	0/-18
	1	120	45	0.37	1.00	2.22	99	1.7	10	0/-18
CFTR32W/GX24q	1	277	45	0.17	1.00	2.22	96	1.7	12	0/-18
	2	120	70	0.59	.80	1.13	99	1.7	10	0/-18
	2	277	70	0.26	.81	1.15	98	1.7	10	0/-18
CFTR42W/GX24q	1	120	37	0.31	.84	2.24	99	1.7	10	0/-18
	1	277	37	0.14	.84	2.24	95	1.7	15	0/-18
	2	120	52	0.44	1.10	2.11	99	1.7	10	0/-18
CFTR32W/GX24q	2	277	52	0.19	1.10	2.11	97	1.7	12	0/-18
	1	120	28	0.23	1.10	3.97	99	1.7	10	0/-18
	1	277	28	0.11	1.11	3.92	93	1.7	12	0/-18
CFS16W/GR10q	1	120	58	0.49	1.00	1.72	99	1.7	10	0/-18
	1	277	58	0.22	1.00	1.72	97	1.7	12	0/-18
CFQ26W/GX24q	1	120	73	0.61	1.00	1.37	99	1.7	10	0/-18
	1	277	73	0.27	1.00	1.37	97	1.7	12	0/-18
CFTR26W/GX24q	1	120	43	0.36	.71	1.65	99	1.7	10	0/-18
	1	277	44	0.16	.72	1.66	96	1.7	12	0/-18

#### Safety and Performance

FCC Part 18 Class B at 120 volts



UL Class P



UL Listed



cUL

# Compact Fluorescent Ballasts



## 63100 – GEC242-MVPS-3W (Cont.)

ProLine® CFL Electronic Ballasts

2 – 42/36/32/28/26/24 watt 120-227V ProLine® PS

Specifications by lamp and wattage										
Lamp	# of Lamps	Line Volts (V)	System Watts (W)	Nom. Line Current (A)	System Ballast Factor	Ballast Efficacy Factor	Power Factor % (≥)	Crest Factor (≤)	THD% (≤)	Min Starting Temp (°F/°C)
FT40W/2G11	2	120	82	0.69	.95	1.16	99	1.7	10	0/-18
	2	277	82	0.30	.95	1.16	98	1.7	10	0/-18
	1	120	45	0.37	1.00	2.22	99	1.7	10	0/-18
	1	277	45	0.17	1.00	2.22	96	1.7	12	0/-18
FT36W/2G11	2	120	63	0.52	.78	1.25	99	1.7	10	0/-18
	2	277	62	0.23	.79	1.27	98	1.7	10	0/-18
	1	120	33	0.27	.80	2.45	99	1.7	10	0/-18
	1	277	33	0.13	.80	2.44	94	1.7	15	0/-18
FT24W/2G11	2	120	54	0.45	1.00	1.85	99	1.7	10	0/-18
	2	277	54	0.20	1.00	1.85	97	1.7	12	0/-18
	1	120	26	0.22	.92	3.56	99	1.7	10	0/-18
	1	277	27	0.10	.92	3.48	92	1.7	15	0/-18
CFS28W/GR10q	2	120	60	0.50	.95	1.60	99	1.7	10	0/-18
	2	277	60	0.22	.97	1.62	98	1.7	10	0/-18
	1	120	34	0.29	1.00	2.94	99	1.7	10	0/-18
	1	277	34	0.14	1.00	2.94	93	1.7	15	0/-18
FC9T5+FC12T5	1+1	120	67	0.55	.90	1.34	99	1.7	10	0/-18
	1+1	277	67	0.25	.90	1.34	98	1.7	10	0/-18
CFS55W/GRY10q-3	1	120	33	0.28	.49	1.48	99	1.7	10	0/-18
	1	277	32	0.13	.49	1.53	94	1.7	10	0/-18

Safety and Performance

FCC Part 18 Class B at 120 volts



UL Class P



UL Listed



cUL

# Compact Fluorescent Ballasts



## 71435 – GEC240MAX-A

### High-Lumen Biax® UltraMax® Instant Start

2 or 1 – FT40W-25W/2G11 Biax - 120-277V UltraMax® Instant Start

- Electronic compact fluorescent ballasts for all general fluorescent applications
- Low-profile case
- Multi-Voltage technology handles voltage from 120 to 277V
- Energy saving, high efficiency instant start electronic ballast (> 90%)
- Instant start electronic ballast for long lamp starting cycles and low initial cost
- Anti-Striation Control for better light quality, with no striations
- Lamp End-of-Life Safety Shutdown Circuit with Re-Lamping Auto-reset

General Characteristics	
Ballast Type	Electronic – High Efficiency Instant Start
Starting Method	Instant Start
Lamp Wiring	Parallel
Line Voltage Regulation(+/-)	10%
Ambient Temperature (MAX)	105°F (41°C)
Case Temperature (MAX)	70°C (158°F)
Ballast Factor	Normal
Power Factor Correction	Active
Sound Rating	A (20-24 decibels)
Additional Info	End-of-Life Protection (EOL), Thermally protected

Dimensions	
Length (L)	9.5 in (241 mm)
Width (W)	1.7 in (43 mm)
Height (H)	1.18 in (30 mm)

Mounting Dimensions	
Mount Length (M)	8.9 in (226 mm)
Mount Width (X or F)	1.18 in (30 mm)
Mount Slots (MS)	0.3 in (8 mm)
Weight	1.40 lbs
Exit Type	Side
Remote Mounting Distance to Lamp	12 ft
Remote Mounting Wire Gauge	18 AWG

Lead Lengths	Length (± 1 in)
Blue	31 in (787 mm)
Red	31 in (787 mm)
White	25 in (635 mm)
Black	25 in (635 mm)

Electrical Characteristics	
Supply Current Frequency	50Hz/60 Hz

Specifications by lamp and wattage									
Lamp	# of Lamps	Line Volts (V)	System Watts (W)	Nom. Line Current (A)	System Ballast Factor	Power Factor % (>=)	Crest Factor (<=)	THD% (<=)	Min Starting Temp (°F/°C)
FT40W/4P	2	120	69	0.58	.90	99	1.7	10	0/-18
	2	277	68	0.25	.90	95	1.7	10	0/-18
	1	120	42	0.35	1.00	99	1.7	10	0/-18
	1	277	42	0.16	1.00	95	1.7	15	0/-18
FT40W/28W/4P	2	120	63	0.54	1.00	99	1.7	10	0/-18
	2	277	62	0.23	1.00	95	1.7	10	0/-18
	1	120	38	0.32	1.11	99	1.7	10	0/-18
	1	277	38	0.14	1.11	95	1.7	15	0/-18
FT40W/25W/4P	2	120	58	0.50	1.00	99	1.7	10	0/-18
	2	277	57	0.21	1.00	90	1.7	10	0/-18
	1	120	35	0.29	1.15	99	1.7	10	0/-18
	1	277	35	0.13	1.15	95	1.7	15	0/-18
F32T8	2	120	63	0.54	.94	99	1.7	10	0/-18
	2	277	62	0.23	.94	95	1.7	10	0/-18
	1	120	38	0.32	1.08	99	1.7	10	0/-18
	1	277	38	0.14	1.08	95	1.7	15	0/-18
F28T5/HE	2	120	69	0.59	1.10	99	1.7	10	0/-18
	2	277	68	0.25	1.10	95	1.7	10	0/-18
	1	120	41	0.35	1.26	99	1.7	10	0/-18
	1	277	41	0.15	1.26	95	1.7	15	0/-18

Safety and Performance



UL Type 1 Outdoor



UL Type HL

FCC – CLASS A Non-Consumer



UL Class P



CSA



UL Listed

# Compact Fluorescent Ballasts



## 71436 – GEC340MAX-A

### High-Lumen Biax® UltraMax® Instant Start

3 – FT40W-25W/2G11 Biax - 120-277V UltraMax® Instant Start

- Electronic compact fluorescent ballasts for all general fluorescent applications
- Low-profile case
- Multi-Voltage technology handles voltage from 120 to 277V
- Energy saving, high efficiency instant start electronic ballast (> 90%)
- Instant start electronic ballast for long lamp starting cycles and low initial cost
- Anti-Striation Control for better light quality, with no striations
- Lamp End-of-Life Safety Shutdown Circuit with Re-Lamping Auto-reset

General Characteristics	
Ballast Type	Electronic – High Efficiency Instant Start
Starting Method	Instant Start
Lamp Wiring	Parallel
Line Voltage Regulation(+/-)	10%
Ambient Temperature (MAX)	105°F (41°C)
Case Temperature (MAX)	70°C (158°F)
Ballast Factor	Normal
Power Factor Correction	Active
Sound Rating	A (20-24 decibels)
Additional Info	End-of-Life Protection (EOL), Thermally protected

Dimensions	
Length (L)	9.5 in (241 mm)
Width (W)	1.7 in (43 mm)
Height (H)	1.18 in (30 mm)

Mounting Dimensions	
Mount Length (M)	8.9 in (226 mm)
Mount Width (X or F)	1.18 in (30 mm)
Mount Slots (MS)	0.3 in (8 mm)
Weight	1.40 lbs
Exit Type	Side
Remote Mounting Distance to Lamp	12 ft
Remote Mounting Wire Gauge	18 AWG

Lead Lengths	Length (± 1 in)
Blue	31 in (787 mm)
Red	31 in (787 mm)
White	25 in (635 mm)
Black	25 in (635 mm)

Electrical Characteristics	
Supply Current Frequency	50Hz/60 Hz

#### Specifications by lamp and wattage

Lamp	# of Lamps	Line Volts (V)	System Watts (W)	Nom. Line Current (A)	System Ballast Factor	Power Factor % (>=)	Crest Factor (<=)	THD% (<=)	Min Starting Temp (°F/°C)
FT40W/4P	3	120	100	0.86	.90	99	1.7	10	0/-18
	3	277	99	0.36	.90	99	1.7	10	0/-18
	2	120	76	0.65	.98	99	1.7	10	0/-18
	2	277	75	0.27	.98	95	1.7	10	0/-18
FT40W/28W/4P	3	120	93	0.79	1.00	99	1.7	10	0/-18
	3	277	91	0.33	1.00	95	1.7	10	0/-18
	2	120	70	0.59	1.07	99	1.7	10	0/-18
	2	277	69	0.25	1.07	95	1.7	10	0/-18
FT40W/25W/4P	3	120	85	0.73	1.00	99	1.7	10	0/-18
	3	277	84	0.31	1.00	95	1.7	10	0/-18
	2	120	64	0.53	1.11	99	1.7	10	0/-18
	2	277	63	0.23	1.11	95	1.7	10	0/-18
F32T8	3	120	92	0.78	.94	99	1.7	10	0/-18
	3	277	90	0.33	.94	95	1.7	10	0/-18
	2	120	69	0.59	1.03	99	1.7	10	0/-18
	2	277	68	0.25	1.03	95	1.7	10	0/-18
F28T5/HE	3	120	102	0.87	1.10	99	1.7	10	0/-18
	3	277	100	0.37	1.10	99	1.7	10	0/-18
	2	120	76	0.66	1.19	99	1.7	10	0/-18
	2	277	75	0.28	1.19	95	1.7	10	0/-18

Safety and Performance



UL Type 1 Outdoor



UL Type HL

FCC – CLASS A Non-Consumer



UL Class P



CSA



UL Listed

## Understanding Electromagnetic HID Ballasts

Current offers High Intensity Discharge (HID) ballasts for mercury, probe start metal halide, pulse start metal halide and high pressure sodium lamps. Standard metal halide lamps or probe start metal halide over 150 watts, like fluorescent, are electric discharge lamps and require an open circuit voltage of nearly two times the operating voltage to initiate the arc between the two electrodes in the arc tube. High pressure sodium, pulse start metal halide and probe start metal halide lamps 150 watts or less require an ignitor to initiate the high voltage to start the lamps. The ballasts provide the starting voltage with the igniter, where required and provides stability for the lamp. HID lamps have negative impedance characteristics and would draw current until destruction unless a ballast was in place to regulate the current.

HID lamps take several minutes to warm-up and reach full light output. If power is interrupted between the lamp and the ballast, the arc will extinguish and lamp will go out. The lamp must cool down and reduce the vapor pressure before it will re-start. Typical warm-up and restrike times are as follows:

## HID Ballast Types

### Core and Coil

The most common HID ballasts are the core and coil and is used in 90% of the fixture applications. Core and coil ballasts consist of one, two or three copper (or aluminum) coils on a core of electrical-grade steel laminations. HID ballasts are classified by the kind of circuit they use: Reactor (R), High Reactance autotransformer (HX), Constant Wattage Autotransformer (CWA), Regulated lag (Reg Lag) or Electronic. HID ballast are also classified as high power factor (HPF) or normal power factor (NPF).

HID ballast 150 watts or less have High Reactance Autotransformer circuits and high power factor (HX-HPF). HID ballast greater that 150 watts have Constant Wattage Auto transformer circuits and are high power factor (HPF).

CWA ballast is the most common circuit for core and coil ballast. CWA circuits provide for stable light regulation. The CWA circuit consists of a high reactance autotransformer with a capacitor in series with the lamp resulting with high power factor ballast. In most CWA ballast circuits a 10% drop in line voltage will only reduce the light output and wattage by 5%. The CWA circuit ballast requires an igniter for QMH pulse start, ceramic metal halide and HPS lamps. Igniters are also required for QMH lamps 150 watts or less.





## 86675 – GEM100MLTLC3D-5

### Metal Halide

1 – 100W MH M90 or M140 Quad (120/208/240/277V)

- For 20 – 175W Metal Halide HID Lamps
- Magnetic ballast construction ideal for a wide variety of lighting applications
- Precision-wound coils, ensuring even heat dissipation and the highest electrical integrity
- Distributor replacement kit contains the appropriate core and coil with color coded leads, a properly rated capacitor and igniter (if required) and all other components required for ballast replacement

General Characteristics		Dimensions	
Ballast Type	Magnetic – Core and Coil	Length (L)	5.25 in (133 mm)
ANSI Lamp Codes	M92, M90, M140	Width (W)	1.25 in (32 mm)
Voltage	120/208/240/277	<b>Mounting Dimensions</b>	
Line Voltage Regulation(+/-)	5%	Mount Length (M)	4.6 in (117 mm)
Circuit Type	HX-HPF	Mount Width (X or F)	
Insulation Class	180° C	Mount Slots (MS)	0.25 in (6 mm)
Type of Capacitor	Dry Film	A	2.0
Capacitance	12 Mfd GECAP-12/280V-D	B	3.0
Voltage (MIN)	280	Weight	5.0 lbs
Capacitor Temperature Rating	100°C (212°F)	Exit Type	Side
GE Igniter	MH350-1A	Nominal Length	2.7 in (69 mm)
Sound Rating		Frame Size (H x L)	2.813 in x 3.939 in
Additional Info			
Electrical Characteristics			
Supply Current Frequency	60 Hz		

Specifications by lamp and line voltage											
Lamp	Specifications by line voltage				Lamp	Specifications by line voltage					
		120	208	240	277		120	208	240	277	
M92	System Wattage (W)	119	119	119	119	M90, M140 100W Ceramic Metal Halide 100W Quartz Metal Halide	System Wattage (W)	119	119	119	119
	Nominal Current	1.10A	0.60A	0.50A	0.50A		Nominal Current	1.10A	0.60A	0.50A	0.50A
	Ballast Factor	1	1	1	1		Ballast Factor	1	1	1	1
	Ballast Efficiency Factor						Ballast Efficiency Factor	0.84	0.84	0.84	0.84
	Max Input Current	2.27A	1.30A	1.13A	0.98A		Max Input Current	2.27A	1.30A	1.13A	0.98A
	Starting Current	1.26A	0.69A	0.60A	0.53A		Starting Current	1.26A	0.69A	0.60A	0.53A
	Open Circuit Voltage	274V	274V	274V	274V		Open Circuit Voltage	274V	274V	274V	274V
	Drop Out Voltage	96V	166V	192V	222V		Drop Out Voltage	96V	166V	192V	222V
	Power Factor (>=) %	90	90	90	90		Power Factor (>=) %	90	90	90	90
	Min. Starting Temp (°F/°C)	-22/-30	-22/-30	-22/-30	-22/-30		Min. Starting Temp (°F/°C)	-22/-30	-22/-30	-22/-30	-22/-30
	Fuse Rating	5	4	3	3		Fuse Rating	5	4	3	3
	UL Bench Top Rise	D	D	D	D		UL Bench Top Rise	D	D	D	D



## 86718 – GEM150MLTLC3D-5

### Metal Halide

1 – 150W MH M102 or M142 Quad (120/208/240/277V)

General Characteristics	
Ballast Type	Magnetic – Core and Coil
ANSI Lamp Codes	M142, M102
Voltage	120/208/240/277
Line Voltage Regulation(+/-)	5%
Circuit Type	HX-HPF
Insulation Class	180° C
Type of Capacitor	Dry Film
Capacitance	16 Mfd GECAP-16/280V-D
Voltage (MIN)	300
Capacitor Temperature Rating	100°C (212°F)
GE Igniter	MH350-1A

Electrical Characteristics	
Supply Current Frequency	60 Hz

Specifications by lamp and line voltage						
Lamp	Specifications by line voltage					
	120	208	240	277		
M142, M102 150W Ceramic Metal Halide	System Wattage (W)	186	186	186	186	
	Nominal Current	1.60A	1.00A	0.80A	0.70A	
	Ballast Factor	1	1	1	1	
	Ballast Efficiency Factor	0.81	0.81	0.81	0.81	
	Max Input Current	3.37A	1.95A	1.68A	1.39A	
	Starting Current	1.86A	1.03A	0.89A	0.77A	
	Open Circuit Voltage	257V	257V	257V	257V	
	Drop Out Voltage	96V	166V	192V	222V	
	Power Factor (>=) %	90	90	90	90	
	Min. Starting Temp (°F/°C)	-22/-30	-22/-30	-22/-30	-22/-30	
Metal Halide 150W Quartz Metal Halide	Fuse Rating	10	5	5	4	
	UL Bench Top Rise	A	B	A	A	

- For 20 – 175W Metal Halide HID Lamps
- Magnetic ballast construction ideal for a wide variety of lighting applications
- Precision-wound coils, ensuring even heat dissipation and the highest electrical integrity
- Distributor replacement kit contains the appropriate core and coil with color coded leads, a properly rated capacitor and ignitor (if required) and all other components required for ballast replacement
- Quad ballast (120, 208, 240, 277)

Dimensions	
Length (L)	5.25 in (133 mm)
Width (W)	1.25 in (32 mm)
Mounting Dimensions	
Mount Length (M)	4.6 in (117 mm)
Mount Width (X or F)	
Mount Slots (MS)	0.25 in (6 mm)
A	2.3
B	4.0
Weight	7.0 lbs
Exit Type	Side
Nominal Length	2.7 in (69 mm)
Frame Size (H x L)	2.813 in x 3.939 in

### Safety and Performance

cUL Listed UL Listed

## 63078 – GEM175ML5AA3-5

### Metal Halide

1 – 175W MH M57 or M109 5-Tap (120/208/240/277/480V)

General Characteristics	
Ballast Type	Magnetic – Core and Coil
ANSI Lamp Codes	M57, H38, M109
Voltage	120/208/240/277/480
Line Voltage Regulation(+/-)	10%
Circuit Type	CWA
Insulation Class	180° C
Type of Capacitor	Oil filled
Capacitance	10 Mfd
Voltage (MIN)	400
Capacitor Temperature Rating	100°C (212°F)

Electrical Characteristics	
Supply Current Frequency	60 Hz

Specifications by lamp and line voltage						
Lamp	Specifications by line voltage					
	120	208	240	277	480	
M57, M109	System Wattage (W)	202	202	202	202	202
	Nominal Current	1.70A	1.00A	0.90A	0.80A	0.40A
	Ballast Factor	1	1	1	1	1
	Ballast Efficiency Factor	0.87	0.87	0.87	0.87	0.87
	Max Input Current	1.70A	1.00A	0.90A	0.80A	0.40A
	Starting Current	0.60A	0.37A	0.32A	0.28A	0.21A
	Open Circuit Voltage	307V	307V	307V	307V	307V
	Drop Out Voltage	96V	166V	192V	222V	384V
	Power Factor (>=) %	90	90	90	90	90
	Min. Starting Temp (°F/°C)	-22/-30	-22/-30	-22/-30	-22/-30	-22/-30
Fuse Rating	5	3	3	2	1.5	
UL Bench Top Rise	D	C	C	C	C	

For 20 – 175W Metal Halide HID Lamps

- Magnetic ballast construction ideal for a wide variety of lighting applications
- Precision-wound coils, ensuring even heat dissipation and the highest electrical integrity
- 5-tap ballast (120, 208, 240, 277, or 480 volt) featuring a 480-volt tap

Dimensions	
Length (L)	5.3 in (133 mm)
Width (W)	1.3 in (33 mm)
Mounting Dimensions	
Mount Length (M)	4.6 in (117 mm)
Mount Width (X or F)	
Mount Slots (MS)	0.3 in (8 mm)
A	3.0
B	4.0
Weight	8.0 lbs
Exit Type	Side
Nominal Length	3.2 in (83 mm)
Frame Size (H x L)	2.813 in x 3.939 in

### Safety and Performance

cUL Listed UL Listed



## 87211 – GEM250ML5AC3-5

### Metal Halide

1 – 250W MH M58 5-Tap (120/208/240/277/480V)

- For 250 – 1500W Metal Halide HID Lamps
- Magnetic ballast construction ideal for a wide variety of lighting applications
- Precision-wound coils, ensuring even heat dissipation and the highest electrical integrity
- Distributor replacement kit contains the appropriate core and coil with color coded leads, a properly rated capacitor and igniter (if required) and all other components required for ballast replacement
- 5-tap ballast (120, 208, 240, 277, or 480 volt) featuring a 480-volt tap

General Characteristics		Dimensions	
Ballast Type	Magnetic – Core and Coil	Length (L)	5.25 in (133 mm)
ANSI Lamp Codes	M58	Width (W)	1.25 in (32 mm)
Voltage	120/208/240/277/480	<b>Mounting Dimensions</b>	
Line Voltage Regulation(+/-)	10%	Mount Length (M)	4.6 in (117 mm)
Circuit Type	CWA	Mount Width (X or F)	
Insulation Class	180° C	Mount Slots (MS)	0.25 in (6 mm)
Type of Capacitor	Oil Filled	A	3.0
Capacitance	15 Mfd GECAP-15/400V-O	B	4.3
Voltage (MIN)	400	Weight	9.0 lbs
Capacitor Temperature Rating	100°C (212°F)	Exit Type	Side
GE Igniter		Nominal Length	3.2 in (83 mm)
Sound Rating		Frame Size (H x L)	2.813 in x 3.939 in
Additional Info		<b>Lead Lengths</b>	
		Orange	
		Violet & Black	
		Violet/White	
		Black/Yellow	

Specifications by lamp and line voltage						
Lamp	Specifications by line voltage					
	120	208	240	277	480	
M58 250W Quartz Metal Halide	System Wattage (W)	280	280	280	280	280
	Nominal Current	2.50A	1.40A	1.25A	1.10A	0.65A
	Ballast Factor	1	1	1	1	1
	Ballast Efficiency Factor	0.89	0.89	0.89	0.89	0.89
	Max Input Current	2.60A	1.60A	1.30A	1.20A	0.70A
	Starting Current	1.50A	1.00A	0.80A	0.70A	0.50A
	Open Circuit Voltage	290V	290V	290V	290V	290V
	Drop Out Voltage	96V	166V	192V	222V	384V
	Power Factor (>=) %	90	90	90	90	90
	Min. Starting Temp (°F/°C)	-22/-30	-22/-30	-22/-30	-22/-30	-22/-30
	Fuse Rating	8	5	4	3	2
	UL Bench Top Rise	B	B	B	C	C

# Electromagnetic HID Ballasts



## 72300 – GEM400ML5AA4-5/2

### Metal Halide

1 – 400W M59 or H33 5-Tap (120/208/240/277/480V) A1 C&C

- For 250 – 1500W Metal Halide HID Lamps
- Magnetic ballast construction ideal for a wide variety of lighting applications
- Precision-wound coils, ensuring even heat dissipation and the highest electrical integrity
- Distributor replacement kit contains the appropriate core and coil with color coded leads, a properly rated capacitor and ignitor (if required) and all other components required for ballast replacement
- 5-tap ballast (120, 208, 240, 277, or 480 volt) featuring a 480-volt tap

General Characteristics	
Ballast Type	Magnetic – Core and Coil
ANSI Lamp Codes	M59
Voltage	120/208/240/277/480
Line Voltage Regulation(+/-)	10%
Circuit Type	CWA
Insulation Class	Class H, 180°C or Class N, 200°C
Type of Capacitor	Oil Filled
Capacitance	24 Mfd GECAP-24/400V-O
Voltage (MIN)	450
Capacitor Temperature Rating	105°C (221°F)
GE Igniter	
Sound Rating	
Additional Info	

Dimensions	
Length (L)	5.25 in (133 mm)
Width (W)	1.25 in (32 mm)

Mounting Dimensions	
Mount Length (M)	4.6 in (117 mm)
Mount Width (X or F)	
Mount Slots (MS)	0.25 in (6 mm)
A	2.17
B	3.90
Weight	10.8 lbs
Exit Type	Side
Nominal Length	3.7 in (95 mm)
Frame Size (H x L)	4.25 in x 4.75 in

Electrical Characteristics	
Supply Current Frequency	60 Hz

Lead Lengths	
Orange	
Violet & Black	
Violet/White	
Black/Yellow	

Specifications by lamp and line voltage						
Lamp	Specifications by line voltage					
	120	208	240	277	480	
M59 400W Quartz Metal Halide 360W Quartz Metal Halide	System Wattage (W)	461	461	461	461	461
	Nominal Current	4.0A	2.3A	2.0A	1.75A	1.00A
	Ballast Factor	1	1	1	1	1
	Ballast Efficiency Factor	0.86	0.86	0.86	0.86	0.86
	Max Input Current	4.0A	2.3A	2.0A	1.75A	1.00A
	Starting Current	3.90A	3.90A	3.90A	3.90A	3.90A
	Open Circuit Voltage	300V	300V	300V	300V	300V
	Drop Out Voltage	580V	580V	580V	580V	580V
	Power Factor (>=) %	90	90	90	90	90
	Min. Starting Temp (°F/°C)	-22/-30	-22/-30	-22/-30	-22/-30	-22/-30
	Fuse Rating	8	5	4	3	2
	UL Bench Top Rise	D or A	D or A	D or A	D or A	D or A

## Safety and Performance





## 87213 – GEM1000ML5AA5-5/2

### Metal Halide

1 – 1000W MH M47 5-Tap (120/208/240/277/480V)

- For 250 – 1500W Metal Halide HID Lamps
- Magnetic ballast construction ideal for a wide variety of lighting applications
- Precision-wound coils, ensuring even heat dissipation and the highest electrical integrity
- Distributor replacement kit contains the appropriate core and coil with color coded leads, a properly rated capacitor and igniter (if required) and all other components required for ballast replacement
- 5-tap ballast (120, 208, 240, 277, or 480 volt) featuring a 480-volt tap

General Characteristics		Dimensions	
Ballast Type	Magnetic – Core and Coil	Length (L)	7.75 in (197 mm)
ANSI Lamp Codes	M47	Width (W)	2.75 in (70 mm)
Voltage	120/208/240/277/480	<b>Mounting Dimensions</b>	
Line Voltage Regulation(+/-)	10%	Mount Length (M)	6.1 in (155 mm)
Circuit Type	CWA	Mount Width (X or F)	
Insulation Class	Class H, 180°C or Class N, 200°C	Mount Slots (MS)	0.25 in (6 mm)
Type of Capacitor	Oil Filled	A	3.0
Capacitance	24 Mfd GECAP-24/480V-O	B	5.0
Voltage (MIN)	480	Weight	21.0 lbs
Capacitor Temperature Rating	105°C (221°F)	Exit Type	Side
GE Igniter		Nominal Length	3.7 in (95 mm)
Sound Rating		Frame Size (H x L)	4.25 in x 6.00 in
Additional Info		<b>Lead Lengths</b>	
		Orange	
		Violet & Black	
		Violet/White	
		Black/Yellow	

Specifications by lamp and line voltage						
Lamp	Specifications by line voltage					
	120	208	240	277	480	
M47 1000W Quartz Metal Halide	System Wattage (W)	1,050	1,050	1,050	1,050	1,050
	Nominal Current	9.00A	5.20A	4.50A	3.90A	2.25A
	Ballast Factor	1	1	1	1	1
	Ballast Efficiency Factor	0.91	0.91	0.91	0.91	0.91
	Max Input Current	9.00A	5.20A	4.50A	3.90A	2.25A
	Starting Current	5.60A	5.60A	5.60A	5.60A	5.60A
	Open Circuit Voltage	415V	415V	415V	415V	415V
	Drop Out Voltage	96V	166V	192V	222V	384V
	Power Factor (>=) %	90	90	90	90	90
	Min. Starting Temp (°F/°C)	-22/-30	-22/-30	-22/-30	-22/-30	-22/-30
	Fuse Rating	18	10	9	7	5
	UL Bench Top Rise	D or A	D or A	D or A	D or A	D or A



## 86693 – GEM150048TAC5M5-5

### Metal Halide

1 – 1500W MH M48 480

- For 250 – 1500W Metal Halide HID Lamps
- Magnetic ballast construction ideal for a wide variety of lighting applications
- Precision-wound coils, ensuring even heat dissipation and the highest electrical integrity
- Distributor replacement kit contains the appropriate core and coil with color coded leads, a properly rated capacitor and ignitor (if required) and all other components required for ballast replacement

General Characteristics	
Ballast Type	Magnetic – Core and Coil
ANSI Lamp Codes	M48
Voltage	480
Line Voltage Regulation(+/-)	10%
Circuit Type	CWA
Insulation Class	180°C
Type of Capacitor	Oil Filled
Capacitance	32 Mfd GECAP-32/525V-O
Voltage (MIN)	525
Capacitor Temperature Rating	100°C (212°F)
GE Igniter	
Sound Rating	
Additional Info	

Dimensions	
Length (L)	7.75 in (197 mm)
Width (W)	2.75 in (70 mm)
Mounting Dimensions	
Mount Length (M)	6.1 in (155 mm)
Mount Width (X or F)	
Mount Slots (MS)	0.25 in (6 mm)
A	4.0
B	6.0
Weight	30.0 lbs
Exit Type	Side
Nominal Length	5.2 in (133 mm)
Frame Size (H x L)	4.25 in x 6.00 in

Electrical Characteristics	
Supply Current Frequency	60 Hz

Specifications by lamp and line voltage		
Lamp	Specifications by line voltage	
	480	
	System Wattage (W)	1,581
	Nominal Current	3.10A
	Ballast Factor	1
	Ballast Efficiency Factor	0.95
M48	Max Input Current	3.10A
1500W Quartz	Starting Current	3.18A
Metal Halide	Open Circuit Voltage	449V
	Drop Out Voltage	384V
	Power Factor (>=) %	90
	Min. Starting Temp (°F/°C)	-22/-30
	Fuse Rating	10
	UL Bench Top Rise	G



## 86698 – GEM1500MLTAC5-5

### Metal Halide

1 – 1500W MH M48 Quad (120/208/240/277V)

- For 250 – 1500W Metal Halide HID Lamps
- Magnetic ballast construction ideal for a wide variety of lighting applications
- Precision-wound coils, ensuring even heat dissipation and the highest electrical integrity
- Distributor replacement kit contains the appropriate core and coil with color coded leads, a properly rated capacitor and ignitor (if required) and all other components required for ballast replacement
- Quad ballast (120, 208, 240, 277)

General Characteristics	
Ballast Type	Magnetic – Core and Coil
ANSI Lamp Codes	M48
Voltage	240/277
Line Voltage Regulation(+/-)	10%
Circuit Type	CWA
Insulation Class	180°C
Type of Capacitor	Oil Filled
Capacitance	32 Mfd GECAP-32/525V-O
Voltage (MIN)	525
Capacitor Temperature Rating	100°C (212°F)
GE Igniter	
Sound Rating	
Additional Info	

Electrical Characteristics	
Supply Current Frequency	60 Hz

Dimensions	
Length (L)	7.75 in (197 mm)
Width (W)	2.75 in (70 mm)
Mounting Dimensions	
Mount Length (M)	6.1 in (155 mm)
Mount Width (X or F)	
Mount Slots (MS)	0.25 in (6 mm)
A	4.0
B	6.0
Weight	30.0 lbs
Exit Type	Side
Nominal Length	5.2 in (133 mm)
Frame Size (H x L)	4.25 in x 6.00 in

Specifications by lamp and line voltage					
Lamp	Specifications by line voltage				
		120	208	240	277
M48 1500W Quartz Metal Halide	System Wattage (W)	1,602	1,602	1,602	1,602
	Nominal Current	13.70A	7.70A	6.80A	6.00A
	Ballast Factor	1	1	1	1
	Ballast Efficiency Factor	0.94	0.94	0.94	0.94
	Max Input Current	13.70A	7.70A	6.80A	6.00A
	Starting Current	12.95A	7.46A	6.52A	5.75A
	Open Circuit Voltage	440V	440V	440V	440V
	Drop Out Voltage	96V	166V	192V	222V
	Power Factor (>=) %	90	90		90
	Min. Starting Temp (°F/°C)	-22/-30	-22/-30	-22/-30	-22/-30
	Fuse Rating	40	25	20	20
	UL Bench Top Rise	A	A	A	A

# Electromagnetic HID Ballasts



## 67345 – GEP320MLTAA4-5/2

### Pulse Start

1 – 320W PS M132 or 154 Quad (120/208/240/277V)

- For 175 – 1000W Pulse Start Metal Halide HID Lamps
- Magnetic ballast construction ideal for a wide variety of lighting applications
- Precision-wound coils, ensuring even heat dissipation and the highest electrical integrity
- Distributor replacement kit contains the appropriate core and coil with color coded leads, a properly rated capacitor and ignitor (if required) and all other components required for ballast replacement
- Quad ballast (120, 208, 240, 277)

General Characteristics	
Ballast Type	Magnetic – Core and Coil
ANSI Lamp Codes	M154, M132
Voltage	120/208/240/277
Line Voltage Regulation(+/-)	10%
Circuit Type	CWA
Insulation Class	Class H, 180°C or Class N, 200°C
Type of Capacitor	Oil Filled
Capacitance	21 Mfd GECAP-21/345V-O
Voltage (MIN)	370
Capacitor Temperature Rating	105°C (221°F)
GE Igniter	MH350-1A
Sound Rating	
Additional Info	

Dimensions	
Length (L)	5.25 in (133 mm)
Width (W)	1.25 in (32 mm)
Mounting Dimensions	
Mount Length (M)	4.6 in (117 mm)
Mount Slots (MS) Mount Width (X or F)	0.25 in (6 mm)
A	1.89
B	3.60
Weight	9.50 lbs
Exit Type	Side
Nominal Length	3.7 in (95 mm)
Frame Size (H x L)	4.25 in x 4.75 in

Electrical Characteristics	
Supply Current Frequency	60 Hz

Specifications by lamp and line voltage					
Lamp	Specifications by line voltage	120	208	240	277
M48 1500W Quartz Metal Halide	System Wattage (W)	370	370	370	370
	Nominal Current	3.10A	1.80A	1.55A	1.34A
	Ballast Factor	1	1	1	1
	Ballast Efficiency Factor	0.86	0.86	0.86	0.86
	Max Input Current	3.10A	1.80A	1.55A	1.34A
	Starting Current	3.20A	3.20A	3.20A	3.20A
	Open Circuit Voltage	270V	270V	270V	270V
	Drop Out Voltage	540V	540V	540V	540V
	Power Factor (>=) %	90	90	90	90
	Min. Starting Temp (°F/°C)	-20/-30	-20/-30	-20/-30	-20/-30
	Fuse Rating	7	4	3	3
	UL Bench Top Rise	A or B	A or C	A or C	A or C

## Safety and Performance





## 67347 – GEP400MLTAA4-5/2

### Pulse Start

1 – 400W PS M135/M155 Quad (120/208/240/277V)

- For 175 – 1000W Pulse Start Metal Halide HID Lamps
- Magnetic ballast construction ideal for a wide variety of lighting applications
- Precision-wound coils, ensuring even heat dissipation and the highest electrical integrity
- Distributor replacement kit contains the appropriate core and coil with color coded leads, a properly rated capacitor and igniter (if required) and all other components required for ballast replacement
- Quad ballast (120, 208, 240, 277)

General Characteristics	
Ballast Type	Magnetic – Core and Coil
ANSI Lamp Codes	M135/M155
Voltage	120/208/240/277
Line Voltage Regulation(+/-)	10%
Circuit Type	CWA
Insulation Class	Class H, 180°C or Class N, 200°C
Type of Capacitor	Oil Filled
Capacitance	24 Mfd GECAP-24/400V-O
Voltage (MIN)	450
Capacitor Temperature Rating	105°C (221°F)
GE Igniter	MH350-1A
Sound Rating	
Additional Info	

Electrical Characteristics	
Supply Current Frequency	60 Hz

Dimensions	
Length (L)	5.25 in (133 mm)
Width (W)	1.25 in (32 mm)
Mounting Dimensions	
Mount Length (M)	4.6 in (117 mm)
Mount Width (X or F)	
Mount Slots (MS)	0.25 in (6 mm)
A	2.17
B	3.90
Weight	10.80 lbs
Exit Type	Side
Nominal Length	4.6 in (119 mm)
Frame Size (H x L)	4.25 in x 4.75 in

Specifications by lamp and line voltage					
Lamp	Specifications by line voltage				
	120	208	240	277	
M135/M155	System Wattage (W)	457	457	457	457
	Nominal Current	4.00A	2.30A	2.00A	1.75A
	Ballast Factor	1	1	1	1
	Ballast Efficiency Factor	0.87	0.87	0.87	0.87
	Max Input Current	4.00A	2.30A	2.00A	1.75A
	Starting Current	3.80A	3.80A	3.80A	3.80A
	Open Circuit Voltage	300V	300V	300V	300V
	Drop Out Voltage	580V	580V	580V	580V
	Power Factor (>=) %	90	90	90	90
	Min. Starting Temp (°F/°C)	-20/-30	-20/-30	-20/-30	-20/-30
	Fuse Rating	8	5	4	3
	UL Bench Top Rise	A or D	A or D	A or D	A or D

# Electromagnetic HID Ballasts



## 87094 – GES150MLTLC3D-5

### High Pressure Sodium

1 – 150W HPS S55 Quad (120/208/240/277V)

- For 50 – 150W High Pressure Sodium HID Lamps
- Magnetic ballast construction ideal for a wide variety of lighting applications
- Precision-wound coils, ensuring even heat dissipation and the highest electrical integrity
- Distributor replacement kit contains the appropriate core and coil with color coded leads, a properly rated capacitor and ignitor (if required) and all other components required for ballast replacement
- Quad ballast (120, 208, 240, 277)

General Characteristics	
Ballast Type	Magnetic – Core and Coil
ANSI Lamp Codes	S55
Voltage	120/208/240/277
Line Voltage Regulation(+/-)	5%
Circuit Type	HX-HPF
Insulation Class	180° C
Type of Capacitor	Dry Film
Capacitance	14 Mfd GECAP-14/280V-D
Voltage (MIN)	280
Capacitor Temperature Rating	100°C (212°F)
GE Igniter	HPS150-3A
Sound Rating	
Additional Info	

Electrical Characteristics	
Supply Current Frequency	60 Hz

Dimensions	
Length (L)	5.25 in (133 mm)
Width (W)	1.25 in (32 mm)
Mounting Dimensions	
Mount Length (M)	4.6 in (117 mm)
Mount Width (X or F)	
Mount Slots (MS)	0.25 in (6 mm)
A	3.0
B	4.0
Weight	7.60 lbs
Exit Type	Side
Nominal Length	2.7 in (69 mm)
Frame Size (H x L)	2.813 in x 3.939 in

Specifications by lamp and line voltage					
Lamp	Specifications by line voltage	120	208	240	277
S55 150W High Pressure Sodium 250W Quartz Metal Halide	System Wattage (W)	175	175	175	175
	Nominal Current	1.60A	0.90A	0.80A	0.70A
	Ballast Factor	1	1	1	1
	Ballast Efficiency Factor	1.43	1.43	1.43	1.43
	Max Input Current	2.72A	1.53A	1.34A	1.16A
	Starting Current	1.64A	0.88A	0.76A	0.65A
	Open Circuit Voltage	115V	115V	115V	115V
	Drop Out Voltage	96V	166V	192V	222V
	Power Factor (>=) %	90	90	90	90
	Min. Starting Temp (°F/°C)	-22/-30	-22/-30	-22/-30	-22/-30
	Fuse Rating	10	5	5	5
	UL Bench Top Rise	B	B	B	B

## Safety and Performance

cUL Listed UL Listed



## 87214 – GES250ML5AA4-5

### High Pressure Sodium

1 – 250W HPS S50 5-Tap (120/208/240/277/480V)

- For 250 – 1000W High Pressure Sodium HID Lamps
- Magnetic ballast construction ideal for a wide variety of lighting applications
- Precision-wound coils, ensuring even heat dissipation and the highest electrical integrity
- Distributor replacement kit contains the appropriate core and coil with color coded leads, a properly rated capacitor and ignitor (if required) and all other components required for ballast replacement
- 5-tap ballast (120, 208, 240, 277, or 480 volt) featuring a 480-volt tap

General Characteristics	
Ballast Type	Magnetic – Core and Coil
ANSI Lamp Codes	S50
Voltage	120/208/240/277/480
Line Voltage Regulation(+/-)	10%
Circuit Type	CWA
Insulation Class	180°C
Type of Capacitor	Oil Filled
Capacitance	35 Mfd GECAP-35/240V-O
Voltage (MIN)	240
Capacitor Temperature Rating	100°C (212°F)
GE Igniter	HPS400-3A
Sound Rating	
Additional Info	

Dimensions	
Length (L)	5.25 in (133 mm)
Width (W)	1.25 in (32 mm)

Mounting Dimensions	
Mount Length (M)	4.6 in (117 mm)
Mount Width (X or F)	
Mount Slots (MS)	0.25 in (6 mm)
A	2.0
B	4.0
Weight	12.0 lbs
Exit Type	Side
Nominal Length	3.7 in (95 mm)
Frame Size (H x L)	4.25 in x 4.75 in

Electrical Characteristics	
Supply Current Frequency	60 Hz

Lead Lengths	
Orange	
Violet & Black	
Violet/White	
Black/Yellow	

Specifications by lamp and line voltage						
Lamp	Specifications by line voltage					
	120	208	240	277	480	
S50 250W High Pressure Sodium	System Wattage (W)	292	292	292	292	292
	Nominal Current	2.50A	1.50A	1.30A	1.10A	0.60A
	Ballast Factor	1	1	1	1	1
	Ballast Efficiency Factor	0.86	0.86	0.86	0.86	0.86
	Max Input Current	2.50A	1.50A	1.30A	1.10A	0.60A
	Starting Current	1.59A	0.93A	0.81A	0.70A	0.40A
	Open Circuit Voltage	186V	186V	186V	186V	186V
	Drop Out Voltage	96V	166V	192V	222V	384V
	Power Factor (>=) %	90	90	90	90	90
	Min. Starting Temp (°F/°C)	-22/-30	-22/-30	-22/-30	-22/-30	-22/-30
	Fuse Rating	8	5	4	4	4
	UL Bench Top Rise	C	C	B	B	B

# Electromagnetic HID Ballasts



## 63066 – GES400ML5AA4-5 (replaces 87215)

### High Pressure Sodium

1 – 400W HPS S51 5-Tap (120/208/240/277/480V)

- For 250 – 1000W High Pressure Sodium HID Lamps
- Magnetic ballast construction ideal for a wide variety of lighting applications
- Precision-wound coils, ensuring even heat dissipation and the highest electrical integrity
- Distributor replacement kit contains the appropriate core and coil with color coded leads, a properly rated capacitor and ignitor (if required) and all other components required for ballast replacement
- 5-tap ballast (120, 208, 240, 277, or 480 volt) featuring a 480-volt tap

General Characteristics	
Ballast Type	Magnetic – Core and Coil
ANSI Lamp Codes	S51
Voltage	120/208/240/277/480
Line Voltage Regulation(+/-)	10%
Circuit Type	CWA
Insulation Class	180°C
Type of Capacitor	Oil Filled
Capacitance	55 Mfd GECAP-55/240V-O
Voltage (MIN)	240
Capacitor Temperature Rating	100°C (212°F)
GE Igniter	HPS400-3A 86641
Sound Rating	
Additional Info	

Dimensions	
Length (L)	5.25 in (133 mm)
Width (W)	1.25 in (32 mm)

Mounting Dimensions	
Mount Length (M)	4.6 in (117 mm)
Mount Width (X or F)	
Mount Slots (MS)	0.25 in (6 mm)
A	2.0
B	4.0
Weight	15.0 lbs
Exit Type	Side
Nominal Length	4.2 in (108 mm)
Frame Size (H x L)	4.25 in x 4.75 in

Electrical Characteristics	
Supply Current Frequency	60 Hz

Lead Lengths	
Orange	
Violet & Black	
Violet/White	
Black/Yellow	

Specifications by lamp and line voltage						
Lamp	Specifications by line voltage					
	120	208	240	277	480	
S51 400W High Pressure Sodium	System Wattage (W)	472	472	472	472	472
	Nominal Current	4.00A	2.20A	2.00A	1.70A	1.00A
	Ballast Factor	1	1	1	1	1
	Ballast Efficiency Factor	0.85	0.85	0.85	0.85	0.85
	Max Input Current	4.00A	2.20A	2.00A	1.70A	1.00A
	Starting Current	2.87A	1.66A	1.44A	1.25A	0.72A
	Open Circuit Voltage	191V	191V	191V	191V	191V
	Drop Out Voltage	96V	166V	192V	222V	384V
	Power Factor (->) %	90	90	90	90	90
	Min. Starting Temp (°F/°C)	-22/-30	-22/-30	-22/-30	-22/-30	-22/-30
	Fuse Rating	15	8	8	5	5
	UL Bench Top Rise	C	C	C	C	C

## Safety and Performance

cUL Listed UL Listed



## 87218 – GES1000ML5AA5-5

### High Pressure Sodium

1 – 1000W HPS S52 5-Tap (120/208/240/277/480V)

- For 250 – 1000W High Pressure Sodium HID Lamps
- Magnetic ballast construction ideal for a wide variety of lighting applications
- Precision-wound coils, ensuring even heat dissipation and the highest electrical integrity
- Distributor replacement kit contains the appropriate core and coil with color coded leads, a properly rated capacitor and ignitor (if required) and all other components required for ballast replacement
- 5-tap ballast (120, 208, 240, 277, or 480 volt) featuring a 480-volt tap

General Characteristics	
Ballast Type	Magnetic – Core and Coil
ANSI Lamp Codes	S52
Voltage	120/208/240/277/480
Line Voltage Regulation(+/-)	10%
Circuit Type	CWA
Insulation Class	180°C
Type of Capacitor	Oil Filled
Capacitance	26 Mfd GECAP-26/525V-O
Voltage (MIN)	525
Capacitor Temperature Rating	100°C (212°F)
GE Igniter	HPS1000-4B
Sound Rating	
Additional Info	

Electrical Characteristics	
Supply Current Frequency	60 Hz

Dimensions	
Length (L)	7.75 in (197 mm)
Width (W)	2.75 in (70 mm)
Mounting Dimensions	
Mount Length (M)	6.1 in (155 mm)
Mount Width (X or F)	
Mount Slots (MS)	0.25 in (6 mm)
A	4.0
B	6.0
Weight	28.0 lbs
Exit Type	Side
Nominal Length	4.7 in (121 mm)
Frame Size (H x L)	4.25 in x 6.00 in
Lead Lengths	
Orange	
Violet & Black	
Violet/White	
Black/Yellow	

Specifications by lamp and line voltage						
Lamp	Specifications by line voltage					
	120	208	240	277	480	
S52 1000W High Pressure Sodium	System Wattage (W)	1,102	1,102	1,102	1,102	1,102
	Nominal Current	9.50A	5.50A	4.70A	4.10A	2.40A
	Ballast Factor	1	1	1	1	1
	Ballast Efficiency Factor	0.91	0.91	0.91	0.91	0.91
	Max Input Current	9.50A	5.50A	4.70A	4.10A	2.40A
	Starting Current	5.75A	3.40A	2.90A	2.60A	1.80A
	Open Circuit Voltage	435V	435V	435V	435V	435V
	Drop Out Voltage	96V	166V	192V	222V	384V
	Power Factor (>=) %	90	90	90	90	90
	Min. Starting Temp (°F/°C)	-22/-30	-22/-30	-22/-30	-22/-30	-22/-30
	Fuse Rating	20	15	10	10	8
	UL Bench Top Rise	D	D	D	D	D



## Lamp Size/Diameter

The diameter of a lamp, at its maximum dimension, is expressed in eighths of an inch. Examples: The diameter of an A19 lamp is 19-eighths of an inch, or 2-3/8", at its widest point. A T8 lamp has a diameter of 8-eighths, or one inch.

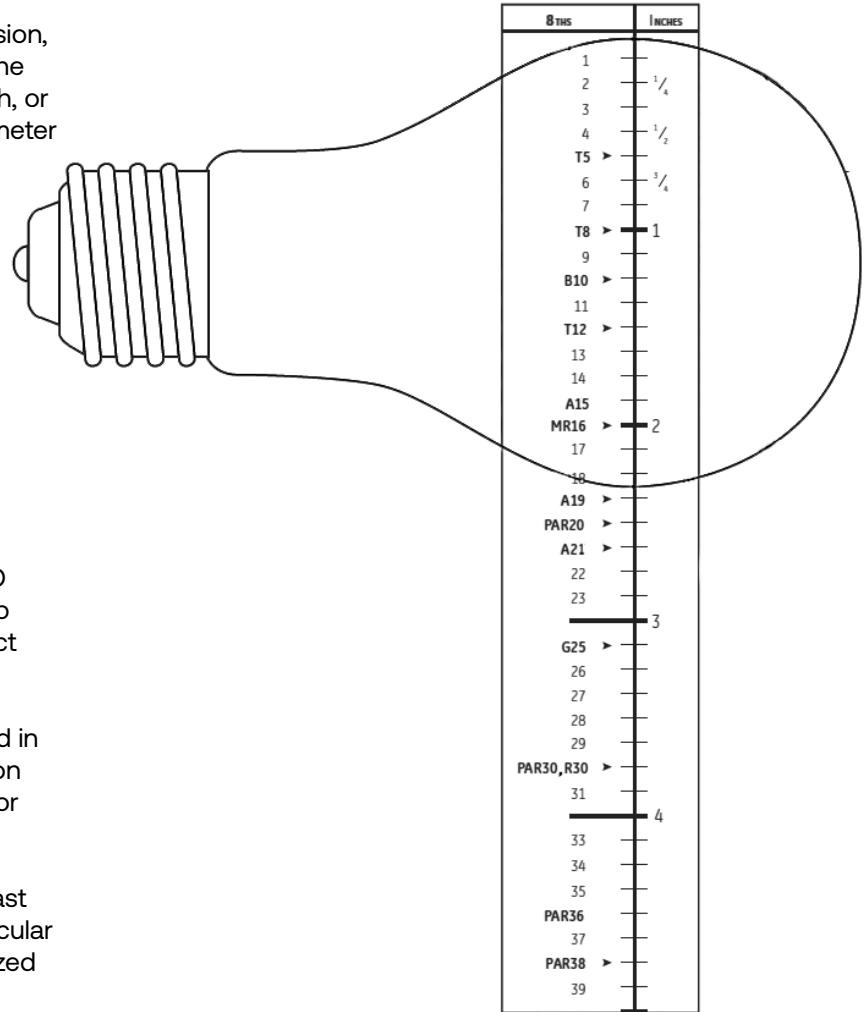

## Important Notice

This catalog is a compilation of accumulated data. Additional information is constantly being uncovered through research and testing, which may modify the data given herein. This is particularly true of newer lamps and ballasts. Accordingly, SPECIFICATIONS ARE SUBJECT TO CHANGE WITHOUT NOTICE. For the latest lamp and ballast design data and information, contact your Current representative.

The data and suggested applications contained in this catalog, as well as any additional information our representative may be able to furnish, are for general information only and are not intended and should not be taken as representations or warranties as to the suitability of a lamp or ballast for any particular application or use in any particular equipment, nor are our representatives authorized to make any such warranties. Applications and conditions of use are many and varied, and beyond our control. We cannot possibly have the same degree of knowledge that the purchaser has with respect to the design of his equipment and the conditions of its use. Therefore, it is up to the purchaser to make its own determination as to the suitability of a lamp or ballast for his intended application or use and to assume the responsibility for that determination.

Current desires to supply the best possible products at all times. For this reason, Current reserves the right to make changes in its products and to introduce new products or discontinue existing ones without notice.



## Ambient Temperature

Ambient temperature which refers to the temperature inside the fixture in the air surrounding the fluorescent lamp or LED. Fluorescent lamp light output and LED life are affected by the ambient temperature.

## Amperes

("Amps") A measure of electrical current. In incandescent lamps, the current is related to voltage and power as follows: Watts (power) = Volts x Amps (current).

## ANSI (American National Standards Institute)

A consensus-based organization which coordinates voluntary standards for the physical, electrical and performance characteristics of lamps, ballasts, luminaires and other lighting and electrical equipment.

## ANSI Ballast Type

A reference to the ANSI document describing the lamp which also lists the characteristics of the ballast required to operate the lamp. Technically, therefore, it is incorrect to refer to "Ballast Type" with the ANSI code but this misuse is common. The following naming system is used: H – mercury lamps; M – metal halide lamps; S – high pressure sodium lamps; L – low pressure sodium lamps.

## Ballast

An auxiliary piece of equipment required to start and to properly control the flow of current to gas discharge light sources such as fluorescent and high intensity discharge (HID) lamps. Typically, magnetic ballasts (also called electromagnetic ballasts) contain copper windings on an iron core while electronic ballasts are smaller and more efficient and contain electronic components.

## Ballast Efficacy Factor (BEF)

Defined as ballast factor x 100 divided by input watts. The value is used to evaluate various lighting systems based on light output and power input. The BEF can only be used to compare systems operating the same type and quantity of lamps.

## Ballast Factor (BF)

This is the percentage of a lamp's rated lumen output that can be expected when operated on a specific, commercially available ballast. Note that the "rated output" is sometimes measured on a reference ballast unlike ones that actually operate the lamp in the field. For example, a ballast with a ballast factor of 0.93 will result in the lamp's emitting 93% of its rated lumen output. A ballast with a lower BF results in less light output and also generally consumes less power.

## Beam Angle

The angular dimension of the cone of light from reflectorized lamps (such as R and PAR types) encompassing the central part of the beam out to the angle where the intensity is 50% of maximum. The beam angle (sometimes called "beam spread") is often part of the ordering code for reflectorized lamps. Example: The 50PAR30/HIR/NFL25 is a 50 watt PAR30 narrow flood lamp with a beam angle of 25 degrees, i.e. 12.5 degrees on either side of the center (see FIELD ANGLE).

## Bi-Pin

Any base with two metal pins for electrical contact. This is the typical base for a fluorescent tube of 1 to 4 feet in length. It consists of 2 prong contacts that connect into the fixture. Medium bi-pins are used with type T-8 and T-12 tubular fluorescent lamps and miniature bi-pins are used for tubular T-5 fluorescent lamps.

## Candela (cd)

The measure of luminous intensity of a source in a given direction. The term has been retained from the early days of lighting when a standard candle of a fixed size and composition was defined as producing one candela in every direction. A plot of intensity versus direction is called a candela distribution curve and is often provided for reflectorized lamps and for luminaires with a lamp operating in them.

## Candlepower

An obsolete term for luminous intensity; current practice is to refer to this simply as candelas (see CANDELA).

## Center Beam Candlepower (CBCP)

Refers to the luminous intensity at the center of the beam of a blown or pressed reflector lamp (such as a PAR lamp). Measured in candelas (see CANDELA).

## Color Rendering Index (CRI)

A measure of the ability of a light source to render object colors faithfully in comparison with a designated standard light source. Incandescent objects and daylight are both considered "standard" sources. Note that "standard" is defined for convenience in reproducibility rather than being based on user preference.

## Color Temperature (Correlated Color Temperature – CCT)

A number indicating the degree of "yellowness" or "blueness" of a white light source. Measured in Kelvins, CCT represents the temperature an incandescent object (like a filament) must reach to mimic the color of the lamp. Yellowish-white ("warm") sources, like incandescent lamps, have lower color temperatures in the 2700K–3000K range; white and bluish-white ("cool") sources, such as cool white (4100K) and natural daylight (6000K), have higher color temperatures. The higher the color temperature the whiter, or bluer, the light will be.

## Crest Factor (Lamp Current Crest Factor)

Ratio of peak to RMS for any AC waveform. Crest factor can refer to voltage crest factor or current crest factor.

## Current Type (AC/DC)

Whether the operational voltage is based on Alternating Current or Direct Current.

## Efficacy

A measurement of how effective the light source is in converting electrical energy to lumens of visible light. Expressed in lumens-per-watt (LPW), this measure gives more weight to the yellow region of the spectrum and less weight to the blue and red regions where the eye is not as sensitive. The efficiency of a light source is simply the fraction of electrical energy converted to light, i.e. watts of visible light produced for each watt of electrical power with no concern about the wavelength where the energy is being radiated. For example, a 100-watt incandescent lamp converts 7% of the electrical energy into light; discharge lamps convert 25% to 40% into light.

## Efficiency

The efficiency of a light source is simply the fraction of electrical energy converted to light, i.e. watts of visible light produced for each watt of electrical power with no concern about the wavelength where the energy is being radiated. For example, a 100-watt incandescent lamp converts 7% of the electrical energy into light; discharge lamps convert 25% to 40% into light. The efficiency of a luminaire or fixture is the

## Efficiency (Continued)

percentage of the lamp lumens that actually comes out of the fixture (see LUMINAIRE EFFICIENCY).

## Electromagnetic Spectrum

A continuum of electric and magnetic radiation that can be characterized by wavelength or frequency. Visible light encompasses a small part of the electromagnetic spectrum in the region from about 380 nanometers (violet) to 770 nanometers (red) by wavelength.

## Electromagnetic Interference (EMI)

High-frequency electronic ballasts and other electronic devices can produce a small amount of radio waves that can interfere with radio and TV. Federally-mandated requirements must be met for EMI levels before an electronic device is considered FCC compliant (FCC is the Federal Communications Commission).

## Federal Communications Commission (FCC)

The U. S. federal agency that regulates emissions in the radio frequency portion of the electromagnetic spectrum. Part 18 of the FCC rules specifies electromagnetic interference (EMI) from lighting devices at frequencies greater than 450 kilohertz (kHz). A consumer-rated Class B ballast is designed for use in the home near TV and radio receivers. It produces less electrical noise that could interfere with consumer products. A Class A-rated ballast is designed for use in commercial and industrial applications that are not in the vicinity of TV and radio receivers.

## Field Angle

The angular dimension of the cone of light from reflectorized lamps (such as R and PAR types) encompassing the central part of the beam out to the angle where the intensity is 10% of maximum (see BEAM ANGLE).

## Footcandle (fc)

A unit of illuminance or light falling onto a surface. It stands for the light level on a surface one foot from a standard candle. One footcandle is equal to one lumen per square foot (see LUX).

## Frequency

Rate of alternation in an AC current. Expressed in cycles per second or Hertz (Hz).

## Glare

Visual discomfort caused by excessive brightness is called discomfort glare. If task performance is affected it is called disability glare. Glare can be direct glare or indirect (reflected) glare.

## Harmonic

An integral multiple of the fundamental frequency (60 Hz) that becomes a component of the current. Harmonic Distortion (see TOTAL HARMONIC DISTORTION or THD).

## Hertz (Hz)

Unit used to measure frequency of alteration of current or voltage, in cycles per second.

## Ignitor

An electronic device providing a high voltage pulse to initiate an electrical discharge. Typically, the ignitor is paired with or is a part of the ballast.

## Illuminance

The "density" of light (lumens/area) incident on a surface; i.e. the light level on a surface. Illuminance is measured in footcandles or lux.

## Input Voltage

Power supply voltage required for proper operation of fluorescent or HID ballast.



## Input Watts

The total power input to the ballast that includes lamp watts and ballast losses. The total power input to the fixture is the input watts to the ballast or ballasts and is the value to be used when calculating cost of energy and air conditioning loads. More than 90% of the input watts is wattage or power delivered to the lamp load with typical ballast.

## Instant Start

A type of ballast designed to start fluorescent lamps as soon as the power is applied. Most T8 fluorescent lamps are being operated on electronic instant-start ballasts. Slimline fluorescent lamps operate only on instant-start circuits.

**Kelvins** (see COLOR TEMPERATURE).

## L70, L85, etc.

L70 (or L85, etc.): The elapsed operating time over which a population of LED light sources will maintain 70% (or 85%) of its initial light output. This 70% number represents the expected median light output (which is close to the average light output) of the tested LED light source population. The value is often stated using the form L70(10K)= 50,000 Hours; this means that the LED light source's median light output reaches 70% of the initial light output at 50,000 Hours based on 10,000 hours of test data using TM-21 projection methods. When the L70 value is stated as "Reported" it means that tests have gone to at least 1/6th of the reported time as required by IESNA's TM-21 methodology. On the other hand, manufacturers will sometimes state a "Calculated" value of L70 which means they are using mathematical curve fitting and projection methods of TM-21 to project beyond 6 times the available test hours.

## Lamp Watts

Power dissipated in the lamp—some of which is converted to light, some to heat and some to ultraviolet.

## LED

Light Emitting Diode used as the primary light source in a wide array of LED lighting products. Also referred to as SSL (Solid State Lighting).

## LED Tube Beam Angle

The angle between the two opposite directions in which the average intensity is 50% of the center beam intensity as measured in the azimuthal plane perpendicular to and at the center of the linear replacement lamp axis.

**Life** (see RATED LAMP LIFE).

## Light Center Length (L.C.L.)

The distance between the center of the filament, or arc tube and a reference plane—usually the bottom of the lamp base.

## Light Emitting Diode (LED)

A solid that directly converts electrical impulses into light.

## LM79

Test procedures specified by the Illuminating Engineering Society for measurements on LED products (complete assembled systems) of lumens, watts and color in actual operating environments.

## LM80

Test procedures specified by the Illuminating Engineering Society for measuring lumen depreciation of LED sources, arrays and modules—not luminaires.

## Lumen

A measure of luminous flux or quantity of light emitted by a source.

## Lumen Depreciation, Lumen Maintenance

A measure of how well a lamp maintains its light output over time. It may be expressed numerically or as a graph of light output vs. time. The "mean lumens" of a lamp is the lumens at 40% of rated life (50% for HPS lamp).

## Lumens Per Watt (LPW)

A ratio expressing the luminous efficacy of a light source.

## Luminance

A photometric measure of "brightness" of a surface as seen by the observer, measured in candelas per square meter.

## Luminous Efficacy

The light output (lumens) of a light source divided by the total power input (watts) to that source. It is expressed in lumens per watt (see LUMENS PER WATT).

## Lux (lx)

A unit of illuminance or light falling onto a surface. Lux stands for the light level on a surface one meter from a standard candle. One lux is equal to one lumen per square meter. Ten lux approximately equals one footcandle (see FOOTCANDLE).

## Maximum Overall Length (M.O.L.)

The end-to-end measurement of a lamp, expressed in inches or millimeters.

## Mean Lumens

The average light output of a lamp over its rated life. Based on the shape of the lumen depreciation curve, for fluorescent and metal halide lamps, mean lumens are measured at 40% of rated lamp life. For mercury, high-pressure sodium and incandescent lamps, mean lumen ratings refer to lumens at 50% of rated lamp life (see LUMEN MAINTENANCE).

## Medium Base

Usually refers to the screw base typically used in household incandescent lamps. There is also the medium bi-pin base commonly used in T12 and T8 fluorescent lamps.

## Mogul Base

A screw base used on larger lamps, e.g. many HID lamps.

## PAR Lamp

PAR is an acronym for parabolic aluminized reflector. A PAR lamp, which may utilize either an incandescent filament, a halogen filament tube or an HID arc tube, is a precision pressed-glass reflector lamp. PAR lamps rely on both the internal reflector and prisms in the lens for the control of the light beam. Today it is common to refer to LED replacement products for PAR lamps as "LED PAR Lamps" even though there may be no parabolic reflector in the package.

## Parallel Lamp Operation/Parallel Wiring

Refers to ballasts that employ multiple output current paths from a single ballast to allow lamps to operate independent of one another, allowing other lamps operated by the ballast to remain lit should companion lamp(s) fail (see SERIES LAMP OPERATION).

## PCB (Polychlorinated Biphenyls)

Chemical pollutant formerly used in ballast capacitors that were part of ballasts. It is now illegal to use PCBs and most such ballasts have been replaced over time.

**Photopic** (see SCOTOPIC/PHOTOPIC).

## Power Factor (PF)

A measure of the phase difference between voltage and current drawn by an electrical device, such as a ballast or motor. Power factors can range from 0 to 1.0 with 1.0 being ideal. Power factor is sometimes expressed as a percent. Incandescent lamps have power factors close to 1.0 because they are simple "resistive" loads. The power factor of a fluorescent and HID lamp system is determined by the ballast used. "High" power factor usually means a rating of 0.9 or greater. Power companies may penalize users for using low-power-factor devices.

## Preheat Circuit

A type of fluorescent lamp-ballast circuit used with the first commercial fluorescent lamp products. A push button or automatic switch is used to preheat the lamp cathodes. Starting the lamp can then be accomplished using simple "choke" or reactor ballasts. A preheat fluorescent lamp is one in which the filament must be heated by use of a starter before the arc is created. These lamps are typically operated with electromagnetic ballasts.

## Programmed Rapid Start

Lamp starting method which preheats the lamp filaments while not allowing the lamp to ignite and then applies the open circuit voltage (OCV) to start the lamp. The user may experience a half- to one-second delay after turning on the lamps while the preheating takes place. This type of starting circuit keeps lamp end blackening to a minimum and improves lamp life performance, especially in applications where the lamps are frequently switched on and off.

## Pulse Start

A lamp that requires an HID ballast with a high-voltage ignitor to start the lamp.

## Rapid Start

Lamp starting method in which lamp filaments are heated while open circuit voltage (OCV) is applied to facilitate lamp ignition. A Rapid Start fluorescent lamp has two pins at each end connected to the filament. Some rapid start lamps may be instant-started without filament heat, for example, the F32T8 lamp.

## Rated Lamp Life

For most lamp types, rated lamp life is the length of time of a statistically large sample between first use and the point when 50% of the lamps have died (see L70 for LED Lamps).

## Reflector Lamp (R)

A light source with a built-in reflecting surface. Sometimes, the term is used to refer specifically to blown bulbs like the "R" and "ER" lamps; at other times, it includes all reflectorized lamps like PAR and MR.

## Series Lamp Operation

Refers to ballasts that employ a single current path passing through all lamps operated by the ballast. If one lamp should fail, companion lamps operated by the same ballasts will also extinguish or dim.

## Specification Series (SP) Colors

Energy-efficient, all-purpose tri-phosphor fluorescent lamp colors that provide good color rendering. The CRI for SP colors is 70 or above and varies by specific lamp type.

## Specification Series Deluxe (SPX) Colors

Energy-efficient tri-phosphor fluorescent lamp colors that provide better color rendering than Specification Series (SP) colors. The CRI for SPX colors is 80 or higher and varies by specific lamp type.

**Spectral Power Distribution (SPD)**

A graph of the radiant power emitted by a light source as a function of wavelength. SPDs provide a visual profile or "fingerprint" of the color characteristics of the source throughout the visible part of the spectrum. Also called "spectral curve" or "spectrum."

**TCLP Test**

The Toxicity Characteristic Leaching Procedure (TCLP) test, specified in the Resource Conservation and Recovery Act (RCRA) of 1990, is used to characterize fluorescent lamp waste as hazardous or nonhazardous waste. The TCLP test measures the ability of the mercury and/or lead in a lamp to leach from a landfill into ground water.

**THD** (see TOTAL HARMONIC DISTORTION).

**TM21**

Technical Memorandum developed by the Illuminating Engineering Society to provide method for projecting lumen maintenance of an LED source, array or module as a function of temperature. This will allow LED Luminaire manufacturers to predict lumen depreciation in their fixtures, based on the operating temperature of the LED in that package. See also, "L70, L85, etc."

**Total Harmonic Distortion (THD)**

A measure of the distortion of the input current on alternating current (AC) power systems caused by higher order harmonics of the fundamental frequency (60Hz in North America). THD is expressed in percent and may refer to individual electrical loads (such as a ballast) or a total electrical circuit or system in a building. ANSI C82.77 recommends THD not exceed 32% for individual commercial electronic ballasts, although some electrical utilities may require lower THDs on some systems. Excessive THDs on electrical systems can cause efficiency losses as well as overheating and deterioration of system components.

**Voltage**

A measurement of the electromotive force in an electrical circuit or device expressed in volts. Voltage can be thought of as being analogous to the pressure in a waterline.

**Watt**

A unit of electrical power. Lamps are rated in watts to indicate the rate at which they consume energy.



**Notes:**



ALBEO

DAINTREE WIRELESS CONTROLS

EVOLVE

FORUM

GE LAMPS

GTX

IMMERSION

LIGHTGRID

LIGHTSWEEP

LUMINATION

TETRA

**Current - GLI Brands**

6085 Parkland Blvd  
Mayfield Heights, OH 44124

**[LED.com/Lamps](https://www.led.com/lamps)**

© 2024 Current Lighting Solutions, LLC. All rights reserved. GE and the GE monogram are trademarks of the General Electric Company and are used under license. Information and specifications subject to change without notice. All values are design or typical values when measured under laboratory conditions.

(Rev 09/13/2024)

**GEL207-GE-Lamps-Catalog\_R16**