

Product data sheet

Specifications



Switch module, X Series, 15A, single pole, 3 way

SQR14131XX

Product availability: Stock - Normally stocked in distribution facility

Main

Range	Square D X Series
Product or Component Type	Switch
Device Application	Control
Device presentation	Mechanism with fixing frame
Aesthetic name	X Series

Complementary

Actuator	Dolly
Number of modules	1
Number of gangs	1 gang
Number of poles	1
Switch Function	3-way
[I _e] rated operational current AC	15 A
[U _e] rated operational voltage	120 V 277 V
Network type	AC
Network Frequency	60 Hz
Mounting Mode	By screws
Device mounting	Flush
Material	Plastic: strap Metal: fixing frame
Surface Finish	Matte
Connections - terminals	Phase and neutral 2 screw terminal AWG 14...AWG 12) copper Phase and neutral 2 push-in termination AWG 14), solid copper Earth 1 screw terminal copper
Earth circuit	Self earthing
Market Segment	Residential
Targeted channel	Distributor

Environment

Standards	UL 20
Product Certifications	cULus

Ordering and shipping details

Price is "List Price" and may be subject to a trade discount – check with your local distributor or retailer for actual price.

Category	US10DE909932
Discount Schedule	0DE9
GTIN	785901534617
Returnability	Yes
Country of origin	CN

Packing Units

Unit Type of Package 1	PCE
Nbr. of units in pkg.	1
Package 1 Height	4.17 in (10.6 cm)
Package 1 Width	1.50 in (3.8 cm)
Package 1 Length	1.77 in (4.5 cm)
Package weight(Lbs)	2.7 oz (77.0 g)
Unit Type of Package 2	BB1
Number of Units in Package 2	10
Package 2 Height	4.45 in (11.3 cm)
Package 2 Width	3.82 in (9.7 cm)
Package 2 Length	7.87 in (20 cm)
Package 2 Weight	31.9 oz (904 g)
Unit Type of Package 3	CAR
Number of Units in Package 3	100
Package 3 Height	8.66 in (22 cm)
Package 3 Width	9.49 in (24.1 cm)
Package 3 Length	20.08 in (51 cm)
Package 3 Weight	21.41 lb(US) (9.71 kg)

Contractual warranty

Warranty	2 years
----------	---------

Environmental Data

Schneider Electric aims to achieve Net Zero status by 2050 through supply chain partnerships, lower impact materials, and circularity via our ongoing “Use Better, Use Longer, Use Again” campaign to extend product lifetimes and recyclability.

[Environmental Data explained >](#)

[How we assess product sustainability >](#)

Environmental footprint

[Environmental Disclosure](#)

[Product Environmental Profile](#)

Use Better

Materials and Substances

Packaging made with recycled cardboard

Yes

Packaging without single use plastic

Yes

[EU RoHS Directive](#)

Compliant

REACH Regulation

[REACH Declaration](#)

California proposition 65

WARNING: This product can expose you to chemicals including: carbon black, which is known to the State of California to cause cancer, and Bisphenol A (BPA), which is known to the State of California to cause birth defects or other reproductive harm. For more information go to www.P65Warnings.ca.gov

Use Again

Repack and remanufacture

Circularity Profile

No need of specific recycling operations

Take-back

No

Technical Illustration

Wiring diagram

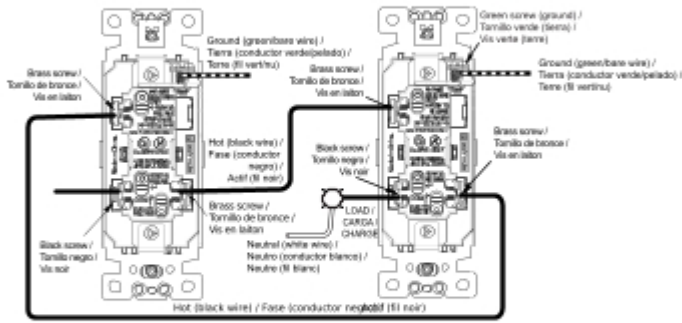

Image of product / Alternate images

Alternative

