

DIGITAL NAVIGATION

[Ordering Tree](#) [Platform](#) [Photometrics](#) [Performance Data](#)

FEATURES & SPECIFICATIONS

INTENDED USE — The CPX and CPXS Series LED is a low-glare panel featuring an external driver. This cost-effective, reliable flat panel is visually comfortable and can be recessed mounted. Suitable for many applications such as schools, offices, retail, convenience stores, hospitals, healthcare facilities and other commercial spaces. Certain airborne contaminants can diminish integrity of acrylic. [Click here for Acrylic Environmental Compatibility table for suitable uses.](#) Adjustable Lumen (AL07, AL08) and Switchable White (SWW7) configurations available. **U.S. Patent No. 10,681,784.**

CONSTRUCTION — A metal frame with satin white lens provides excellent shielding and uniform luminance. CPX's low-profile design provides increased installation flexibility especially in restricted plenum spaces. The back plate includes integral T-bar clips for installation into T-grid ceilings.

ELECTRICAL — Direct-lit Panel with Long-Life LEDs, coupled with a high-efficiency driver, provide superior illumination for extended service life. Greater than 70% LED lumen maintenance at 60,000 hours (L70>60,000). 0-10V dimming driver, dims to 10% and contains non-isolated dimming leads.

Integrated Wireless Sensor (single room control) — nLight wireless dimming with embedded multifunction occupancy/daylight sensor control (SSAIR APIR) with SSAIR Bluetooth pairing for wall switch On/Off/Dimming control or auto off when the space is unoccupied.

Integrated Smart Sensor (nLight Air Wireless Platform) — nLight AIR enabled fixtures with embedded multifunction occupancy/daylight sensor control (NAPIR) can communicate over the wireless/Bluetooth nLight control platform. It pairs to other luminaires and wall switches through our mobile app, CLAIRITY+, which allows for simple sensor adjustment.

LISTINGS — CSA certified to meet US and Canadian standards. Damp location listed. IC rated. IP5X Rated. DesignLights Consortium® (DLC) qualified product. Not all versions of this product may be DLC qualified. Please check the DLC Qualified Products List at www.designlights.org/QPL to confirm which versions are qualified. Rated for NSF/ANSI Standard 2 - Light Fixture for Splash Zone and Non Food Zone. NOM Certified.

WARRANTY — 5-year limited warranty. This is the only warranty provided and no other statements in this specification sheet create any warranty of any kind. All other express and implied warranties are disclaimed. Complete warranty terms located at: www.acuitybrands.com/support/warranty/terms-and-conditions

Note: Actual performance may differ as a result of end-user environment and application. All values are design or typical values, measured under laboratory conditions at 25 °C. The product images shown are for illustration purposes only and may not be an exact representation of the product. Specifications subject to change without notice

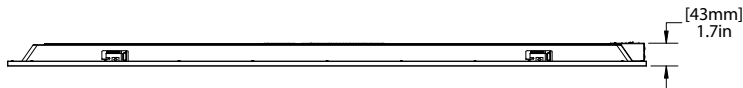

Catalog Number
Notes
Type

CPX and CPXS LED PANEL

Non-Configurable
2' x 2' and 2' x 4'

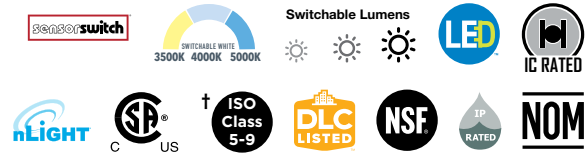

[†] Tested in accordance with ISO 14644-1; suitable for ISO Class 5-9 positive and negative pressure clean rooms.

Non-Configurable FIXTURES

ORDERING INFORMATION

Catalog Number	UPC	Description	Lumens	Color Temperature	CRI	Voltage	Wattage	Efficacy	Pallet Qty.
CPX 2X2 32L 35K SSAIR APIR	197589328837	2X2 LED Panel with Sensor	3669	3500K	80	120-277	30.1	121.9	40
CPX 2X2 32L 40K SSAIR APIR	197589328851	2X2 LED Panel with Sensor	3734	4000K	80	120-277	30.1	124.1	40
CPX 2X4 40L 35K SSAIR APIR	197589328912	2X4 LED Panel with Sensor	4818	3500K	80	120-277	36.7	131.3	20
CPX 2X4 40L 40K SSAIR APIR	197589328929	2X4 LED Panel with Sensor	4936	4000K	80	120-277	36.7	134.5	20
CPXS 22 NLTAIR2 APIR	197589371130	2X2 Switchable Panel with nLightAIR2 and Sensor	See Switchable Table	3500K/4000K/5000K	>80	120-277	See Switchable Table	See Switchable Table	20
CPXS 24 NLTAIR2 APIR	197589371147	2X4 Switchable Panel with nLightAIR2 and Sensor	See Switchable Table	3500K/4000K/5000K	>80	120-277	See Switchable Table	See Switchable Table	20
CPXS 22 E10 NLTAIR2 APIR	197589544879	2X2 Switchable Panel with E10 emergency, nLightAIR2 and Sensor	See Switchable Table	3500K/4000K/5000K	>80	120-277	See Switchable Table	See Switchable Table	20
CPXS 24 E10 NLTAIR2 APIR	197589544961	2X4 Switchable Panel with E10 emergency, nLightAIR2 and Sensor	See Switchable Table	3500K/4000K/5000K	>80	120-277	See Switchable Table	See Switchable Table	20

SWITCHABLE PERFORMANCE DATA

Switchable Table						
Size(ft)	Nomenclature	Lumen Package	CCT	Lumen	Wattage	Efficacy
2x2	CPXS 22 NLTAIR2 APIR	Low Lumen	3500K	2587	20.5	126.2
			4000K	2664	19.3	137.8
			5000K	2609	20.1	129.6
		Med Lumen	3500K	3432	27.7	124.1
			4000K	3587	26	138.1
			5000K	3486	26.9	129.5
		High Lumen	3500K	4322	34.9	123.7
			4000K	4557	32.8	139.1
			5000K	4382	34	128.8
2x4	CPXS 24 NLTAIR2 APIR	Low Lumen	3500K	3539	25.9	136.9
			4000K	3672	24.9	147.2
			5000K	3629	25.9	140.3
		Med Lumen	3500K	4754	35.9	132.3
			4000K	4982	34.4	144.9
			5000K	4890	34.5	141.8
		High Lumen	3500K	6032	47.9	126.1
			4000K	6383	45.2	141.3
			5000K	6217	47.9	129.7

ACCESSORIES

Accessories: Order as separate catalog number.

ILBLP CP10 HE SD A	IOTA 10 Watt Constant Power, High Efficiency LED Emergency Driver for CA Title 20 †
ELA PSDMT	Remote mount tray for ILBLP battery.
DGA14	Drywall grid adapter for 1x4 recessed fixture.
DGA22	Drywall grid adapter for 2x2 recessed fixture.
DGA24	Drywall grid adapter for 2x4 recessed fixture.
1X4SMKSH	Multi-Use Surface Mount Kit 1x4, Shallow Depth
2X2SMKSH	Multi-Use Surface Mount Kit 2x2, Shallow Depth
2X4SMKSH	Multi-Use Surface Mount Kit 2x4, Shallow Depth
1X4SMKSH PAF	Multi-Use Surface Mount Kit 1X4 Post-Paint
2X2SMKSH PAF	Multi-Use Surface Mount Kit 2X2 Post-Paint
2X4SMKSH PAF	Multi-Use Surface Mount Kit 2X4 Post-Paint
PAC 2DNF 36	Panel Air Craft Kit, 2 cables with Y splitter, No Power Feed, 36 inches. Recommended for 2X2 or 1X4 Panel Fixture.
PAC 2DF 36	Panel Air Craft Kit, 2 cables with Y splitter, with Power Feed, 36 inches. Recommended for 2X2 or 1X4 Panel Fixture. ¹
PAC 4DNF 36	Panel Air Craft Kit, 4 cables, No Power Feed, 36 inches. Recommended for 2X4 or 2X2 or 1X4 Panel Fixtures.
PAC 4DF 36	Panel Air Craft Kit, 4 cables, with Power Feed, 36 inches. Recommended for 2X4 or 2X2 or 1X4 Panel Fixtures. ¹
PAC 2DNF 72	Panel Air Craft Kit, 2 cables with Y splitter, No Power Feed 72 inches. Recommended for 2X2 or 1X4 Panel Fixture.
PAC 2DF 72	Panel Air Craft Kit, 2 cables with Y splitter, with Power Feed, 72 inches. Recommended for 2X2 or 1X4 Panel Fixture. ¹
PAC 4DNF 72	Panel Air Craft Kit, 4 cables, No Power Feed, 72 inches. Recommended for 2X4 or 2X2 or 1X4 Panel Fixtures.
PAC 4DF 72	Panel Air Craft Kit, 4 cables, with Power Feed, 72 inches. Recommended for 2X4 or 2X2 or 1X4 Panel Fixtures. ¹
RK8BDP 2P U	Disconnect Plug (BDP), 2 Pole, Package of 1
RK8BDP 3P U	Disconnect Plug (BDP), 3 Pole, Package of 1
RK8BDP 2P J10	Disconnect Plug (BDP), 2 Pole, Package of 10
RK8BDP 2P J40	Disconnect Plug (BDP), 2 Pole, Package of 40

Emergency Battery Delivered Lumens

Use the formula below to determine the delivered lumens in emergency mode

$$\text{Delivered Lumens} = 1.25 \times P \times \text{LPW}$$

P = Output power of emergency driver (10W for PS1055)

LPW = Lumen per watt rating of the luminaire.

Notes

¹ For MVOLT only, not available with 347V.

Emergency Battery Pack Options - Field Installable

Battery Model Number	Wattage	Runtime (Minutes)	Lumen Output* @ 120 Lumens/Watt	Other
ILB CP07 2H A	7W	120	840	Storm Shelter/ 2-hour Runtime
ILB CP10 A	10W	90	1200	
ILBLP CP10 HE SD A	10W	90	1200	Title 20, Self Diagnostic
ILBLP CP15 HE SD A	15W	90	1800	Title 20, Self Diagnostic
ILB CP20 HE A	20W	90	2400	Title 20
ILB CP20 HE SD A	20W	90	2400	Title 20, Self Diagnostic

All the above are UL Listed products that are certified for field install external/remote to the fixture.

*Minimum delivered lumen output to assist in product selection for increased fixture mounting height.

The CP10 delivered emergency illumination outperforms legacy 1400 lumen fluorescent emergency ballast.

Please contact us at productsupportemergency@acuitybrands.com for any Emergency Battery related questions.

Lumen Maintenance

Reported Lumen Maintenance	Forecasted Lumen Maintenance
L90 @ 37k Hrs / L80 @ >60k Hrs / L70 @ >60k Hrs	L90 @ 37k Hrs / L80 @ 76k Hrs / L70 @ 120k Hrs

*Note - Reported LM based on IES standard 6X test period for LM-80 report. Forecasted LM based on TM-21 report extrapolation past 6X LM-80 testing.

CPX compatible with Sensor Switch™ [WSX-D](#) and [SPOD](#) wall switches.



WSX-D



SPOD

PHOTOMETRICS

See www.lithonia.com for photometry reports.

Fixture with Vertex

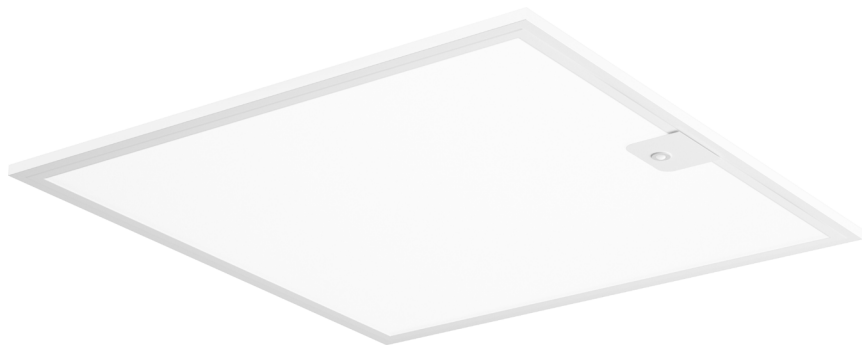

Fixture with RES7





Single Lighting Controls Platform for Indoor & Outdoor Spaces

nLIGHT® is your networked lighting controls platform, for indoor and outdoor applications, providing wired or wireless options. Scaling from room to campus-wide applications, it is the one platform that grows with your business today and tomorrow; to seamlessly address energy cost optimization, building code compliance, improved occupant comfort, and much more. nLIGHT also interfaces with DALI®, BACnet®, DMX and additional third-party devices.

nLIGHTcontrols.com

Wired Embedded Controls

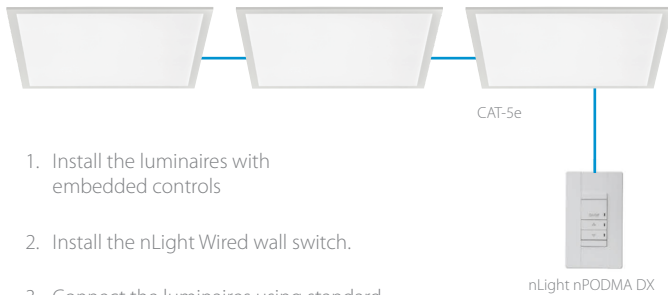

1. Install the luminaires with embedded controls
2. Install the nLight Wired wall switch.
3. Connect the luminaires using standard CAT-5e cables and the controls devices will automatically discover each other and work (plug and play).

Wireless Embedded Controls

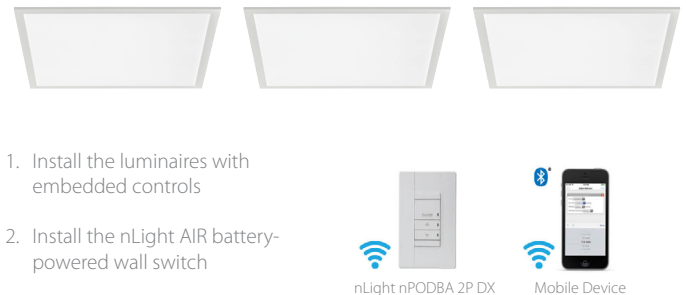

1. Install the luminaires with embedded controls
2. Install the nLight AIR battery-powered wall switch
3. Use **CLAIRITY +** mobile app to pair the fixture with the wall switch and is desired, customize the sensor settings



Performance You Can Count On

SensorSwitch™ offers standalone wired and wireless lighting controls solutions designed for room-based applications. Our products offer reliable performance and ease of installation.

Sensorswitch.com

Wired Embedded Controls

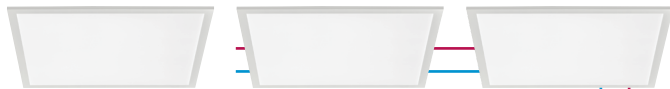

CPX Series

1. Install the luminaires with embedded controls
2. Install and wire the wall switch to power.
3. Connect load and 0-10 dimming wires from the wall switch to the luminaires.



SensorSwitch
WSXA D

Wireless Embedded Controls



CPX Series

1. Install the luminaires with embedded controls
2. Insert the pairing tool into the pinhole on the wall switch; press and hold any button for 6 seconds.
3. Once paired, each fixture will individually dim down to 10% brightness. All products will be fully functional.



SensorSwitch
WSXA SSA

DIMENSIONS

Length: 23.8" 60.5cm
 Width: 23.8" 60.5cm
 Depth: 1.7" 4.3cm
 Weight:
 Unit: 9.45lbs
 Unit Carton: 10.45lbs
 Master Carton: 39.5lbs

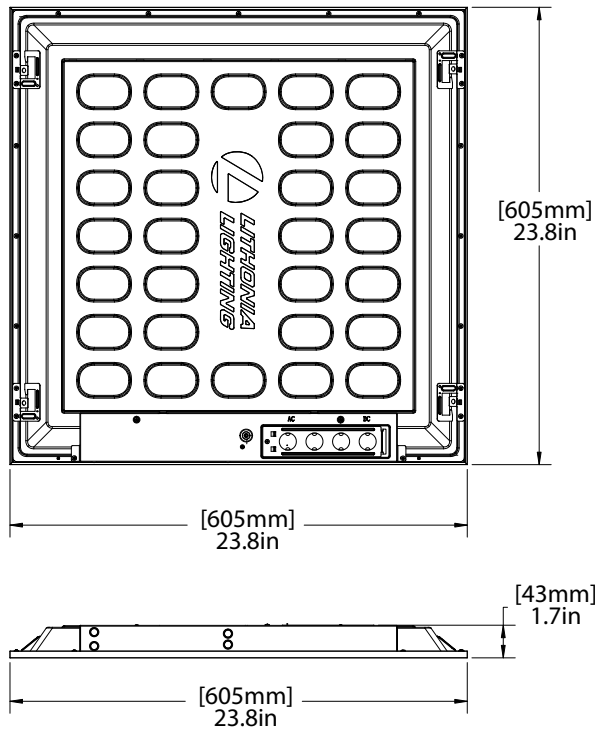

Length: 47.8 (121.4)
 Width: 23.8" 60.5cm
 Depth: 1.7" 4.3CM
 Weight:
 Unit: 17.05lbs
 Unit Carton: 19.05lbs
 Master Carton: 36.55lbs

