

Product data sheet

Specifications



miniature plug in relay, Harmony Electromechanical Relays, 12A, 2CO, without LED, with lockable test button, flat (faston type), 12V DC

RXM2AB1JD

Main

| | |
|--|----------------------------------|
| Range of product | Harmony Electromechanical Relays |
| Series name | RXM series |
| Product or component type | Plug-in relay |
| Relay type | Miniature relay |
| Contacts type and composition | 2 C/O |
| status LED | Without |
| Control type | Lockable test button |
| [Uc] control circuit voltage | 12 V DC |
| [Ithe] conventional enclosed thermal current | 12 A |
| Continuous output current | 10 A |

Complementary

| | |
|--|---|
| [Uimp] rated impulse withstand voltage | 4 kV during 1.2/50 μ s |
| [Ie] rated operational current | 12 A at 28 V (DC) NO conforming to IEC 12 A at 250 V (AC) NO conforming to IEC 6 A at 28 V (DC) NC conforming to IEC 6 A at 250 V (AC) NC conforming to IEC 12 A at 28 V (DC) conforming to UL 12 A at 277 V (AC) conforming to UL |
| Minimum switching capacity | 170 mW at 10 mA, 17 V |
| Electrical durability | 100000 cycles for resistive load |
| Rated operational voltage limits | 9.6...13.2 V DC |
| [Ui] rated insulation voltage | 250 V conforming to IEC 300 V conforming to CSA 300 V conforming to UL |
| Maximum switching voltage | 250 V conforming to IEC |
| Drop-out voltage threshold | $\geq 0.1 U_c$ |
| Load current | 12 A at 250 V AC 12 A at 28 V DC |
| Operating time | 20 ms |
| Maximum switching capacity | 3000 VA/336 W |
| Average resistance | 160 Ohm at 20 °C +/- 10 % |
| Average coil consumption | 0.9 W |
| Mechanical durability | 10000000 cycles |
| Safety reliability data | B10d = 100000 |

| | |
|--------------------------------|--|
| Operating rate | <= 1200 cycles/hour under load <= 18000 cycles/hour no-load |
| Utilisation coefficient | 20 % |
| reset time | 20 ms |
| Dielectric strength | 1300 V AC between contacts with micro disconnection 2000 V AC between coil and contact with basic insulation 2000 V AC between poles with basic insulation |
| Compatibility code | RXM |
| Protection category | RT I |
| Pollution degree | 3 |
| Operating position | Any position |
| Test levels | Level A group mounting |
| Device presentation | Complete product |
| Contacts material | AgNi |
| Shape of pin | Flat (faston type) |
| Net weight | 0.037 kg |

Environment

| | |
|--|---|
| Ambient air temperature for operation | -40...55 °C |
| IP degree of protection | IP40 conforming to IEC 60529 |
| Standards | CSA C22.2 No 14 UL 508 IEC 61810-1 |
| Product certifications | UL Lloyd's CE CSA GOST IECEE CB Scheme |
| Ambient air temperature for storage | -40...85 °C |
| Vibration resistance | 3 gn, amplitude = +/- 1 mm (f = 10...150 Hz)5 cycles in operation 5 gn, amplitude = +/- 1 mm (f = 10...150 Hz)5 cycles not operating |
| Shock resistance | 10 gn for in operation 30 gn for not operating |

Packing Units

| | |
|-------------------------------------|-----------|
| Unit Type of Package 1 | PCE |
| Number of Units in Package 1 | 1 |
| Package 1 Height | 2.200 cm |
| Package 1 Width | 2.800 cm |
| Package 1 Length | 5.000 cm |
| Package 1 Weight | 36.000 g |
| Unit Type of Package 2 | BB1 |
| Number of Units in Package 2 | 10 |
| Package 2 Height | 3.000 cm |
| Package 2 Width | 10.200 cm |
| Package 2 Length | 12.500 cm |

| | |
|------------------------------|-----------|
| Package 2 Weight | 389.000 g |
| Unit Type of Package 3 | S02 |
| Number of Units in Package 3 | 240 |
| Package 3 Height | 15.000 cm |
| Package 3 Width | 30.000 cm |
| Package 3 Length | 40.000 cm |
| Package 3 Weight | 9.878 kg |

Contractual warranty

| | |
|----------|-----------|
| Warranty | 18 months |
|----------|-----------|



Environmental Data

Schneider Electric aims to achieve Net Zero status by 2050 through supply chain partnerships, lower impact materials, and circularity via our ongoing “Use Better, Use Longer, Use Again” campaign to extend product lifetimes and recyclability.

[Environmental Data explained >](#)

[How we assess product sustainability >](#)

Environmental footprint

Total lifecycle Carbon footprint 15

Environmental Disclosure [Product Environmental Profile](#)

Use Better

Materials and Substances

Packaging made with recycled cardboard Yes

Packaging without single use plastic Yes

[EU RoHS Directive](#) Pro-active compliance (Product out of EU RoHS legal scope)

REACH Regulation [REACH Declaration](#)

California proposition 65 **WARNING:** This product can expose you to chemicals including: Nickel compounds, which is known to the State of California to cause cancer, and Di-isodecyl phthalate (DIDP), which is known to the State of California to cause birth defects or other reproductive harm. For more information go to www.P65Warnings.ca.gov

Use Again

Repack and remanufacture

End of life manual availability [End of Life Information](#)

Take-back No

Dimensions Drawings

Dimensions

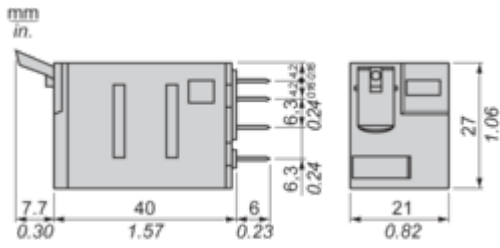

Pin Side View

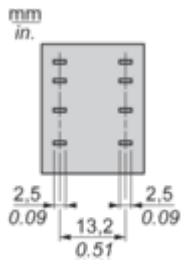

Connections and Schema

Wiring Diagram

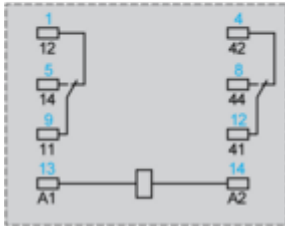
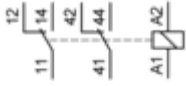

Symbols shown in blue correspond to Nema marking.

Performance Curves

Electrical Durability of Contacts

Durability (inductive load) = durability (resistive load) x reduction coefficient.

Resistive AC load

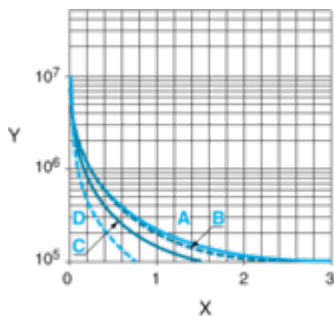

X Switching capacity (kVA)

Y Durability (Number of operating cycles)

A RXM2AB...

B RXM3AB...

C RXM4AB...

D RXM4GB...

Reduction coefficient for inductive AC load (depending on power factor cos φ)

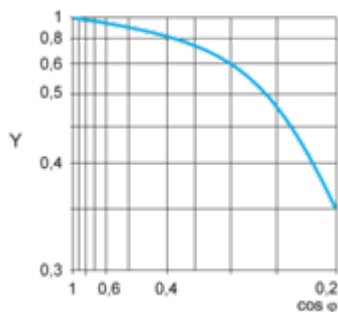

Y Reduction coefficient (A)

Maximum switching capacity on resistive DC load

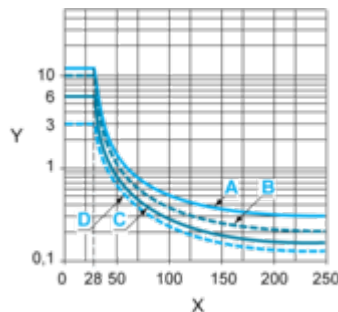

X Voltage DC

Y Current DC

A RXM2AB...

B RXM3AB...

C RXM4AB...

D RXM4GB...

Note : These are typical curves, actual durability depends on load, environment, duty cycle, etc.

For inductive load, to increase relay life cycles, please add a proper load protection circuit (eg: RC protection/Varistor/ free Wheeling diode -DC load only-).

For low level loads (below 10mA), we recommend to use RXM*GB series with bifurcated contacts relays instead.

Coil Operating Range

DC Coil Operating Range VS Ambient Temperature

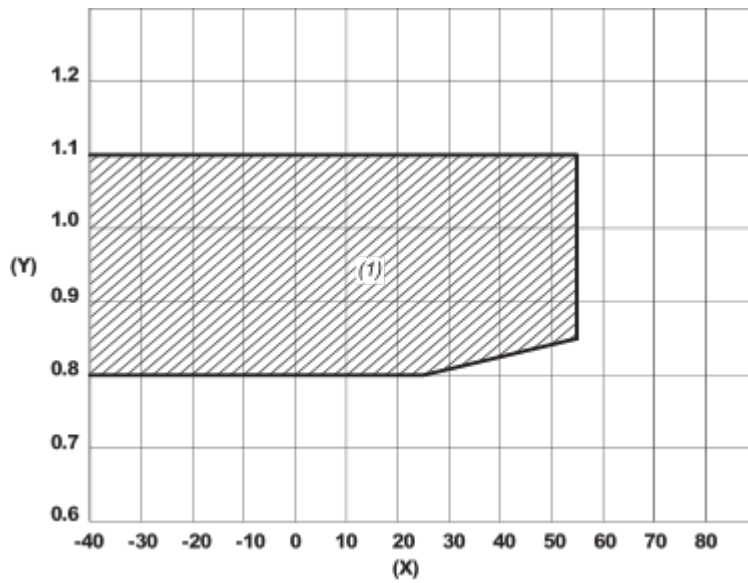

X : Ambient temperature (°C)

Y : AC coil voltage (U/Uc)

(1) Permitted operating range area

Technical Illustration

Dimensions

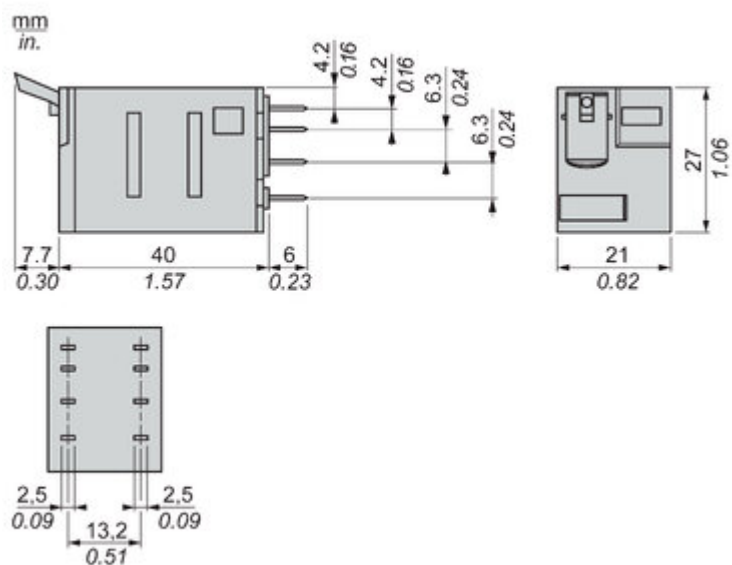

Image of product / Alternate images

Alternative





